

# COMPLEMENTI D'ARREDO

Complementos | Furnishing | Ergänzungen | Compléments

## CESTI PORTA BIANCHERIA

Contenedor de ropa |  
Hampers |  
Wäschekörbe |  
Paniers à linge

Vela  
Diagonal  
Icon  
Ecopelle  
Redmon  
Loft  
Perle  
Intrecci

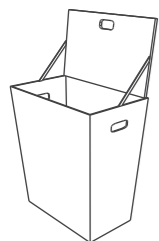

## CARRELLI E CONTENITORI

Contenedores y  
carritos |  
Trolleys and cases |  
Wäschekörbe un  
Wagen | Chariots  
et meubles de  
rangement

Mattia  
Best boy  
Ambrogio  
Tooler  
Modulo 113

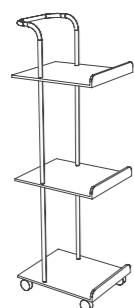

## SEDUTE DA BAGNO

Asientos para baño |  
Bath seats | Badsitze |  
Sièges de bain

Leo  
Flip  
Noni

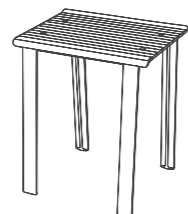

## SCOPINI

Escobillero de suelo  
| Toilet brush holder  
| Toilettenbürsten |  
Porte-balai

Gigi  
Kono  
Pepe  
Toldo  
Koko  
Frac

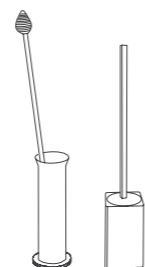

## OGGETTISTICA DA APPOGGIO

Sobremesa | Table top  
accessories | Kleines  
Zubehör | Petits  
accessoires

Vela  
Bathman  
Lem  
Tilda  
Skatto  
Classic

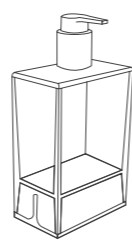

## GETTACARTA

Papelera | Waste  
Basket |  
Abfallbehälter |  
Poubelle

Karta  
Carlino  
Ecopelle  
Intrecci

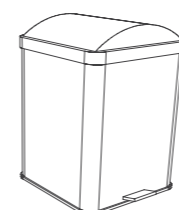

## TENDE DOCCIA

Cortinas de baño |  
Shower curtains |  
Duschvorhänge |  
Rideaux de douche

Canvass  
Linum  
Nido d'ape  
Verga  
Midas



## TAPPETI

Alfombras | Bath mat |  
Badteppich | Tapis

Reverso Classic  
Reverso Plus

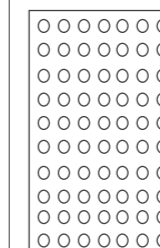

## TAPPETI DOCCIA

Alfombras para ducha |  
Mats for shower |  
Duschmatten |  
Tapis de douche

Click-clack  
Antiscivolo

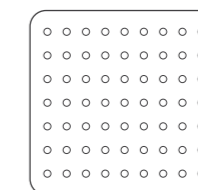

## BENESSERE

Cuidado del cuerpo |  
Body care |  
Körperpflege |  
Soin du corps

Spugne e massaggio  
Spazzole e pettini



# VELA

## Porta biancheria, con sacca interna

Contenedor de ropa, con bolsa interna  
Hamper, with internal bag  
Wäschekorb, mit Innensack  
Panier à linge, avec sac à l'intérieur

Design: Itamar Harari



**Art. 2464GR**  
cm 48,5 x 32 x h 61



**Art. 2464CR**  
cm 48,5 x 32 x h 61



**Art. 2464DB**  
cm 48,5 x 32 x h 61



**Art. 2464TO**  
cm 48,5 x 32 x h 61



### Materiali

Rivestimento esterno in eco pelle, interno in tessuto sintetico.  
Struttura in MDF.

### Materiales

Revestimiento de piel ecológica, interno en tejido sintético. Estructura en MDF. (tablero de fibra de madera)

### Materials

External synthetic leather, lining synthetic cloth. Structure of MDF fibreboard.

### Material

Außen synthetisches Leder, innen Synthetikstoff. Struktur MDF Faserplatte.

### Matériaux

Revêtement en cuir synthétique, intérieur en tissu synthétique. Structure en panneau de fibres MDF.



# DIAGONAL

## Porta biancheria

Contenedor de ropa  
Hamper  
Wäschekorb  
Panier à linge

Design: Studio KOH-I-NOOR



**Art. 2466GR**  
cm 30 x 40 x h 43/61



**Art. 2466CR**  
cm 30 x 40 x h 43/61



**Art. 2466DB**  
cm 30 x 40 x h 43/61



**Art. 2466TO**  
cm 30 x 40 x h 43/61



### Materiali

Rivestimento esterno in eco pelle, interno in tessuto sintetico.  
Struttura in MDF.

### Materiales

Revestimiento de piel ecológica, interno en tejido sintético. Estructura en MDF. (tablero de fibra de madera)

### Materials

External synthetic leather, lining synthetic cloth. Structure of MDF fibreboard.

### Material

Außen synthetisches Leder, innen Synthetikstoff. Struktur MDF Faserplatte.

### Matériaux

Revêtement en cuir synthétique, intérieur en tissu synthétique. Structure en panneau de fibres MDF.



# ICON

## Porta biancheria, con sacca interna

Contenedor de ropa, con bolsa interna  
Hamper, with internal bag  
Wäschekorb, mit Innensack  
Panier à linge, avec sac à l'intérieur

Design: Itamar Harari



**Art. 2465DB**  
cm 48 x 32 x h 61



**Art. 2465TO**  
cm 48 x 32 x h 61



### Materiali

Rivestimento esterno in  
eco pelle, interno in tessuto  
sintetico.  
Struttura in MDF.

### Materiales

Revestimiento de piel  
ecológica, interno en tejido  
sintético. Estructura en MDF.  
(tablero de fibra de madera)

### Materials

External synthetic leather,  
lining synthetic cloth.  
Structure of MDF fibreboard.

### Material

Außen synthetisches Leder,  
innen Synthetikstoff. Struktur  
MDF Faserplatte.

### Matériaux

Revêtement en cuir  
synthétique, intérieur en  
tissu synthétique.  
Structure en panneau de  
fibres MDF.



# ECOPELLE

## Porta biancheria con sacca interna, porta oggetti, gettacarta.

Contenedor de ropa con bolsa interna, portaobjetos, papelera.  
Hamper with internal bag, containers waste basket  
Wäschekorb mit Innensack, Ablageschalen, Abfallbehälter  
Panier à linge avec sac à l'intérieur, paniers, poubelle

Design: Studio KOH-I-NOOR



**Art. 2462**  
cm 43 x 26 x h 48



**Art. 2463**  
cm 48 x 30 x h 61



**Art. 2603**  
cm 23 x 23 x h 30

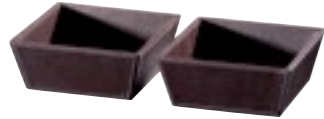

**Art. 2605**  
cm 20 x 20 x h 8



**Art. 2604**  
cm 43 x 26 x h 11

### FINITURE



### Materiali

Rivestimento esterno in eco pelle, interno in tessuto sintetico.  
Struttura in MDF.

### Materiales

Revestimiento de piel ecológica, interno en tejido sintético. Estructura en MDF. (tablero de fibra de madera)

### Materials

External synthetic leather, lining synthetic cloth. Structure of MDF fibreboard.

### Material

Außen synthetisches Leder, innen Synthetikstoff. Struktur MDF Faserplatte.

### Matériaux

Revêtement en cuir synthétique, intérieur en tissu synthétique. Structure en panneau de fibres MDF.



# REDMON

## Porta biancheria, con sacca interna

Contenedor de ropa, con bolsa interna  
Hamper, with internal bag  
Wäschekorb, mit Innensack  
Panier à linge, avec sac à l'intérieur

### Materiali

Vinile gofrato con struttura  
composita antiurto.

### Materiales

Vinilo gofrado con estructura  
antigolpes

### Materials

Embossed vinyl with shock  
resistant compound structure

### Material

Geprägtes Vinyl mit  
stoßfester Struktur.

### Matériaux

Vinyle gaufré avec structure  
antichoc.

Design: Studio KOH-I-NOOR



Art. 728  
cm 37 x 37 x h 46



Art. 2286  
cm 47 x 27 x h 60

### FINITURE



# LOFT

## Porta biancheria, sgabello con sacca interna

Contenedor de ropa y taburete con bolsa interna  
Hamper-stool with bag inside  
Wäschekorb-Hocker mit Innensack  
Panier à linge-tabouret avec sac à l'intérieur

### Materiali

RATTAN sintetico in  
polietilene, sacco in tessuto  
idrorepellente, coperchio  
imbottito e rivestito in  
ecopelle. Telaio in alluminio  
verniciato.

### Materiales

Ratán sintético en Polietilene,  
saco contenedor para la  
ropa, idrorepellente, tapa  
mullida y revestida en eco  
piel. Estructura en aluminio  
pintado.

### Materials

Synthetic Rattan of  
Polyethylene water-repellent  
bag for linen top padded  
and covered with synthetic  
leather.  
Structure in painted  
aluminium.

### Material

Synthetisches Rattan aus  
Polyethylen, Innensack aus  
wasserabweisendem Stoff,  
gepolsterter, mit Kunstleder  
bezogener Deckel.  
Struktur aus lackiertem  
Aluminium.

### Matériaux

Rattan synthétique en  
Polyéthylène, sac à linge en  
tissu hydrofuge, couvercle  
rembourré et revêtu en cuir  
synthétique.  
Structure en aluminium peint.

Design: Studio KOH-I-NOOR e Monica Cerina



Art. 2362  
cm 36 x 36 x h 47



Art. 2363  
cm 36 x 36 x h 61



### FINITURE



DB



# PERLE

## Porta biancheria con sacca interna, porta oggetti, gettacarta.

Contenedor de ropa con bolsa interna, portaobjetos, papelera.  
Hamper with internal bag, containers, waste basket  
Wäschekorb mit Innensack, Ablageschalen, Abfallbehälter  
Panier à linge avec sac à l'intérieur, paniers, poubelle

### Materiali

Rivestimento esterno in eco pelle, interno in tessuto sintetico.  
Struttura in MDF.

### Materiales

Revestimiento de piel ecológica, interno en tejido sintético. Estructura en MDF. (tablero de fibra de madera)

### Materials

External synthetic leather, lining synthetic cloth. Structure of MDF fibreboard.

### Material

Außen synthetisches Leder, innen Synthetikstoff. Struktur MDF Faserplatte.

### Matériaux

Revêtement en cuir synthétique, intérieur en tissu synthétique. Structure en panneau de fibres MDF.

Design: Studio KOH-I-NOOR



**Art. 2563**  
cm 47 x 30 x h 60



**Art. 2562**  
cm 43 x 26 x h 48



**Art. 2503**  
cm 23 x 23 x h 30



**Art. 2505**  
cm 19,6 x 19,6 x h 8



**Art. 2504**  
cm 43 x 26 x h 11

### FINITURE

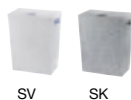

SV SK

# INTRECCI

## Porta biancheria, con sacca interna, gettacarta

Contenedor de ropa, con bolsa interna, papelera.  
Hamper, with internal bag, waste basket  
Wäschekorb mit Innensack, Abfallbehälter  
Panier à linge, avec sac à l'intérieur, poubelle

### Materiali

Rivestimento esterno in eco pelle intrecciata, interno in tessuto sintetico.  
Struttura in MDF.

### Materiales

Revestimiento externo de piel ecológica entrelazado, interno en tejido sintético. Estructura en MDF. (tablero de fibra de madera)

### Materials

External coating braided synthetic leather, lining synthetic cloth. Structure of MDF fibreboard.

### Material

Außen geflochtenes synthetisches Leder, innen Synthetikstoff. Struktur MDF Faserplatte.

### Matériaux

Revêtement en cuir synthétique tressé, intérieur en tissu synthétique. Structure en panneau de fibres MDF.

Design: Studio KOH-I-NOOR



**Art. 2963**  
cm 48,5 x 30,5 x h 60,5



**Art. 2962**  
cm 41,5 x 27 x h 50



**Art. 2903**  
cm 22 x 22 x h 28

### FINITURE

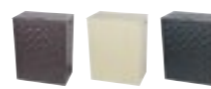

DB CR BK



# MATTIA

## Carrello

Carrito  
Trolley  
Wagen  
Chariot

Design: Studio KOH-I-NOOR



**Art. 5372**  
cm 39 x 30,5 x h 44



**Art. 5374**  
cm 39 x 30,5 x h 54



**Art. 5371**  
cm 39 x 30,5 x h 76



**Art. 5373**  
cm 39 x 30,5 x h 76

## FINITURE



### Materiali

Vassoi: tecnopolimero colorato trasparente  
Struttura: tubi in ottone cromato  
Ruote: nylon cromato

### Materiales

Bandeja: tecnopolimero coloreado transparente  
Estructura: tubo de latón cromado  
Ruedas: nylon cromadas

### Materials

Trays: transparent coloured techno-polymer  
Structure: tubes of chromed brass  
Wheels: chromed nylon

### Material

Tablets: transparent farbiger Technopolymere  
Struktur: Gestell aus verchromtem Messing  
Räder: verchromtes Nylon

### Matériaux

Tablettes: techno-polymère coloré transparent  
Structure: tiges en laiton chromé  
Roues: nylon chromé





# BEST BOY

## Carrello

Carrito  
Trolley  
Wagen  
Chariot

N I T O

Design: Michael Koenig

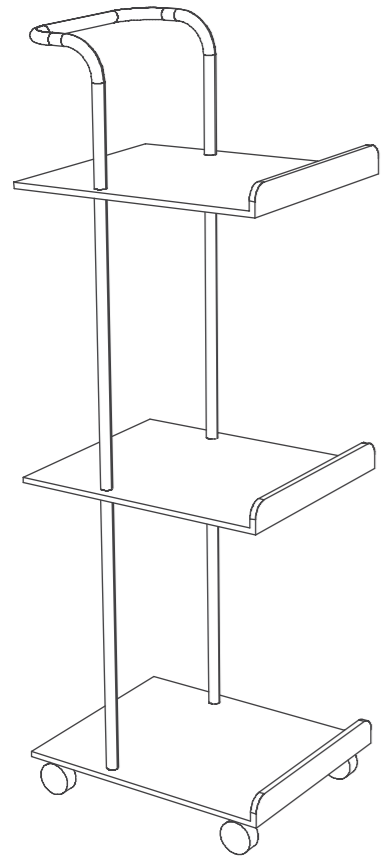

Art. 7310000  
cm 30 x 36 x h 100

### Materiali

Trolley con struttura in acciaio inox satinato e ripiani in vetro temperato verniciato.

### Materiales

Estructura en acero inoxidable y estantes en vidrio templado.

### Materials

Stainless steel structure and tempered glass shelves.

### Material

Gestell aus Edelstahl, Ablagen aus gehärtetem lackierten Glas

### Matériaux

Structure en acier inoxydable et tablettes en verre trempé.



# AMBROGIO

## Contenitore girevole sospeso con specchio.

Contenedor giratorio suspendido con espejo.  
 Pending rotating container with mirror.  
 Drehbares Hängeregal mit Spiegel  
 Structure et étagères en acier inoxydable poli et miroir en façade.

N I T O

Design: Herbert Ludwиковski

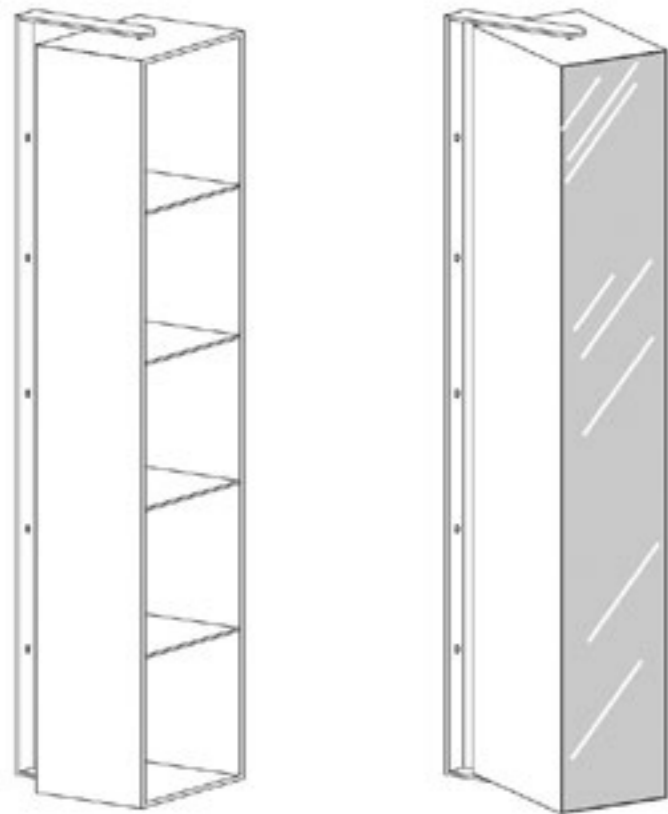

### Art. 81000 Contenitore girevole sospeso

Contenedor giratorio suspendido | Pending rotating container | Drehbares Hängeregal mit Spiegel | Étagère pivotante  
 cm 21 x 26 x h 145

### Materiali

Struttura e ripiani in acciaio inox lucido e specchio su lato frontale chiuso.

### Materiales

Estructura y estantes en acero inoxidable y espejo en la parte posterior.

### Materials

Structure and shelves in polished stainless steel and mirror on the front side.

### Material

Struktur und Regalböden aus glänzendem Edelstahl, Spiegel an der geschlossenen Vorderseite.

### Matériaux

Structure et étagères en acier inoxydable poli et miroir en façade ad.



# TOOLER

## Cornice porta oggetti.

Marco porta objetos  
Frame  
Halterahmen  
Cadre porte-objets

N I T O

Design: Tiziana Lorenzelli

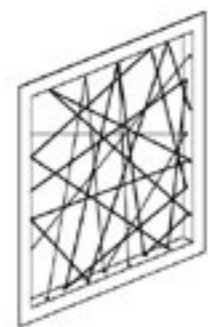

**Art. TOOL040 Cornice porta oggetti.**  
Marco porta objetos | Frame | Halterahmen | Cadre  
cm 40 x 3,5 x h 40

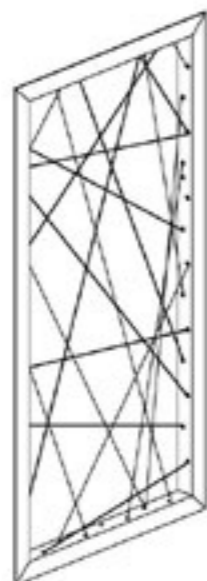

**Art. TOOL080 Cornice porta oggetti.**  
Marco porta objetos | Frame | Halterahmen | Cadre  
cm 40 x 3,5 x h 80

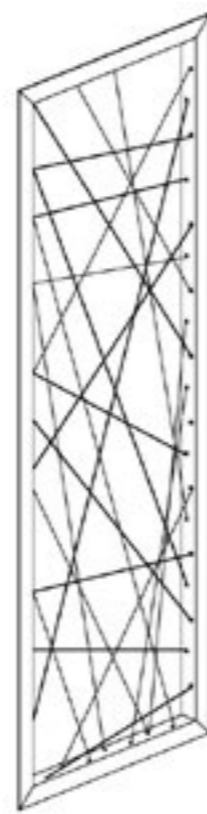

**Art. TOOL0120 Cornice porta oggetti.**  
Marco porta objetos | Frame | Halterahmen | Cadre  
cm 40 x 3,5 x h 120

### Materiali

Struttura in alluminio lucido con elastici colorati.

### Materiales

Estructura de aluminio pulido con bandas de goma.

### Materials

Structure in polished aluminum with rubber bands.

### Material

Struktur aus glänzendem Aluminium mit farbigen Gummibändern.

### Matériaux

Structure en aluminium poli avec bandes en caoutchouc.

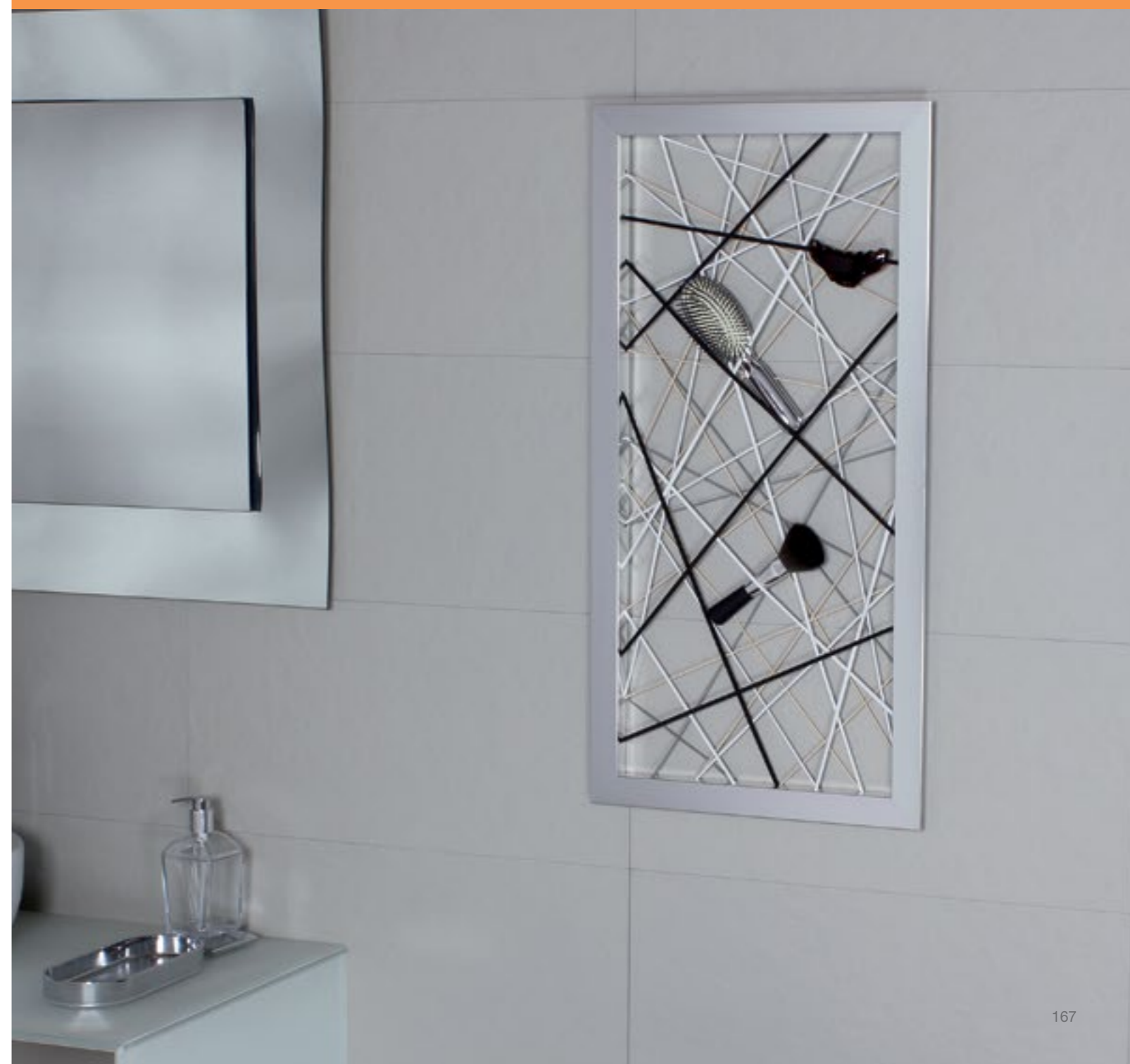

# MODULO 113

## Consolle, sgabello e piantana.

Consola, taburete y elemento de suelo.  
 Console, stool and equipped stand.  
 Konsole, Hocker und Mehrzweckständer.  
 Console tabouret et montant équipé.

**N I T O** Design: Ivano Vianello

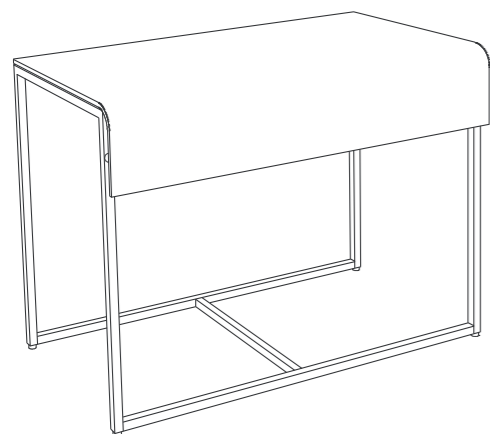

**Art. 2040 Consolle senza lavabo**  
 Consola sin lavabo | Console without sink | Konsole ohne Waschbecken | Console sans lavabo  
 cm 100 x 53 x h 73

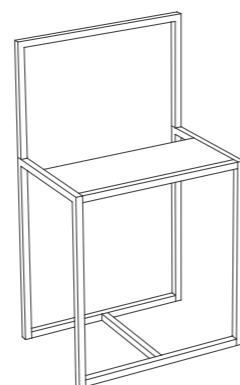

**Art. 2041 Sgabello porta salviette**  
 Taburete y toallero | Stool and towel rack | Hocker und Handtuchhalter | Tabouret et porte-serviette  
 cm 43 x 27 x h 70

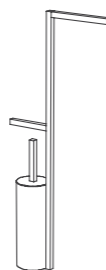

**Art. 2042 Scopino, portaserviette, carta.**  
 Escobillero, toallero portarrollos | Toilet brush, paper holder, towel rail | Toilettenbürste, Handtuchhalter, Rollenhalter | Porte - balai, papier, serviettes.  
 ø m 10 x 33 x h 80

### Materiali

Struttura in acciaio verniciato bianco. Piano in Corian® termoformato. Sedile in acciaio verniciato.

### Materiales

Estructura de acero pintado blanco. Corian® termoformado. Asiento en acero pintado.

### Materials

Structure in white painted steel. Corian® thermoformed. Seat of white painted steel.

### Material

Struktur aus weiß lackiertem Stahl. Platte aus heiß geformtem Corian® Sitz aus weiß lackiertem Stahl.

### Matériaux

Structure en acier laqué de blanc. Corian® thermoformé. Tabouret en acier laqué blanc.



**LEO** 

**Sedildoccia, supporti con finitura lucida**

Asiento de ducha, soportes con acabado brillante  
 Shower seat, supports with bright finish  
 Duschsitz, Halterung glänzend  
 Siège de douche, supports avec finition polie-brillante

Design: Studio KOH-I-NOOR e Monica Cerina

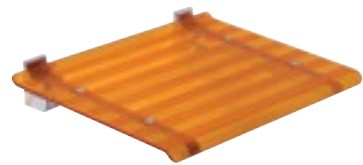

**Art. 5368A**  
cm 40 x 31 x h 7

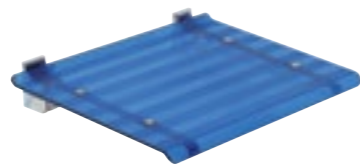

**Art. 5368B**  
cm 40 x 31 x h 7

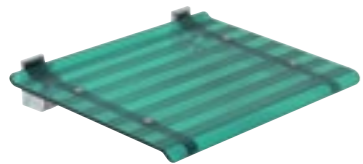

**Art. 5368P**  
cm 40 x 31 x h 7

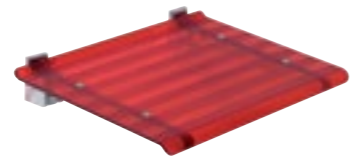

**Art. 5368R**  
cm 40 x 31 x h 7



**Art. 5368T**  
cm 40 x 31 x h 7



**Art. 5368V**  
cm 40 x 31 x h 7

**Materiali**

Sedile in policarbonato trasparente colorato o ABS bianco. Supporti in alluminio pressofuso cromato. Viti in acciaio inox.

**Materiales**

Asiento en policarbonato transparente coloreado o ABS blanco. Soportes en aluminio inyectado cromado. Tornillería en acero inoxidable.

**Materials**

Seat of transparent coloured polycarbonate or white ABS. Supports of die-cast varnished aluminium. Screws of stainless steel.

**Material**

Sitz aus transparentem Sitz aus farbig transparentem Polykarbonat oder weißem ABS. Halterung aus verchromtem Druckguss-Aluminium. Schrauben aus Edelstahl.

**Matériaux**

Siège en polycarbonate transparent coloré ou ABS blanc. Supports en aluminium moulé sous pression chromé. Vis en acier inox.



# LEO

MAX  
Kg 150

## Sgabello

Taburete con patas antideslizantes  
Stool  
Hocker  
Tabouret

Design: Studio KOH-I-NOOR e Monica Cerina



**Art. 5370A**  
cm 40 x 30 x h 46



**Art. 5370B**  
cm 40 x 30 x h 46



**Art. 5370P**  
cm 40 x 30 x h 46



**Art. 5370R**  
cm 40 x 30 x h 46



**Art. 5370T**  
cm 40 x 30 x h 46



**Art. 5370V**  
cm 40 x 30 x h 46

### Materiali

Sedile in policarbonato trasparente colorato o ABS bianco.  
Supporti in alluminio pressofuso cromato.  
Viti in acciaio inox.

### Materiales

Asiento en policarbonato transparente coloreado o ABS blanco. Soportes en aluminio inyectado cromado.  
Tornillería en acero inoxidable.

### Materials

Seat of transparent coloured polycarbonate or white ABS. Supports of die-cast varnished aluminium.  
Screws of stainless steel.

### Material

Sitz aus transparentem Sitz aus farbig transparentem Polycarbonat oder weißem ABS.  
Halierung aus verchromtem Druckguss-Aluminium.  
Schrauben aus Edelstahl.

### Matériaux

Siège en polycarbonate transparent coloré ou ABS blanc.  
Supports en aluminium moulé sous pression chromé.  
Vis en acier inox.



# NONI

## Sgabello

Taburete con patas antideslizantes  
Stool  
Hocker  
Tabouret

### Materiali

Sedile in ABS colorato, ABS cromato galvanicamente, policarbonato trasparente. Gambe in acciaio inox, viti in acciaio cromato, tappini antiscivolo.

### Materiales

Asiento en ABS coloreado, ABS cromado galvanicamente, policarbonato transparente. Patas en acero inoxidable, tornillos en acero cromado, tapones antideslizantes.

### Materials

Seat in coloured ABS, galvanized chromed ABS, transparent polycarbonate. Legs in stainless steel, screws in chromed steel, slip-proof feet.

### Material

Sitz aus farbigem ABS, galvanisch verchromtem ABS, transparentem Polykarbonat. Beine aus Edelstahl, Schrauben aus verchromtem Stahl, Füße aus rutschfestem Material.

### Matériaux

Siège en ABS coloré, ABS chromé par galvanisation, polycarbonate transparent. Pieds en acier inox, vis en acier chromé, petits patins antidérapants.

Design: Studio KOH-I-NOOR



Art. 5365  
ø cm 30 x h 42



### FINITURE



KA KB KP KR KT KK KV



# FLIP

## Sedildoccia

Asiento de ducha  
Shower seat  
Duschsitz  
Siège de douche

### Materiali

Sedile in stratificato HPL laminato ad alta pressione costituito da strati di fibre cellulosiche, spessore 12mm. Supporti in acciaio inox ISI 304 spessore 3mm. Lucidato a lastra taglio a laser. Viti in acciaio inox.

### Materiales

Asiento en tablero estratificado de alta presión HPL de 12 mm. Soportes en Inox ISI 304 de 3mm, pulido y cortado a láser. Tornillería inox.

### Materials

Seat of stratified laminated HPL, made of layers cellulosic fibres, thickness 12mm. Support of stainless steel ISI 304, thickness 3mm., polished, laser cut. Screws of stainless steel.

### Material

Sitz aus mehrschichtigem HPL Hochdrucklaminat aus Zellulosefasern, Stärke 12mm. Halterungen aus Edelstahl ISI 304, Stärke 3mm. poliert, Laserschnitt. Schrauben aus Edelstahl.

### Matériaux

Siège en HPL stratifié moulé sous pression, en fibres de cellulose épaisseur 12mm. Support en acier inox ISI 304 épaisseur 3mm. Polis et coupé au laser. Vis en acier inox.

Design: Studio KOH-I-NOOR e Pedrizzetti Associati

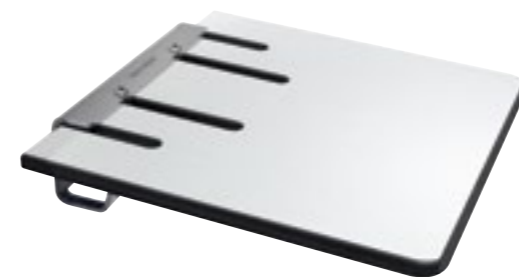

Art. 5390V  
cm 30 x 28 x h 7



# GIGI

## Scopino

Escobillero de suelo  
Toilet brush holder  
Toilettenbürste  
Porte-balai

Design: Studio KOH-I-NOOR e Monica Cerina



**Art. 5380A**  
cm 9,5 x 9,5 x h 55



**Art. 5380B**  
cm 9,5 x 9,5 x h 55



**Art. 5380P**  
cm 9,5 x 9,5 x h 55



**Art. 5380R**  
cm 9,5 x 9,5 x h 55



**Art. 5380T**  
cm 9,5 x 9,5 x h 55



**Art. 5380KK**  
cm 9,5 x 9,5 x h 55



**Art. 5380V**  
cm 9,5 x 9,5 x h 55

### Materiali

Alluminio cromato,  
ABS colorato, ABS  
cromato galvanicamente,  
policarbonato trasparente,  
contenitore interno in  
polipropilene.

### Materiales

Aluminio cromado,  
ABS coloreado, ABS  
cromado galvánicamente,  
policarbonato transparente,  
contenedor interno en  
polipropileno.

### Materials

Chromed aluminium,  
coloured ABS,galvanized  
chromed ABS, transparent  
polycarbonate, inside  
container of polypropylene

### Material

Verchromtes Aluminium,  
farbiges ABS, galvanisch  
verchromtes ABS,  
transparentes Polykarbonat,  
Innenbehälter aus  
Polypropylen

### Matériaux

Aluminium chromé, ABS  
coloré, ABS chromé par  
galvanisation, polycarbonate  
transparent, récipient interne  
en polypropylène.





# KONO

## Scopino

Escobillero de suelo  
Toilet brush holder  
Toilettenbürste  
Porte-balai

### Materiali

ABS colorato, ABS cromato galvanicamente, policarbonato trasparente, tappo antiscivolo a tenuta stagna.

### Materiales

ABS coloreado, ABS cromado galvanicamente, policarbonato transparente, tapa antideslizante y estanca.

### Materials

Coloured ABS, galvanized chromed ABS, transparent polycarbonate, anti-slip, watertight base.

### Material

Farbiges ABS, galvanisch verchromtes ABS, transparentes Polykarbonat, wasserdichter rutschfester Boden.

### Matériaux

ABS coloré, ABS chromé par galvanisation, polycarbonate transparent, fond antidérapant étanche.

Design: Studio KOH-I-NOOR



# PEPE

## Scopino

Escobillero de suelo  
Toilet brush holder  
Toilettenbürste  
Porte-balai

### Materiali

ABS colorato, ABS cromato galvanicamente, policarbonato trasparente, tappo antiscivolo, contenitore interno in polipropilene.

### Materiales

ABS coloreado, ABS cromado galvanicamente, policarbonato transparente, tapa antideslizante, contenedor interno de polipropileno.

### Materials

Coloured ABS, galvanized chromed ABS, transparent polycarbonate, anti-slip base, inside container in polypropylene.

### Material

farbiges ABS, galvanisch verchromtes ABS, transparentes Polykarbonat, rutschfester Boden, Innenbehälter aus Polypropylen.

### Matériaux

ABS coloré, ABS chromé par galvanisation, polycarbonate transparent, fond anti-glissement, récipient à l'intérieur en polypropylène.

Design: Studio KOH-I-NOOR



# TOLDO

## Scopino

Escobillero de suelo  
Toilet brush holder  
Toilettenbürste  
Porte-balai

### Materiali

ABS colorato, ABS cromato galvanicamente, SAN trasparente, contenitore interno in polipropilene.

### Materiales

ABS coloreado, ABS cromado galvanicamente, SAN transparente, contenedor interno de polipropileno.

### Materials

Coloured ABS, galvanized chromed ABS, transparent SAN, inside container of polypropylene.

### Material

farbiges ABS, galvanisch verchromtes ABS, transparentes SAN, Innenbehälter aus Polypropylen.

### Matériaux

ABS coloré, ABS chromé par galvanisation, SAN transparent, récipient à l'intérieur en polypropylène.

Design: Studio KOH-I-NOOR



Art. 5267KT  
cm 10x10 x h 36



Art. 5267VT  
cm 10x10 x h 36



Art. 5267KK  
cm 10x10 x h 36

# KOKO

## Scopino

Escobillero de suelo  
Toilet brush holder  
Toilettenbürste  
Porte-balai

### Materiali

ABS cromato galvanicamente, contenitore interno in polipropilene.

### Materiales

ABS cromado galvanicamente, contenedor interno en polipropileno.

### Materials

Galvanized chromed ABS, inside container in polypropylene

### Material

Galvanisch verchromtes ABS, Innenbehälter aus Polypropylen

### Matériaux

ABS chromé par galvanisation, récipient à l'intérieur en polypropylène.

Design: Studio KOH-I-NOOR



Art. 5050KK  
ø cm 9 x h 37



Art. 5050V  
ø cm 9 x h 37

# FRAC

## Scopino

Escobillero de suelo  
Toilet brush holder  
Toilettenbürste  
Porte-balai

N I T O

Design: Cinzia Ruggeri



Art. 57219  
ø cm 11 x h 75



Art. 57110  
ø cm 11 x h 77



Art. 57150  
ø cm 11 x h 77



Art. 57160  
ø cm 11 x h 77



Art. 57170  
ø cm 11 x h 77



Art. 57100  
ø cm 11 x h 90



Art. 57180  
ø cm 11 x h 77



Art. 57190  
ø cm 11 x h 77



Art. 57211  
ø cm 11 x h 75



Art. 57213  
ø cm 11 x h 75



Art. 57220  
ø cm 11 x h 75



Art. 57212  
ø cm 11 x h 75



Art. 57214  
ø cm 11 x h 75



Art. 57215  
ø cm 11 x h 75



Art. 57216  
ø cm 11 x h 75



Art. 57218  
ø cm 11 x h 75



Art. 57120  
ø cm 11 x h 77



Art. 57217  
ø cm 11 x h 75

### Materiali

Ottone cromato galvanicamente.

### Materiales

Vaso: laton cromado galvanicamente. Palo: Latón cromado o pintado.

### Materials

Galvanized chromed brass

### Material

Galvanisch verchromtes Messing.

### Matériaux

Laiton chromé par galvanisation.



# VELA

## Oggettistica da appoggio

Sobremesa  
Table top accessories  
Kleines Zubehör  
Accessoires à poser

### Materiali

Ceramica

### Materiales

Cerámica

### Materials

Pottery

### Material

Keramik

### Matériaux

Céramique

Design: Itamar Harari



# BATHMAN

## Oggettistica da appoggio

Sobremesa  
Table top accessories  
Kleines Zubehör  
Accessoires à poser

### Materiali

Ceramica

### Materiales

Cerámica

### Materials

Pottery

### Material

Keramik

### Matériaux

Céramique

Design: Itamar Harari



Art. 5530  
cm 13 x 9 x h 3

Art. 5538  
cm 8 x 8 x h 11,5

Art. 5557  
cm 8 x 8 x h 15

Art. 5537  
cm 26 x 12 x h 3,5

### FINITURE

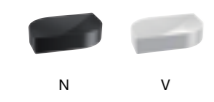

Art. 5130  
cm 12 x 9 x h 2,7

Art. 5138  
cm 9 x 5,5 x h 10,5

Art. 5157  
cm 9 x 5,5 x h 13,5

Art. 5137  
cm 26 x 12 x h 2,7

### FINITURE

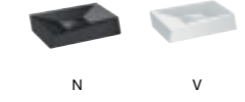

# LEM

## Oggettistica da appoggio

Sobremesa  
Table top accessories  
Kleines Zubehör  
Accessoires à poser

### Materiali

ABS cromato, ABS colorato, policarbonato.

### Materiales

ABS cromado, ABS coloreado, policarbonato.

### Materials

chromed ABS, coloured ABS, polycarbonate

### Material

verchromtes ABS, farbiges ABS, Polykarbonat

### Matériaux

ABS chromé, ABS coloré, polycarbonate

Design: Studio KOH-I-NOOR e Monica Cerina

# TILDA

## Oggettistica da appoggio

Sobremesa  
Table top accessories  
Kleines Zubehör  
Accessoires à poser

### Materiali

ABS cromato, ABS colorato, policarbonato.

### Materiales

ABS cromado, ABS coloreado, policarbonato.

### Materials

chromed ABS, coloured ABS, polycarbonate

### Material

verchromtes ABS, farbiges ABS, Polykarbonat

### Matériaux

ABS chromé, ABS coloré, polycarbonate

Design: Studio KOH-I-NOOR



Art. 5830  
cm 14,5 x 9 x h 5



Art. 5838  
cm 8,5 x 5,5 x h 13



Art. 5857  
cm 8,5 x 5,5 x h 17,5



Art. 5730  
cm 13 x 9 x h 3



Art. 5738  
cm 10 x 9 x h 11,5



Art. 5757  
cm 10 x 9 x h 18

## FINITURE

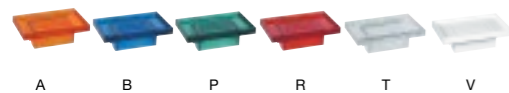

## FINITURE



# SKATTO

## Oggettistica da appoggio

Sobremesa  
Table top accessories  
Kleines Zubehör  
Accessoires à poser

### Materiali

ABS cromato, ABS colorato, policarbonato.

### Materiales

ABS cromado, ABS coloreado, policarbonato.

### Materials

chromed ABS, coloured ABS, polycarbonate

### Material

verchromtes ABS, farbiges ABS, Polykarbonat

### Matériaux

ABS chromé, ABS coloré, polycarbonate

Design: Studio KOH-I-NOOR



**Art. 5630**  
ø cm 11,3 x h 4,8



**Art. 5631**  
ø cm 11,3 x h 13



**Art. 5638**  
ø cm 9 x h 10,5



**Art. 5657**  
ø cm 9 x h 16,8

### FINITURE



# CLASSIC

## Oggettistica da appoggio

Sobremesa  
Table top accessories  
Kleines Zubehör  
Accessoires à poser

### Materiali

ABS cromato galvanicamente.

### Materiales

ABS cromado galvanicamente

### Materials

Galvanized chromed ABS

### Material

Galvanisch verchromtes ABS

### Matériaux

ABS chromé par galvanisation

Design: Studio KOH-I-NOOR



**Art. 5338**  
ø cm 7,5 x h 10



**Art. 5357**  
ø cm 7,5 x h 15



**Art. 5331**  
ø cm 11,5 x h 12



**Art. 5330**  
ø cm 11,5 x h 3,5



**Art. 5359**  
cm 25 x 13,5 x h 7



**Art. 5337**  
cm 25 x 11 h 3

### FINITURE



KK

# KARTA

## Gettacarta con pedale

Papelera a pedal  
Waste basket with pedal  
Abfallbehälter mit Pedal  
Poubelle avec pédale

### Materiali

Coperchio in ABS colorato, ABS cromato galvanicamente, policarbonato colorato trasparente. Corpo in acciaio inox lucido. Cesto interno estraibile in polipropilene.

### Materiales

Tapa en ABS coloreado, ABS cromado galvanicamente, policarbonato transparente. Cuerpo en acero inoxidable brillo. Cesto interno extraíble de polipropileno

### Materials

Cover in coloured ABS, galvanized chromed ABS, transparent coloured polycarbonate. Bright stainless steel body. Removable internal basket of polypropylene.

### Material

Deckel aus farbigem ABS, galvanisch verchromtem ABS, transparent farbigem Polykarbonat. Körper aus glänzendem Edelstahl. Herausnehmbarer Behälter aus Polypropylen.

### Matériaux

Couvercle en ABS coloré, ABS chromé par galvanisation, polycarbonate coloré transparent. Corps en acier inox brillant. Panier interne extractible en polypropylène

Design: Studio KOH-I-NOOR



**Art. 5363KA**  
cm 21 x 21 x h 29



**Art. 5363KK**  
cm 21 x 21 x h 29



**Art. 5363KB**  
cm 21 x 21 x h 29



**Art. 5363KP**  
cm 21 x 21 x h 29



**Art. 5363KR**  
cm 21 x 21 x h 29



**Art. 5363KV**  
cm 21 x 21 x h 29

# CARLINO

## Gettacarta con coperchio girevole

Papelera, tapa giratoria  
Waste basket, revolving cover  
Abfallbehälter  
Poubelle, couvercle tournant

### Materiali

Coperchio girevole in ABS cromato galvanicamente. Corpo in ABS colorato, ABS cromato galvanicamente. Fondo in materiale antiscivolo.

### Materiales

Tapa giratoria en ABS cromado galvanicamente. Cuerpo en ABS blanco o cromado galvanicamente. Fondo en material antideslizante.

### Materials

Turning top in galvanized chromed ABS. Body in coloured ABS, galvanized chromed ABS. Special bottom featuring anti-slip base.

### Material

Schwenkbarer Deckel aus galvanisch verchromtem ABS. Körper aus farbigem ABS, galvanisch verchromtem ABS. Boden aus rutschfestem Material.

### Matériaux

Couvercle pivotant en ABS chromé par galvanisation. Corps en ABS coloré, ABS chromé par galvanisation. Fond antiderapant.

Design: Studio KOH-I-NOOR



**Art. 5364**  
ø cm 24 x h 29

### FINITURE



KK KV



# ECOPELLE

## Gettacarta

Papelera  
Waste basket  
Abfallbehälter  
Poubelle

### Materiali

Rivestimento esterno in eco pelle, interno in tessuto sintetico.  
Struttura in MDF.

### Materiales

Revestimiento de piel ecológica, interno en tejido sintético. Estructura en MDF. (tablero de fibra de madera)

### Materials

External synthetic leather, lining synthetic cloth. Structure of MDF fibreboard.

### Material

Außen synthetisches Leder, innen Synthetikstoff. Struktur MDF Faserplatte.

### Matériaux

Revêtement en cuir synthétique, intérieur en tissu synthétique. Structure en panneau de fibres MDF.

Design: Studio KOH-I-NOOR



**Art. 2603DB**  
cm 23 x 23 x h 30



**Art. 2603BK**  
cm 23 x 23 x h 30



**Art. 2603OR**  
cm 23 x 23 x h 30



**Art. 2603RD**  
cm 23 x 23 x h 30



**Art. 2603CR**  
cm 23 x 23 x h 30



# INTRECCI

## Gettacarta

Papelera  
Waste basket  
Abfallbehälter  
Poubelle

### Materiali

Rivestimento esterno in eco pelle, interno in tessuto sintetico.  
Struttura in MDF.

### Materiales

Revestimiento de piel ecológica, interno en tejido sintético. Estructura en MDF. (tablero de fibra de madera)

### Materials

External synthetic leather, lining synthetic cloth. Structure of MDF fibreboard.

### Material

Außen synthetisches Leder, innen Synthetikstoff. Struktur MDF Faserplatte.

### Matériaux

Revêtement en cuir synthétique, intérieur en tissu synthétique. Structure en panneau de fibres MDF.



**Art. 2903**  
cm 22 x 22 x h 28

### FINITURE

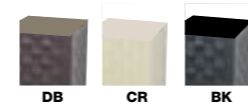



# TENDE DOCCIA

## Tenda per doccia

Cortinas de baño  
Shower curtains  
Duschvorhänge  
Rideaux de douche

Design: Studio KOH-I-NOOR

### Materiali

Tessuto 100% poliestere impermeabilizzato  
Anelli trasparenti.

### Materiales

Tejido 100% de poliéster impermeabilizado  
Anillas transparentes.

### Materials

Fabric 100% polyester water proofed  
Transparent rings

### Material

Stoff 100% Polyester imprägniert  
Transparente Ringe.

### Matériaux

Tissu 100% polyester traité imperméable  
Anneaux transparents.

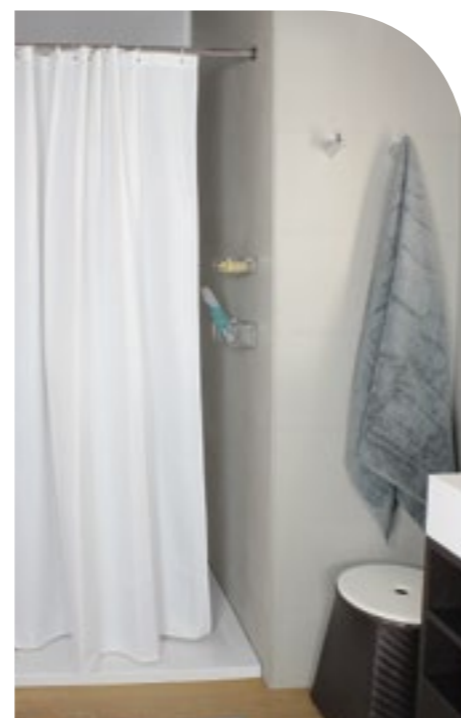

**VERGA Art. 45226**  
cm 180 x 200

**CANVASS Art. 45220**  
cm 180 x 200

**NIDO D'APE Art. 45224**  
cm 180 x 200

**LINUM Art. 45222**  
cm 180 x 200

**MIDAS GOLD Art. 45230**  
cm 180 x 200

**MIDAS SILVER Art. 45228**  
cm 180 x 200

**VERGA Art. 45227**  
cm 240 x 200

**CANVASS Art. 45221**  
cm 240 x 200

**NIDO D'APE Art. 45225**  
cm 240 x 200

**LINUM Art. 45223**  
cm 240 x 200

**MIDAS GOLD Art. 45231**  
cm 240 x 200

**MIDAS SILVER Art. 45229**  
cm 240 x 200



# REVERSO CLASSIC

## Tappeto reversibile per il bagno

Alfombras reversibles de baño  
Reversible bath mat  
Wendebadteppiche  
Tapis de bain réversible

Design: Studio KOH-I-NOOR

### Materiali

100% cotone  
pettinato e mercerizzato.  
2100gsm

### Materiales

100% algodón  
peinado y mercerizado.  
2100gsm

### Materials

100% cotton  
combed and mercerized.  
2100gsm

### Material

100% Baumwolle  
gekämmt und merzerisiert.  
2100gsm

### Matériaux

100% coton  
peigné et e mercerisé.  
2100gsm



|  |   |   |   |  |   |
|--|---|---|---|--|---|
|  |  |  |  |  |  |
| <b>Art. 35671</b><br>cm 50 x 80  | <b>Art. 35674</b><br>cm 50 x 80   | <b>Art. 35677</b><br>cm 50 x 80   | <b>Art. 35680</b><br>cm 50 x 80   | <b>Art. 35683</b><br>cm 50 x 80  | <b>Art. 35686</b><br>cm 50 x 80   |
| <b>Art. 35672</b><br>cm 60 x 100   | <b>Art. 35675</b><br>cm 60 x 100  | <b>Art. 35678</b><br>cm 60 x 100  | <b>Art. 35681</b><br>cm 60 x 100  | <b>Art. 35684</b><br>cm 60 x 100   | <b>Art. 35687</b><br>cm 60 x 100  |
| <b>Art. 35673</b><br>cm 70 x 120   | <b>Art. 35676</b><br>cm 70 x 120  |   |   |  |   |

# REVERSO PLUS

## Tappeto reversibile per il bagno

Alfombras reversibles de baño  
Reversible bath mat  
Wendebadteppiche  
Tapis de bain réversible

Design: Studio KOH-I-NOOR

### Materiali

100% cotone  
1700gsm

### Materiales

100% algodón  
1700gsm

### Materials

100% cotton  
1700gsm













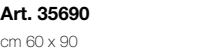
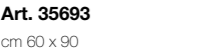

### Material

100% Baumwolle  
1700gsm

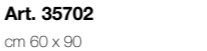
### Matériaux

100% coton  
1700gsm

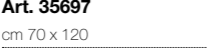
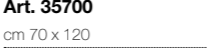

|  |   |   |   |  |   |
|--|---|---|---|--|---|
| <br><b>Art. 35689</b><br>cm 50 x 70  | <br><b>Art. 35692</b><br>cm 50 x 70  | <br><b>Art. 35695</b><br>cm 50 x 70  | <br><b>Art. 35698</b><br>cm 50 x 70  | <br><b>Art. 35701</b><br>cm 50 x 70  | <br><b>Art. 35704</b><br>cm 50 x 70  |
| <br><b>Art. 35690</b><br>cm 60 x 90  | <br><b>Art. 35693</b><br>cm 60 x 90  | <br><b>Art. 35696</b><br>cm 60 x 90  | <br><b>Art. 35699</b><br>cm 60 x 90  | <br><b>Art. 35702</b><br>cm 60 x 90  | <br><b>Art. 35705</b><br>cm 60 x 90  |
| <br><b>Art. 35691</b><br>cm 70 x 120 | <br><b>Art. 35694</b><br>cm 70 x 120 | <br><b>Art. 35697</b><br>cm 70 x 120 | <br><b>Art. 35700</b><br>cm 70 x 120 | <br><b>Art. 35703</b><br>cm 70 x 120 | <br><b>Art. 35706</b><br>cm 70 x 120 |

# CLICK-CLACK

## Materiali

Tappetino realizzato in gomma termoplastica trasparente (non contiene PVC) Antiscivolo, antimuffa, fungicida, completamente riciclabile e non inquinante. Certificazione di sicurezza TÜV  
Lavabile in lavatrice a 40°, non usare solventi o candeggina.

## Materiales

Alfombra de goma termoplástica transparente (no contiene PVC) Antideslizante, antimoho, fungicida, completamente reciclable, no contamina. Certificación de seguridad TÜV  
Lavable en lavadora a 40° C, no usar disolvente ni lejía.

## Materials

Bath mat made of thermoplastic transparent rubber (PVC free) Anti-slip, anti-mould, fungicidal, completely recyclable and not polluting. Safety certification TÜV  
Machine washable at 40° C, do not use solvents, do not bleach.

## Material

Matte aus thermoplastischem transparentem Kunststoff (enthält kein PVC) Rutschfest, Schimmel abweisend, kein Pilzbefall, komplett recyclebar, umweltschonend TÜV-Zertifikat.  
Maschinenwäsche bei 40° C, keine Lösungsmittel verwenden, nicht bleichen.

## Matériaux

Tapis en caoutchouc thermoplastique transparent (sans PVC) Antidérapant, anti-moisi, fongicide, complètement recyclable et pas polluant. Certification de sécurité TÜV.  
Lavable en machine à 40° C, ne pas utiliser dissolvants, ne pas blanchir.

Design: Studio KOH-I-NOOR

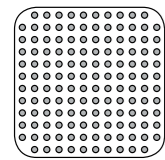

**Art. 45021**  
cm 55 x 55

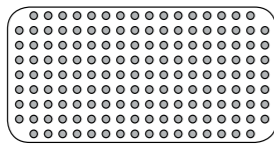

**Art. 45020**  
cm 36 x 72



# ANTISCIVOLO

## Materiali

PVC / Gomma Tappetini di sicurezza antiscivolo resistenti allo sporco, alla muffa e allo scolorimento. Lavabili in lavatrice.

## Materiales

PVC/goma Alfombras de seguridad antideslizantes, resistentes a la suciedad, al moho y a la decoloración. Lavable a máquina.

## Materials

PVC / Rubber The anti-slip safety bath mats are resistant against dirt, mould and discolouration. Machine washable.

## Material

PVC / Gummi Matten die das Ausrutschen verhindern, schmutzabweisend, resistent gegen Schimmel und Ausbleichen. Maschinenwaschbar.

## Matériaux

PVC / Caoutchouc Les tapis de sécurité antidérapants sont résistants à la saleté, au moisi et à la décoloration. Lavable en machine.

Design: Studio KOH-I-NOOR

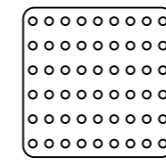

**Art. 45007**  
cm 53 x 53

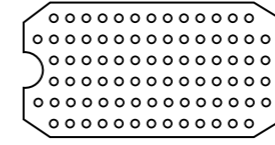

**Art. 45008**  
cm 36 x 73

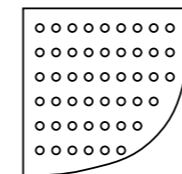

**Art. 45009-PVC**  
cm 60 x 60

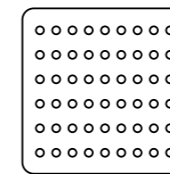

**Art. 45010-PVC**  
cm 60 x 60

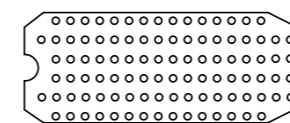

**Art. 45011-PVC**  
cm 40 x 104

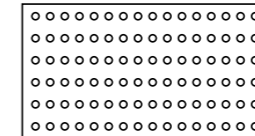

**Art. 45012-PVC**  
cm 60 x 80



# CURA DEL CORPO

## Spazzole e pettini

Cepillos y peines  
Brushes and combs  
Bürsten und Käämme  
Brosses et peignes

Design: Studio KOH-I-NOOR

# 1930



**Art. 980AV**  
cm 19 x 4



**Art. 973AV**  
cm 21,3 x 6



**Art. 971AV**  
cm 21,3 x 6



**Art. 980TR**  
cm 19 x 4



**Art. 973TR**  
cm 21,3 x 6



**Art. 971TR**  
cm 21,3 x 6



**Art. 980BL**  
cm 19 x 4



**Art. 973BL**  
cm 21,3 x 6



**Art. 971BL**  
cm 21,3 x 6

### Materiali

Acetato di cellulosa

### Materiales

Acetato celulósico

### Materials

Cellulose acetate

### Material

Zelluloseacetat

### Matériaux

Acétate de cellulose



# CURA DEL CORPO

## Spazzole e pettini

Cepillos y peines  
Brushes and combs  
Bürsten und Kämmen  
Brosses et peignes

Design: Studio KOH-I-NOOR

## Legno



Art. 689  
cm 21,3 x 6



Art. 683  
cm 21,3 x 6

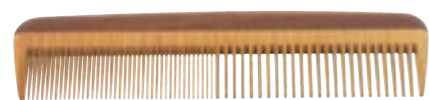

Art. 684  
cm 19 x 4



Art. 685  
cm 19, x 4,5



Art. 686  
cm 18 x 5

## Jaspè



Art. 109  
cm 21,3 x 6



Art. 206  
cm 21,3 x 6



Art. 612J  
cm 20 x 4



Art. 409J  
cm 18 x 4



Art. 457J  
cm 20,5 x 5

### Materiali

Jaspè: Acetato di cellulosa  
Legno: Acero americano

### Materiales

Jaspè: Acetato celulósico  
Legno: Acero americano

### Materials

Jaspè: Cellulose acetate  
Legno: American maple

### Material

Jaspè: Zelluloseacetat  
Legno: Amerikanischer Ahorn

### Matériaux

Jaspè: Acétate de cellulose  
Legno: Érable blanc



# CURA DEL CORPO

## Benessere

Cuidado del cuerpo  
Body care  
Körperpflege  
Soin du corps

Design: Studio KOH-I-NOOR



**Art. 5M**  
cm 8 - 9



**Art. 7M**  
cm 10 - 11



**Art. 9M**  
cm 12 - 13



**Art. 11M**  
cm 15 - 16



**Art. 13M**  
cm 18 - 19



**Art. OL1**



**Art. S5**  
cm 58/60 x 20



**Art. R12**



**Art. G4**



**Art. ML-PL3**

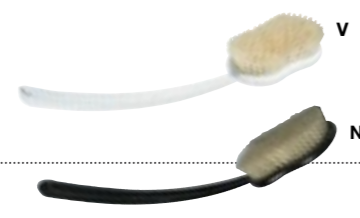

**Art. SC127V - SC127N**



**Art. SC130V - SC130N**

## Materiali

Fibra naturale Loofah  
Fibra naturale Sisal  
Spugne naturali mediterranee

## Materiales

Loofah  
Sisal  
Esponja natural

## Materials

Natural fiber Loofah  
Natural fiber Sisal  
Natural mediterranean sponges

## Material

Loofah  
Sisal  
Naturschwämme

## Matériaux

Loofah  
Sisal  
Éponges naturelles



# ACCESSORI A MURO E PIANTANE

Accesorios de pared y elementos de suelo | Wall accessories and equipped stands |  
Zubehör für Wandmontage und Mehrzweckständer | Accessoires à fixer et montants équipés

## APPLICAZIONE A TASSELLO

Montaje con taladro | Installation with  
plug | Anbringen mit Dübel | Installation  
à percer

Reka  
Fusion  
4Quattro  
6Sei  
Vitti  
Ska  
Practica

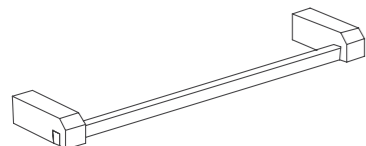

## APPLICAZIONE AD INCOLLO

Montaje con adhesivo | Adhesive  
System | Anbringung mit Klebeband |  
Installation à Coller

Lavi  
Materia  
10  
Tilda

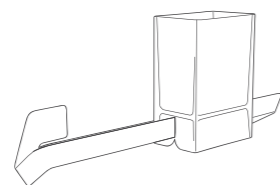

## APPLICAZIONE A TASSELLO E AD INCOLLO

Montaje con taladro y con adhesivo |  
Drilling and adhesive system |  
Anbringung mit Dübel und Klebeband |  
Installation à percer ou à coller

LeM 2.0  
LeM 2.T  
Tubina  
Tubina.T  
LaTonda  
LaTonda.T

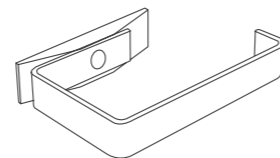

## GRIGLIE

Rejillas | Containers |  
Ablagekörbchen | Paniers

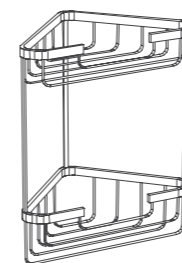

## MANIGLIONI

Manillones | Grab rails |  
Sicherheitswandgriffe | Poignés

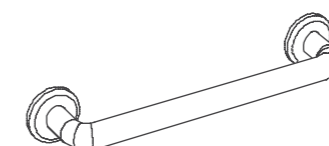

## PIANTANE

Elementos de suelo | Equipped stands |  
Mehrzweckständer | Montants équipés

Akka  
Koko

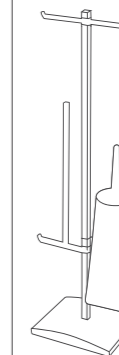



# LE SERIE

Accesorios de pared | Wall accessories | Zubehör für wandmontage | Accessoires à fixer



LAVÍ



MATERIA



10



TILDA



REKA



FUSION



4QUATTRO



6SEI



LEM 2.0



LEM 2.T



VITTI



TUBINA



TUBINA.T



PRACTICA



SKA



LATONDA



LATONDA.T

REKA



# REKA



## Serie di accessori a muro, applicazione a tassello

Accesorios de pared, se instala con taladro  
Set of wall accessories, installation with plug  
Zubehör für Wandmontage, Anbringen mit Dübel  
Accessoires à percer

Design: Pedrizzetti Associati & Studio KOH-I-NOOR



**Art. 6700 Appendino**  
Colgador | Hanger | Haken | Patère  
cm 5,5 x 7 x h 7



**Art. 6707/6704/6709 Portasalvietta**  
Toallero | Towel rack | Handtuchhalter | Porte-serviette  
cm 37/50/62 x 8 x h 5,5



**Art. 6706 Portasalvietta a snodo**  
Toallero giratorio | Turning towel rack | Schwenkbarer  
Handtuchhalter | Porte-serviette pivotant  
cm 36 x 5,5 x h 16



**Art. 6724 Portasalvietta / Portarotolo riserva**  
Toallero / Portarollos de reserva | Towel rack / Reserve paper  
holder | Handtuchhalter / Reserverollenhalter | Porte-serviette /  
Porte-rouleaux de réserve  
cm 24,5 x 8 x h 5,5



**Art. 6715+K630 Portasapone in policarbonato**  
Jabonera policarbonato | Soap holder - polycarbonate |  
Wandseifenschale-Polykarbonat | Porte-savon polycarbonate  
cm 13 x 9 x h 8,5



**Art. 6715+K638 Bicchiere in policarbonato**  
Portavasos policarbonato | Cup-polycarbonate | Wandbecher-  
Polykarbonat | Verre polycarbonate  
cm 10 x 9 x h 17



**Art. 6715+K657 Dispenser in policarbonato**  
Dosificador policarbonato | Soap dispenser-polycarbonate |  
Wandseifenspender-Polykarbonat | Doseur polycarbonate  
cm 10 x 9 x h 23,5



**Art. 6708 Portarotolo**  
Portarollos | Paper holder | Rollenhalter | Porte-rouleaux  
cm 16 x 8 x h 5,5



**Art. 6715+K930 Portasapone vetro acidato**  
Jabonera dcristal al ácido | Soap holder-acidified glass |  
Wandseifenschale-gesäuertes Kristallglas | Porte-savon cristal acidé  
cm 13 x 9 x h 9



**Art. 6715+K938 Bicchiere vetro acidato**  
Portavasos cristal al ácido | Cup acidified glass | Wandbecher-  
gesäuertes Kristallglas | Verre cristal acidé  
cm 10 x 9 x h 17



**Art. 6715+K957 Dispenser vetro acidato**  
Dosificador cristal al ácido | Soap dispenser-acidified glass |  
Wandseifenspender-gesäuertes Kristallglas | Doseur cristal acidé  
cm 10 x 9 x h 23,5



**Art. 6711 Scopino sospeso**  
Escobillero de pared | Wall toilet brush holder | Toilettenbürste  
Wandmodell | Porte-balai mural  
cm 9,5 x 9,5 x h 55

**Art. 6712 Scopino a terra**  
Escobillero de suelo | Toilet brush holder | Toilettenbürste | Porte-  
balai  
cm 9,5 x 9,5 x h 55

## FINITURE



KK

# FUSION



# FUSION



## Serie di accessori a muro, applicazione a tassello

Accesorios de pared, se instala con taladro  
Set of wall accessories, installation with plug  
Zubehör für Wandmontage, Anbringen mit Dübel  
Accessoires à percer

Design: Pedrizzetti Associati & Studio KOH-I-NOOR



**Art. 6600 Appendino**  
Coigador | Hanger | Haken | Patère  
cm 6,5 x 4 x h 5



**Art. 6607/6604/6609 Portasalviette**  
Toallero | Towel rack | Handtuchhalter | Porte-serviette  
cm 37/50/62 x 8 x h 4



**Art. 6606 Portasalviette a snodo**  
Toallero giratorio | Turning towel rack | Schwenkbarer Handtuchhalter | Porte-serviette pivotant  
cm 36 x 4 x h 16



**Art. 6624 Portasalviette / Portarotolo riserva**  
Toallero / Portarollos de reserva | Towel rack / Reserve paper holder | Handtuchhalter / Reserverollenhalter | Porte-serviette / Porte-rouleaux de réserve  
cm 24 x 8 x h 4



**Art. 6615+K630 Portasapone policarbonato**  
Jabonera policarbonato | Soap holder - polycarbonate | Wandseifenschale-Polykarbonat | Porte-savon polycarbonate  
cm 13 x 9 x h 7,5



**Art. 6615+K638 Bicchieri policarbonato**  
Portavasos policarbonato | Cup-polycarbonate | Wandbecher-Polykarbonat | Verre polycarbonate  
cm 10 x 9 x h 16



**Art. 6615+K657 Dispenser policarbonato**  
Dosificador policarbonato | Soap dispenser-polycarbonate | Wandseifenspender-Polykarbonat | Doseur polycarbonate  
cm 10 x 9 x h 22,5



**Art. 6608 Portarotolo**  
Portarollos | Paper holder | Rollenhalter | Porte-rouleaux  
cm 15 x 8 x h 4



**Art. 6615+K930 Portasapone vetro acidato**  
Jabonera cristal al ácido | Soap holder-acidified glass | Wandseifenschale-gesäuertes Kristallglas | Porte-savon cristal acidé.  
cm 13 x 9 x h 7,5



**Art. 6615+K938 Bicchieri vetro acidato**  
Portavasos cristal al ácido | Cup-acidified glass | Wandbecher-gesäuertes Kristallglas | Verre cristal acidé  
cm 10 x 9 x h 16



**Art. 6615+K957 Dispenser vetro acidato**  
Dosificador cristal al ácido | Soap dispenser acidified glass | Wandseifenspender-gesäuertes Kristallglas | Doseur cristal acidé  
cm 10 x 9 x h 22,5



**Art. 6611 Scopino sospeso**  
Escobillero de pared | Wall toilet brush holder | Toilettenbürste Wandmodell | Porte-balai mural  
cm 9,5 x 9,5 x h 55

**Art. 6612 Scopino a terra**  
Escobillero de suelo | Toilet brush holder | Toilettenbürste | Porte-balai  
cm 9,5 x 9,5 x h 55

## FINITURE



KK

# 4QUATTRO



# 4QUATTRO



## Serie di accessori a muro, applicazione a tassello

Accesorios de pared, se instala con taladro  
Set of wall accessories, installation with plug  
Zubehör für Wandmontage, Anbringen mit Dübel  
Accessoires à percer

Design: Studio KOH-I-NOOR



**Art. 7000 Appendino**  
Colgador | Hanger | Haken | Patère  
cm 1,5 x 4,5 x h 1,5



**Art. 7005/7006/7007 Portasalviette**  
Toallero | Towel rack | Handtuchhalter | Porte-serviette  
cm 32/48/60 x 7 x h 1,5



**Art. 7008 Portasalviette a snodo**  
Toallero giratorio | Turning towel rack | Schwenkbarer  
Handtuchhalter | Porte-serviette pivotant  
cm 32 x 1,5 x h 9



**Art. 7001 Portasapone vetro acidato**  
Jabonera cristal al ácido | Soap holder-acidified glass |  
Wandseifenschale-gesäuertes Kristallglas | Porte-savon cristal acidé.  
cm 13 x 12,5 x h 5,5



**Art. 7002 Bicchieri vetro acidato**  
Portavasos cristal al ácido | Cup-acidified glass | Wandbecher-  
gesäuertes Kristallglas | Verre cristal acidé  
cm 7 x 11,5 x h 12



**Art. 7014 Dispenser vetro acidato**  
Dosificador cristal al ácido | Soap dispenser acidified glass |  
Wandseifenspender-gesäuertes Kristallglas | Doseur cristal acidé  
cm 7,5 x 11,5 x h 20



**Art. 7009 Portarotolo**  
Portarrollos | Paper holder | Rollenhalter | Porte-rouleaux  
cm 16 x 7 x h 1,5

## FINITURE



KK

## Materiali

Ottone cromato. Bicchieri,  
portasapone, dosatore per  
sapone liquido: cristallo  
acidato. Scopino in ottone  
cromato  
Viteria: acciaio inox.

## Materiales

Estructura: latón cromado  
Vaso, jabonera, dosificador:  
cristal al ácido. Escobillero:  
latón cromado  
Tornillería: acero inoxidable.

## Materials

Chromed brass structure.  
Glass, soap dish and  
dispenser: acidified glass.  
Toilet brush holder: chromed  
brass. Fittings: stainless steel

## Material

Struktur: verchromtes  
Messing .  
Glas, Seifenschale, und  
Seifenspender : gesäuertes  
Kristallglas. Bürstengarniture:  
verchromtes Messing.  
Schrauben: Edelstahl

## Matériaux

Structure: laiton chromé.  
Verre, porte-savon et doseur:  
cristal dépoli. Porte- balai:  
laiton chromé.  
Visserie: acier inox.



**Art. 7011 Scopino sospeso**  
Escobillero de pared | Wall toilet brush holder | Toilettenbürste  
Wandmodell | Porte-balai mural  
ø cm 9 x h 38

**Art. 7012 Scopino a terra**  
Escobillero de suelo | Toilet brush holder | Toilettenbürste | Porte-  
balai  
ø cm 9 x h 38

# 6SEI





# 6SEI



## Serie di accessori a muro, applicazione a tassello

Accesorios de pared, se instala con taladro  
Set of wall accessories, installation with plug  
Zubehör für Wandmontage, Anbringen mit Dübel  
Accessoires à percer

Design: Studio KOH-I-NOOR



**Art. 7300 Appendino**  
Colgador | Hanger | Haken | Patère  
cm 1,5 x 4,5 x h 3,5



**Art. 7305/7306/7307 Portasalviette**  
Toallero | Towel rack | Handtuchhalter | Porte-serviette  
cm 32/48/60 x 7 x h 1,5



**Art. 7308 Portasalviette**  
Toallero | Towel rack | Handtuchhalter | Porte-serviette  
cm 36 x 9 x h 1,5



**Art. 7301 Portasapone vetro acidato**  
Jabonera cristal al ácido | Soap holder-acidified glass |  
Wandseifenschale-gesäuertes Kristallglas | Porte-savon cristal acidé.  
cm 13 x 12,5 x h 5,5



**Art. 7302 Bicchiere vetro acidato**  
Portavasos cristal al ácido | Cup-acidified glass | Wandbecher-  
gesäuertes Kristallglas | Verre cristal acidé  
cm 7 x 11,5 x h 12



**Art. 7314 Dispenser vetro acidato**  
Dosificador cristal al ácido | Soap dispenser acidified glass |  
Wandseifenspender-gesäuertes Kristallglas | Doseur cristal acidé  
cm 7,5 x 11,5 x h 20



**Art. 7309 Portarotolo**  
Portarrollos | Paper holder | Rollenhalter | Porte-rouleaux  
cm 16 x 7 x h 1,5

## FINITURE



KK

## Materiali

Ottone cromato. Bicchieri,  
portasapone, dosatore per  
sapone liquido: cristallo  
acidato. Scopino in ottone  
cromato  
Viteria: acciaio inox.

## Materiales

Estructura: latón cromado  
Vaso, jabonera, dosificador:  
cristal al ácido. Escobillero:  
latón cromado  
Tornillería: acero inoxidable.

## Materials

Chromed brass structure.  
Glass, soap dish and  
dispenser: acidified glass.  
Toilet brush holder: chromed  
brass. Fittings: stainless steel

## Material

Struktur: verchromtes  
Messing.  
Glas, Seifenschale, und  
Seifenspender : gesäuertes  
Kristallglas. Bürstengarniture:  
verchromtes Messing.  
Schrauben: Edelstahl

## Matériaux

Structure: laiton chromé.  
Verre, porte-savon et doseur:  
cristal dépoli. Porte- balai:  
laiton chromé.  
Visserie: acier inox.



**Art. 7311 Scopino sospeso**  
Escobillero de pared | Wall toilet brush holder | Toilettenbürste  
Wandmodell | Porte-balai mural  
ø cm 9 x h 38

**Art. 7312 Scopino a terra**  
Escobillero de suelo | Toilet brush holder | Toilettenbürste | Porte-  
balai  
ø cm 9 x h 38

VITTI



# VITTI



## Serie di accessori a muro, applicazione a tassello

Accesorios de pared, se instala con taladro  
Set of wall accessories, installation with plug  
Zubehör für Wandmontage, Anbringen mit Dübel  
Accessoires à percer

Design: Studio KOH-I-NOOR



### Art. 5400 Appendino (2 pezzi)

Colgador 2pz | Hanger 2pz | Haken 2st | Patère 2p  
ø cm 3 x 4,5



### Art. 5419/5404/5405 Portasalviette

Toallero | Towel rack | Handtuchhalter | Porte-serviette  
cm 33/43/60 x 8 x h 3



### Art. 5406 Portasalviette a snodo

Toallero giratorio | Turning towel rack | Schwenkbarer Handtuchhalter | Porte-serviette pivotant  
cm 35 x 8 x h 11



### Art. 5417 Portasapone da parete policarbonato

Jabonera de pared-policarbonato | Wall soap holder - polycarbonate | Wandseifenschale-Polykarbonat | Porte-savon mural-polycarbonate  
cm 13 x 12 x h 6



### Art. 5418 Bicchiere da parete policarbonato

Portavasos de pared-policarbonato | Wall cup-polycarbonate | Wandbecher-Polykarbonat | Verre mural-polycarbonate  
cm 7 x 11 x h 14



### Art. 5416 Dispenser da parete policarbonato

Dosificador de pared-policarbonato | Wall soap dispenser-polycarbonate | Wandseifenspender-Polykarbonat | Doseur mural-polycarbonate  
cm 7,5 x 11 x h 19



### Art. 5420 Portarotolo

Portarrollos | Paper holder | Rollenhalter | Porte-rouleaux  
cm 19 x 8 x h 3

## Materiali

Aste in ottone cromato.  
Supporto in ABS cromato.  
Bicchieri, portasapone, dosatore per sapone liquido: policarbonato.  
Scopino: ABS cromato.

## Materiales

Barras: latón cromado.  
Soporte: ABS cromado.  
Vaso, jabonera, dosificador: policarbonato.  
Escobillero: ABS cromado.

## Materials

Bars: chromed brass.  
Support: chromed ABS.  
Glass, soap holder, soap dispenser: polycarbonate.  
Toilet brush: chromed ABS.

## Material

Stangen: verchromtes Messing  
Halterungen: verchromtes ABS.  
Glas, Seifenhälter, Seifenspender: Polykarbonat.  
Toilettenbürste: verchromtes ABS.

## Matériaux

Tiges: laiton chromé.  
Support: ABS chromé  
Verre, porte-savon, doseur de savon liquide: polycarbonate.  
Porte-balai: ABS chromé.



### Art. 5413 Scopino sospeso

Escobillero de pared | Wall toilet brush holder | Toilettenbürste Wandmodell | Porte-balai mural  
ø cm 9 x h 38

### Art. 5414 Scopino a terra

Escobillero de suelo | Toilet brush holder | Toilettenbürste | Porte-balai  
ø cm 9 x h 38

## FINITURE



KK



# SKA

## Serie di accessori a muro, applicazione a tassello

Accesorios de pared, se instala con taladro  
Set of wall accessories, installation with plug  
Zubehör für Wandmontage, Anbringen mit Dübel  
Accessoires à percer



N I T O

Design: Itamar Harari



**Art. 6815000 Appendino**

Colgador | Hanger  
Haken | Patère  
cm 6 x 7,3 x h 2,3



**Art. 6810011/6810013/6810014 Portasalviette**

Toallero | Towel rack  
Handtuchhalter | Porte-serviette  
cm 30/45/60 x 7,5 x h 1,8



**Art. 6803014 Mensola cristallo**

Estante cristal transparente | Flat shelf transparent glass |  
Abstellplatte transparentes Kristallglas | Tablette cristal transparent  
cm 50 x 14 x h 1,8



**Art. 6805000 Portasapone cristallo14 trasparente**

Jabonera de pared cristal transparente | Wall soap holder  
transparent glass | Wandseifenschale transparentes Kristallglas |  
Porte-savon mural cristal transparent  
cm 16 x 14 x h 1,8



**Art. 6806000 Bicchiere cristallo trasparente**

Portavasos de pared cristal transparente | Wall cup transparent  
glass | Wandbecher-transparentes Kristallglas | Verre mural cristal  
transparent  
cm 16 x 14 x h 10,5



**Art. 6807000 Bicchiere doppio cristallo trasparente**

Portavasos double cristal transparente | Double glass transparent  
glass | Doppeltes Wandglas transparentes Kristallglas | Double  
verre mural cristal transparent  
cm 25,4 x 14 x h 10,5



**Art. 6812000 Portarotolo**

Portarrollis | Paper holder | Rollenhalter | Porte-rouleaux  
cm 16 x 14 x h 1,8

### Materiali

Struttura: ottone cromato.  
Bicchiere, portasapone e  
scopino: cristallo trasparente.  
Manico scopino in plexiglass.  
Viteria: acciaio inox.

### Materiales

Estructura: latón cromado.  
Vaso, jabonera y escobillero:  
cristal. Palo escobillero en  
plexiglass.  
Tornillería: acero inoxidable.

### Materials

Chromed brass structure.  
Glass, soap dish and toilet  
brush: transparent glass.  
Toilet brush handle of  
plexiglass. Fittings: stainless  
steel

### Material

Struktur: verchromtes  
Messing. Glas, Seifenschale  
und Toilettenbürste:  
Kristallglas. Toilettenbürsten  
griff: Plexiglas. Schrauben:  
Edelstahl

### Matériaux

Structure: laiton chromé.  
Verre, porte-savon et porte-  
balai: cristal. Manche porte-  
balai : plexiglass  
Visserie: acier inox.



**Art. 6813000 Scopino sospeso cristallo trasparente**

Escobillero de pared cristal transparente | Wall toilet brush holder  
transparent glass | Toilettenbürste Wandmodell transparentes Kristallglas |  
Porte-balai mural cristal transparent  
cm 16,5 x 14 x h 32,5

## FINITURE



KK

# PRACTICA



# PRACTICA



## Serie di accessori a muro, applicazione a tassello

Accesorios de pared, se instala con taladro  
Set of wall accessories, installation with plug  
Zubehör für Wandmontage, Anbringen mit Dübel  
Accessoires à percer

N I T O

Design: Studio NITO



**Art. 6915061 Appendino**  
**Art. 6915000 Appendino**  
Colgador | Hanger | Haken | Patère  
cm 8 x 8 x h 2,7



**Art. 6911161 / 6911361 / 6911461 Portasalvietta**  
**Art. 6911100 / 6911300 / 6911400 Portasalvietta**  
Toallero | Towel rack | Handtuchhalter | Porte-serviette  
cm 30/45/60 x 8 x h 1,4

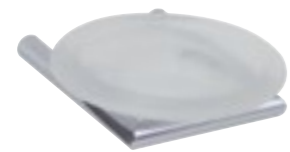

**Art. 6905061 Portasapone da parete vetro acidato**  
**Art. 6905000 Portasapone da parete vetro acidato**  
Jabonera de cristal al ácido | Soap holder-acidified glass |  
Wandseifenschale-gesäuertes Kristallglas | Porte-savon cristal acidé  
cm 12,5 x 12 x h 3



**Art. 6906061 Bicchiere da parete vetro acidato**  
**Art. 6906000 Bicchiere da parete vetro acidato**  
Portavasos cristal al ácido | Cup acidified glass | Wandbecher-  
gesäuertes Kristallglas | Verre cristal acidé  
cm 9,5 x 12 x h 10



**Art. 6912061 Portarotolo**  
**Art. 6912000 Portarotolo**  
Portarollos | Paper holder | Rollenhalter | Porte-rouleaux  
cm 14 x 10,5 x h 8,5



**Art. 6913061 Scopino sospeso vetro acidato**  
**Art. 6913000 Scopino sospeso vetro acidato**  
Escobillero de pared cristal al ácido | Wall toilet brush holder  
acidified glass | Toilettenbürste Wandmodell gesäuertes Kristallglas |  
Porte-balai mural cristal acidé  
cm 12 x 12 x h 28

## Materiali

Struttura: acciaio inox  
cromato o satinato.  
Bicchieri, portasapone e  
scopino: cristallo acidato.  
Viteria: acciaio inox.

## Materiales

Estructura: acero inoxidable  
cromado o afectado. Vaso,  
jabonera y escobillero: cristal  
al ácido.  
Tornillería: acero inoxidable.

## Materials

Chromed or brushed  
stainless steel structure.  
Glass ,soap dish and toilet  
brush: acidified glass.  
Fittings: stainless steel

## Material

Struktur: verchromter oder  
gebürsteter Edelstahl.  
Glas, Toilettenbürste und  
Seifenschale: gesäuertes  
Kristallglas.  
Schrauben: Edelstahl

## Matériaux

Structure: acier inoxydable  
chromé ou brossé. Verre,  
porte-savon et porte balai:  
cristal acidé.  
Visserie: acier inox.



## FINITURE

**Art. ----061 Acciaio inox cromato**  
Acero inoxidable cromado | Chromed stainless steel |  
Verchromter Edelstahl | Acier inoxydable chromé

**Art. ----000 Acciaio inox satinato**  
Acero inoxidable afectado | Brushed stainless steel |  
Gebürsteter Edelstahl | Acier inoxydable brossé

## FINITURE

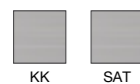

KK

SAT

# ISTRUZIONI

Instructions | Instructions | Instructions | Instructions

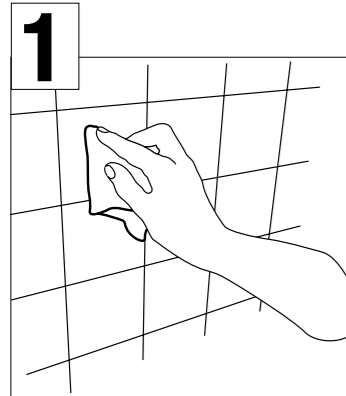

**1**  
Pulire la superficie di appoggio con una soluzione di acqua e alcool al 50%

Limpiar la superficie de apoyo con una solución de agua y alcohol al 50%

Clean the surface for mounting with a solution of water and alcohol (50%V/V)

Die Anbringfläche mit einer Lösung aus 50% Wasser und 50% Alkohol reinigen

Nettoyez la surface d'appui avec une solution d'alcool et d'eau (diluer au 50%)

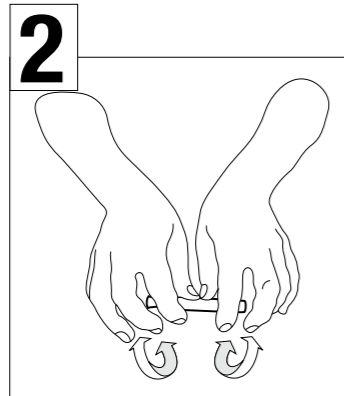

**2**  
Spezzare la capsula di primer e premere fino a che il pennellino non si imbeve di liquido

Apretar el "primer" para romper la cápsula interna hasta que el líquido moje el tampón

Break the inner capsule of the primer and press until the brush is soaked

Die Kapsel mit der Grundierung aufbrechen und so lange drücken, bis der Pinsel mit Flüssigkeit getränkt ist

Cassez la capsule à l'intérieur du primer jusqu'à ce que le tampon soit imprégné

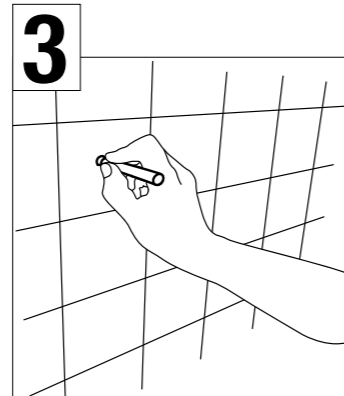

**3**  
Passare un sottile strato di primer sulla parete per aumentarne l'adesività e LASCIARE ASCIUGARE PER 5 MINUTI

Aplicar una fina capa de "primer" sobre la pared para aumentar la adherencia y DEJAR SECAR 5 MINUTOS

Apply a thin layer of primer on the wall to increase the adhesiveness and LET IT DRY FOR 5 MINUTES

Eine dünne Schicht Grundierung auf die Wand auftragen um die Haftung zu verbessern und 5 MINUTEN TROCKNEN LASSEN

Appliquez une couche fine de primer sur le mur pour augmenter l'adhésivité et LAISSEZ QUE LE LIQUIDE SÈCHE POUR 5 MINUTES

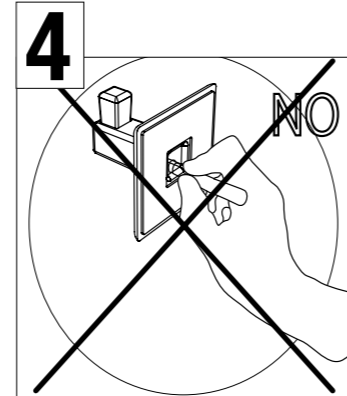

**4**  
**IMPORTANTE!!**  
NON PASSARE IL PRIMER SULL'ADESIVO!

IMPORTANTE!!  
NO USAR EL "PRIMER" SOBRE EL ADHESIVO!

IMPORTANT!!  
DON'T USE THE PRIMER ON THE ADHESIVE!

WICHTIG!!  
DIE GRUNDIERUNG NICHT AUF DAS KLEBEBAND AUFTRAGEN!

IMPORTANT!!  
NE PAS APPLIQUER LE PRIMER SUR L'ADHESIF!

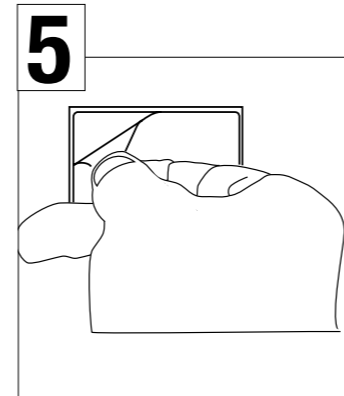

**5**  
Togliere la pellicola dall'adesivo.  
Non toccarlo con le dita

Retirar la protección del adhesivo. No tocarlo con los dedos

Remove the protection from the adhesive. Don't touch it with your fingers

Das Schutzpapier vom Klebeband abziehen, nicht mit den Fingern berühren

Enlevez la protection de l'adhésif. Ne pas le toucher avec les doigts



**6**  
Applicare al muro partendo dallo spigolo inferiore

Colocar sobre la pared comenzando desde el borde inferior

Place the support on the wall starting from the bottom edge

Mit der unteren Kante zuerst an der Wand anbringen

Appliquez le support au mur en partant du bord inférieur

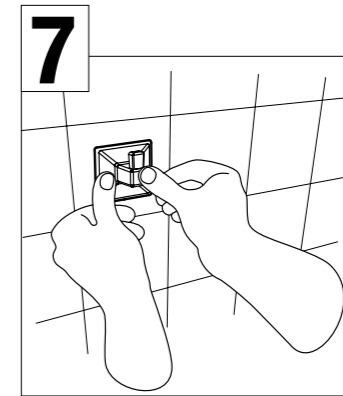

**7**  
**IMPORTANTE!!**  
Premere con molta forza per qualche secondo sull'oggetto.  
**NON CARICARE PESI PER 24H**

IMPORTANTE!!  
Presionar fuertemente durante unos segundos sobre el objeto.  
NO CARGAR PESOS ANTES DE 24 HORAS

IMPORTANT!!  
Press strongly for some seconds on the object.  
DON'T PUT ANY WEIGHT FOR 24 HOURS

WICHTIG!!  
Die Halterung einige Sekunden lang kräftig andrücken.  
24 STUNDEN LANG NICHT BELASTEN

IMPORTANT!!  
Pressez fort sur l'article pour quelque seconde.  
NE PAS CHARGER DU POIDS POUR 24 HEURES





LAVÍ





## Serie di accessori a muro, applicazione con adesivo 3M

Accesorios de pared, se instala con adhesivo 3M  
Set of wall accessories, installation with adhesive 3M  
Zubehör für Wandmontage, Anbringen mit 3M Klebeband  
Accessoires à coller, s'applique avec adhésif 3M

Design: Studio KOH-I-NOOR e Monica Cerina



**Art. 5900 Appendino**  
Colgador | Hanger | Haken | Patère  
cm 5,4 x 4 x h 6,3



**Art. 5916 Appendino doppio**  
Colgador doble | Double hanger | Doppelter Haken | Patère double  
cm 10,5 x 4 x h 6,3



**Art. 5907/5904/5909 Portasalvietta**  
Toallero | Towel rack | Handtuchhalter | Porte-serviette  
cm 35/45/60 x 6 x h 6,5



**Art. 5906 Portasalvietta a snodo**  
Toallero giratorio | Turning towel rack | Schwenkbarer Handtuchhalter | Porte-serviette pivotant  
cm 32 x 11 x h 5



**Art. 5920 Cestino contenitore**  
Contenedor | Container | Ablage | Panier  
cm 27 x 19 x h 8



**Art. 5919 Cestino contenitore**  
Contenedor | Container | Ablage | Panier  
cm 25 x 10 x h 8



**Art. 5921 Cestino contenitore**  
Contenedor | Container | Ablage | Panier  
cm 35 x 10 x h 8



**Art. 5908 Portarotolo / supporto per accessori**  
Portarollos | Soporte para accesorios | Paper holder / Support for accessories | Rollenhalter / Halterung für Accessoires | Porte-rouleaux / Support pour accessoires  
cm 14 x 6 x h 6,5



**Art. K830 Portasapone da parete in policarbonato**  
Jabonera de pared-policarbonato | Wall soap holder - polycarbonate | Wandseifenschale-Polykarbonat | Porte-savon mural-polycarbonate  
cm 9 x 14,5 x h 4,5



**Art. K838 Bicchiera da parete in policarbonato**  
Portavasos de pared-policarbonato | Wall cup-polycarbonate | Wandbecher-Polykarbonat | Verre mural-polycarbonate | Doseur mural-cristal acide  
cm 8,5 x 5,5 x h 12



**Art. K857 Dispenser da parete in policarbonato**  
Dosificador de pared-policarbonato | Wall soap dispenser-polycarbonate | Wandseifenspender-Polykarbonat | Doseur mural-polycarbonate  
cm 8,5 x 5,5 x h 16,5



**Art. 5924 Portasalvietta**  
Toallero | Towel rack | Handtuchhalter | Porte-serviette  
cm 23,3 x 6 x h 6,5



**Art. 5911 Scopino sospeso**  
Escobillero de pared | Wall toilet brush holder | Toilettenbürste Wandmodell | Porte-balai mural  
cm 9,5 x 9,5 x h 55

**Art. 5912 Scopino a terra**  
Escobillero de suelo | Toilet brush holder | Toilettenbürste | Porte-balai  
cm 9,5 x 9,5 x h 55

## FINITURE



KK

### Bicchiera, portasapone, dosatore

Vaso, jabonera y dosificador | Glass, soap holder and soap dispenser  
Glas, Seifenhalter, Seifenspender | Verre, porte-savon, doseur de savon

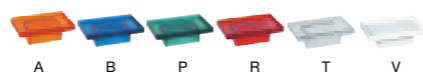

A B P R T V

# MATERIA



# MATERIA



## Serie di accessori a muro, applicazione con adesivo 3M

Accesorios de pared, se instala con adhesivo 3M  
Set of wall accessories, installation with adhesive 3M  
Zubehör für Wandmontage, Anbringen mit 3M Klebeband  
Accessoires à coller, s'applique avec adhésif 3M

Design: Studio KOH-I-NOOR



**Art. 6000 Appendino**  
Colgador | Hanger | Haken | Patère  
cm 3 x 4,6 x h 8



**Art. 6001 Gancio portasalviette**  
Toallero aro | Towel rack | Handtuchhalter | Porte-serviette  
cm 11,6 x 3 x h 11,8



**Art. 6007/6004/6009 Portasalviette**  
Toallero | Towel rack | Handtuchhalter | Porte-serviette  
cm 32/45/60 x 7,6 x h 3



**Art. 6008 Portarotolo**  
Portarrollos | Paper holder | Rollenhalter | Porte-rouleaux  
cm 14,8 x 7,6 x h 3



**Art. 6006 Portasalviette a snodo**  
Toallero giratorio | Turning towel rack | Schwenkbarer Handtuchhalter | Porte-serviette pivotant  
cm 31 x 3 x h 11

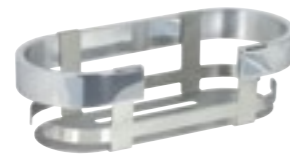

**Art. 6019 Cestino contenitore**  
Contenedor | Container | Ablage | Panier  
cm 27 x 11,6 x h 8



**Art. 6024 Portasalviette**  
Toallero | Towel rack | Handtuchhalter | Porte-serviette  
cm 22,8 x 7,6 x h 3



**Art. 6010 Portarotolo chiuso**  
Portarrollos con tapa | Paper holder | Rollenhalter | Porte-rouleaux  
cm 14,8 x 15 x h 9



**Art. 6017 Portasapone policarboanto**  
Jabonera policarbonato | Soap holder polycarbonate | Wandseifenschale-Polykarbonat | Porte-savon polycarbonate  
cm 11,5 x 13 x h 7,5



**Art. 6018 Bicchieri policarboanto**  
Portavasos policarbonato | Cup polycarbonate | Wandbecher-Polykarbonat | Verre polycarbonate  
cm 10 x 8 x h 11



**Art. 6014 Dispenser policarboanto**  
Dosificador policarbonato | Soap dispenser polycarbonate | Wandseifenspender-Polykarbonat | Doseur polycarbonate  
cm 10 x 8 x h 18



**Art. 6011 Scopino sospeso**  
Escobillero de pared | Wall toilet brush holder | Toilettenbürste Wandmodell | Porte-balai mural  
cm 9,5 x 9,5 x h 53

**Art. 6012 Scopino a terra**  
Escobillero de suelo | Toilet brush holder | Toilettenbürste | Porte-balai  
cm 9,5 x 9,5 x h 53

## FINITURE



KK



# 10

## Serie di accessori a muro, applicazione con adesivo 3M

Accesorios de pared, se instala con adhesivo 3M  
Set of wall accessories, installation with adhesive 3M  
Zubehör für Wandmontage, Anbringen mit 3M Klebeband  
Accessoires à coller, s'applique avec adhésif 3M



### Art. 6113 x3 - 6113 x6 Specchio monofacciale a parete snodato con adesivo

Espejo de una cara de pared articulado con adhesivo.  
Supple single face mirror with adhesive.  
Beweglicher Einseitige Spiegel mit Klebesystem.  
Miroir une face articulé autocollant.

ø cm 23 x h 10

Design: Studio KOH-I-NOOR



### Art. 6100 Appendino

Colgador | Hanger | Haken | Patère  
ø cm 7,5 x 5



### Art. 6116 Appendino doppio

Colgador doble | Double hanger | Doppelter Haken | Patère double  
ø cm 7,5 x 6



### Art. 6107/6104/6109 Portasalviette

Toallero | Towel rack | Handtuchhalter | Porte-serviette  
cm 39/56/66 x 6 x h 7,5



### Art. 6106 Portasalviette a snodo

Toallero giratorio | Turning towel rack | Schwenkbarer Handtuchhalter | Porte-serviette pivotant  
cm 34 x 7,5 x h 7,5



### Art. 6124 Portasalviette

Toallero | Towel rack | Handtuchhalter | Porte-serviette  
cm 22 x 6 x h 14



### Art. 6108 Portarotolo

Portarrotolos | Paper holder | Rollenhalter | Porte-rouleaux  
cm 13,5 x 6 x h 10



### Art. 6117 Portasapone policarbonato

Jabonera policarbonato | Soap holder polycarbonate | Wandseifenschale-Polykarbonat | Porte-savon polycarbonate  
cm 13 x 9,5 x h 7,5



### Art. 6118 Bicchieri policarbonato

Portavasos policarbonato | Cup polycarbonate | Wandbecher-Polykarbonat | Verre polycarbonate  
cm 7,5 x 9 x h 15



### Art. 6114 Dispenser policarbonato

Dosificador policarbonato | Soap dispenser polycarbonate | Wandseifenspender-Polykarbonat | Doseur polycarbonate  
cm 7,5 x 9 x h 20



### Art. 6119 Cestino contenitore policarbonato

Contenedor policarbonato | Container polycarbonate | Ablage Polykarbonat | Panier polycarbonate  
cm 28 x 11,5 x h 7,5



### Art. 6198 x 2 +45811 Mensola portasalviette

Toallero estante | Towel shelf | Handtuchablage | Étagère porte-serviettes  
cm 50 x 29 x h 20



### Art. 6112 Scopino a terra

Escobillero de suelo | Toilet brush holder | Toilettenbürste | Porte-balai  
cm 9 x 9 x h 38



### Art. 6198+45807/45808 Cestino contenitore

Contenedor | Container | Ablage | Panier  
cm 35/45 x 12 x h 8/11,7



### Art. 6198+45809 Cestino contenitore

Contenedor | Container | Ablage | Panier  
cm 23,3 x 10,3 x h 8/11,7



### Art. 6198+45802 Cestino contenitore

Contenedor | Container | Ablage | Panier  
cm 23,3 x 10,3 x h 5/8,7



### Art. 6198+45806 Cestino contenitore

Contenedor | Container | Ablage | Panier  
cm 19 x 19 x h 8/11,7



### Art. 6198+45803 Cestino contenitore

Contenedor | Container | Ablage | Panier  
cm 19 x 19 x h 31/34,7

### Art. 6111 Scopino sospeso

Escobillero de pared | Wall toilet brush holder | Toilettenbürste Wandmodell | Porte-balai mural  
cm 9 x 9 x h 38

## FINITURE



KK

# TILDA



# TILDA



## Serie di accessori a muro, applicazione con adesivo 3M

Accesorios de pared, se instala con adhesivo 3M  
Set of wall accessories, installation with adhesive 3M  
Zubehör für Wandmontage, Anbringen mit 3M Klebeband  
Accessoires à coller, s'applique avec adhésif 3M

Design: Studio KOH-I-NOOR



**Art. 5700 Appendino (2 pezzi)**  
Colgador 2pz | Hanger 2pz | Haken 2st | Patère 2p  
cm 5,5 x 4,5 x h 5,5



**Art. 5707/5704 Portasalviette**  
Toallero | Towel rack | Handtuchhalter | Porte-serviette  
cm 36/52 x 7 x h 5,5



**Art. 5710 Portasalviette / Portarotolo riserva**  
Toallero / Portarrollos de reserva | Towel rack / Reserve paper holder | Handtuchhalter / Reserverollenhalter | Porte-serviette / Porte-rouleaux de réserve  
cm 25,5 x 7 x h 5,5



**Art. 5706 Portasalviette a snodo**  
Toallero giratorio | Turning towel rack | Schwenkbarer Handtuchhalter | Porte-serviette pivotant  
cm 33 x 5,5 x h 12



**Art. 5724 Portasalviette**  
Toallero | Towel rack | Handtuchhalter | Porte-serviette  
cm 22,5 x 7 x h 13,5



**Art. 5708 Portarotolo**  
Portarrollos | Paper holder | Rollenhalter | Porte-rouleaux  
cm 16 x 7 x h 5,5



**Art. 5717 Portasapone policarbonato**  
Jabonera policarbonato | Soap holder - polycarbonate | Wandseifenschale-Polykarbonat | Porte-savon polycarbonate  
cm 13 x 10,5 x h 5,5



**Art. 5718 Bicchieri policarbonato**  
Portavasos policarbonato | Cup-polycarbonate | Wandbecher-Polykarbonat | Verre polycarbonate  
cm 8 x 9,5 x h 13,5



**Art. 5714 Dispenser policarbonato**  
Dosificador policarbonato | Soap dispenser-polycarbonate | Wandseifenspender-Polykarbonat | Doseur polycarbonate  
cm 8 x 9,5 x h 20

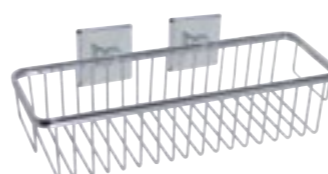

**Art. 5798+45807 Cestino contenitore**  
Contenedor | Container | Ablage | Panier  
cm 35 x 12 x h 8/11,7

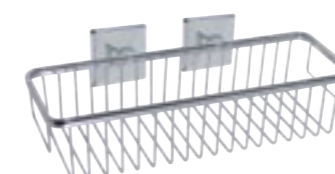

**Art. 5798+45808 Cestino contenitore**  
Contenedor | Container | Ablage | Panier  
cm 45 x 12 x h 8/11,7

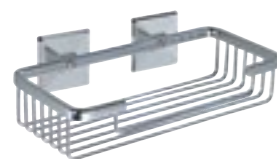

**Art. 5719 Cestino contenitore**  
Contenedor | Container | Ablage | Panier  
cm 23,3 x 12 x h 7,5/5



**Art. 5798+45806 Cestino contenitore**  
Contenedor | Container | Ablage | Panier  
cm 19 x 19 x h 8/11,7



**Art. 5798+45803 Cestino contenitore**  
Contenedor | Container | Ablage | Panier  
cm 19 x 19 x h 31/34,7



**Art. 5798+45809 Cestino contenitore**  
Contenedor | Container | Ablage | Panier  
cm 23,3 x 10,3 x h 8/11,7



**Art. 5798 x 2 + 45811 Mensola portasalviette**  
Toallero estante | Towel shelf | Handtuchablage | Étagère porte-serviettes  
cm 50 x 29 x h 20



**Art. 5711 Scopino sospeso**  
Escobillero de pared | Wall toilet brush holder | Toilettenbürste Wandmodell | Porte-balai mural  
cm 10 x 10 x h 36

## FINITURE



KK

Solo appendini  
Colgadores solo | Hangers only | Nur Haken | Patères seulement



B

A

R

P

KK

V



# LEM 2.0 LEM 2.T

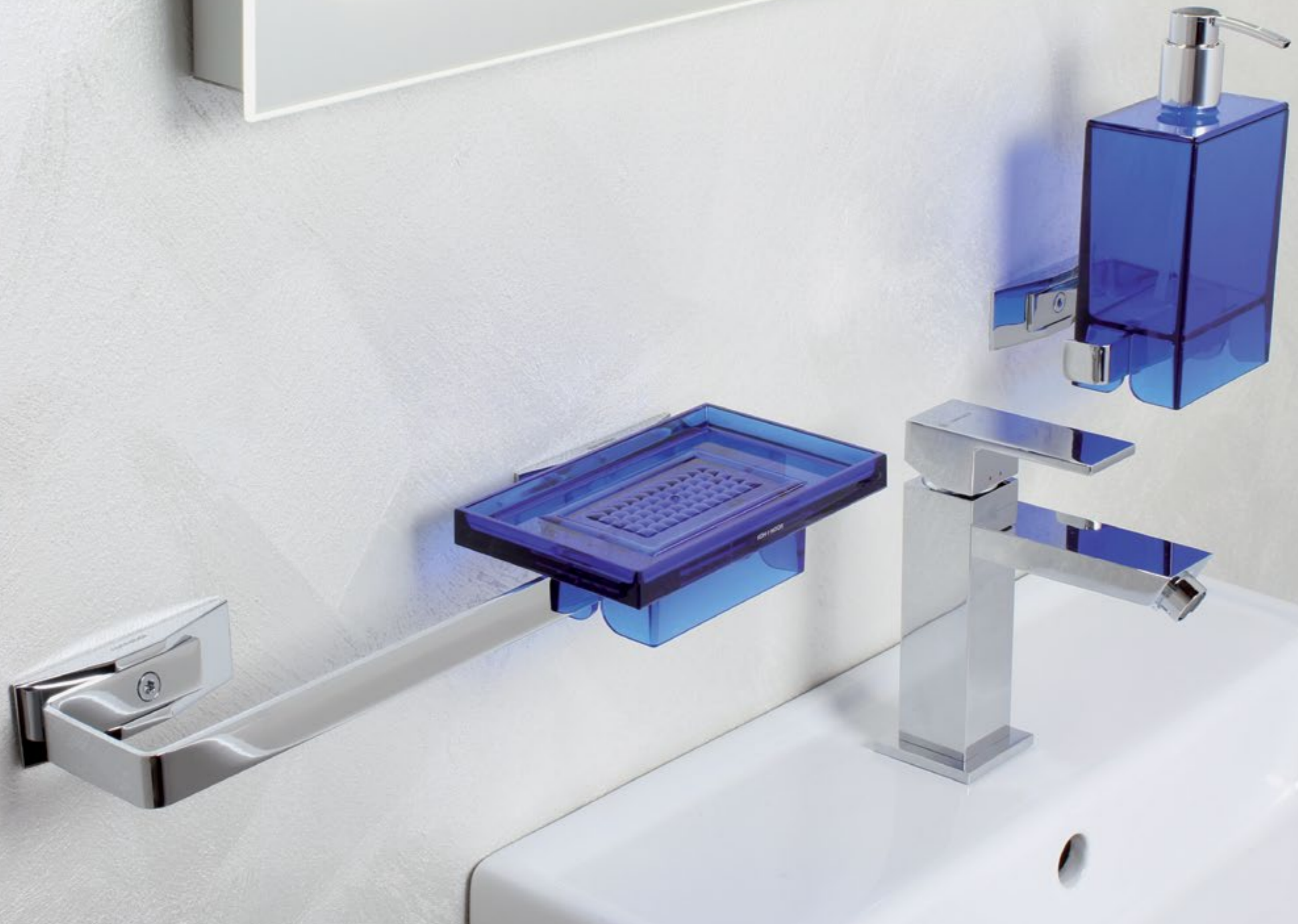

# LEM 2.0



## Serie di accessori a muro, applicazione con adesivo 3M

Accesorios de pared, se instala con adhesivo 3M  
Set of wall accessories, installation with adhesive 3M  
Zubehör für Wandmontage, Anbringen mit 3M Klebeband  
Accessoires à coller, s'applique avec adhésif 3M

Design: Studio KOH-I-NOOR e Monica Cerina



**Art. 6200 Appendino**  
Colgador | Hanger | Haken | Patère  
cm 8,5 x 3 x h3



**Art. 6216 Appendino doppio**  
Colgador doble | Double hanger | Doppelter Haken | Patère double  
cm 8,5 x 5 x h3



**Art. 6207/6204/6209 Portasalviette**  
Toallero | Towel rack | Handtuchhalter | Porte-serviette  
cm 32/45/60 x 6,5 x h 3



**Art. 6206 Portasalviette a snodo**  
Toallero giratorio | Turning towel rack | Schwenkbarer Handtuchhalter | Porte-serviette pivotant  
cm 30 x 9 x h 11



**Art. 6208 Portarotolo / supporto per accessori**  
Portarollos / Soporte para accesorios | Paper holder / Support for accessories | Rollenhalter / Halterung für Accessoires | Porte-rouleaux / Support pour accessoires  
cm 11,3 x 7,5 x h 3



**Art. 6224 Portasalviette / Portarotolo riserva**  
Toallero / Portarollos de reserva | Towel rack / Reserve paper holder | Handtuchhalter / Reserverollenhalter | Porte-serviette / Porte-rouleaux de réserve  
cm 22 x 7,5 x h 3



**Art. K830 Portasapone da parete in policarbonato**  
Jabonera de pared-policarbonato | Wall soap holder - polycarbonate | Wandseifenschale-Polykarbonat | Porte-savon mural-polycarbonate  
cm 14,5 x 9 x h 4,5



**Art. K838 Bicchieri da parete in policarbonato**  
Portavasos de pared-policarbonato | Wall cup-polycarbonate | Wandbecher-Polykarbonat | Verre mural-polycarbonate | Doseur mural-cristal acide  
cm 8,5 x 5,5 x h 12



**Art. K857 Dispenser da parete in policarbonato**  
Dosificador de pared-policarbonato | Wall soap dispenser-polycarbonate | Wandseifenspender-Polykarbonat | Doseur mural-polycarbonate  
cm 8,5 x 5,5 x h 16,5

## Materiali

Aste: acciaio inox cromato.  
Griglie: ottone cromato.  
Supporti: alluminio cromato.  
Bicchiere, portasapone, dosatore per sapone liquido, scopino: policarbonato e ABS.

## Materiales

Barras: acero inoxidable cromado. Rejillas: latón cromado. Soportes: aluminio cromado.  
Vaso, jabonera y dosificador, escobillero: policarbonato y ABS.

## Materials

Bars: Chromed stainless steel. Grids: chromed brass. Supports: chromed aluminium.  
Glass, soap holder and soap dispenser. Toilet brush holder: polycarbonate and ABS.

## Material

Stangen: verchromter Edelstahl. Ablagen: verchromtes Messing. Halterungen: verchromtes Aluminium.  
Glas, Seifenhalter, Seifenspender, Bürstengaritur: Polykarbonat, ABS.

## Matériaux

Tiges: acier inox chromé. Paniers: laiton chromé. Supports: aluminium chromé. Verre, porte-savon, doseur de savon liquide, porte-balai : polycarbonate et ABS.



**Art. 6220 Cestino contenitore**  
Contenedor | Container | Ablage | Panier  
cm 19 x 19 x h 8



**Art. 6219 Cestino contenitore**  
Contenedor | Container | Ablage | Panier  
cm 23,3 x 10,3 x h 8



**Art. 6221 Cestino contenitore**  
Contenedor | Container | Ablage | Panier  
cm 19 x 19 x h 31



**Art. 6211 Scopino sospeso**  
Escobillero de pared | Wall toilet brush holder | Toilettenbürste Wandmodell | Porte-balai mural  
cm 9,5 x 9,5 x h 55

**Art. 6212 Scopino a terra**  
Escobillero de suelo | Toilet brush holder | Toilettenbürste | Porte-balai  
cm 9,5 x 9,5 x h 55

## FINITURE



KK

### Bicchieri, portasapone, dosatore

Vaso, jabonera y dosificador | Glass, soap holder and soap dispenser  
Glas, Seifenhalter, Seifenspender | Verre, porte-savon, doseur de savon

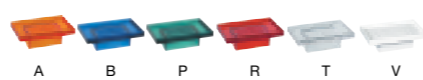

A

B

P

R

T

V

# LEM 2.T



## Serie di accessori a muro, applicazione a tassello

Accesorios de pared, se instala con taladro  
Set of wall accessories, installation with plug  
Zubehör für Wandmontage, Anbringen mit Dübel  
Accessoires à percer

Design: Studio KOH-I-NOOR e Monica Cerina



**Art. 6300 Appendino**  
Colgador | Hanger | Haken | Patère  
cm 8,5 x 3 x h3



**Art. 6316 Appendino doppio**  
Colgador doble | Double hanger | Doppelter Haken | Patère double  
cm 8,5 x 5 x h3



**Art. 6307/6304/6309 Portasalvietta**  
Toallero | Towel rack | Handtuchhalter | Porte-serviette  
cm 32/45/60 x 6,5 x h 3



**Art. 6324 Portasalvietta / Portarotolo riserva**  
Toallero / Portarollos de reserva | Towel rack / Reserve paper holder | Handtuchhalter / Reserverollenhalter | Porte-serviette / Porte-rouleaux de réserve  
cm 22 x 7,5 x h 3



**Art. 6320 Cestino contenitore**  
Contenedor | Container | Ablage | Panier  
cm 19 x 19 x h 8



**Art. 6319 Cestino contenitore**  
Contenedor | Container | Ablage | Panier  
cm 23,3 x 10,3 x h 8



**Art. 6308 Portarotolo / supporto per accessori**  
Portarollos / Soporte para accesorios | Paper holder / Support for accessories | Rollenhalter / Halterung für Accessoires | Porte-rouleaux / Support pour accessoires  
cm 11,3 x 7,5 x h 3



**Art. 6321 Cestino contenitore**  
Contenedor | Container | Ablage | Panier  
cm 19 x 19 x h 31



**Art. 6311 Scopino sospeso**  
Escobillero de pared | Wall toilet brush holder | Toilettenbürste Wandmodell | Porte-balai mural  
cm 9,5 x 9,5 x h 55



**Art. K830 Portasapone da parete in policarbonato**  
Jabonera de pared-policarbonato | Wall soap holder - polycarbonate | Wandseifenschale-Polykarbonat | Porte-savon mural-polycarbonate  
cm 14,5 x 9 x h 4,5



**Art. K838 Bicchieri da parete in policarbonato**  
Portavasos de pared-policarbonato | Wall cup-polycarbonate | Wandbecher-Polykarbonat | Verre mural-polycarbonate | Doseur mural-cristal acide  
cm 8,5 x 5,5 x h 12



**Art. K857 Dispenser da parete in policarbonato**  
Dosificador de pared-policarbonato | Wall soap dispenser-polycarbonate | Wandseifenspender-Polykarbonat | Doseur mural-polycarbonate  
cm 8,5 x 5,5 x h 16,5

## FINITURE



KK

### Bicchieri, portasapone, dosatore

Vaso, jabonera y dosificador | Glass, soap holder and soap dispenser  
Glas, Seifenhalter, Seifenspender | Verre, porte-savon, doseur de savon

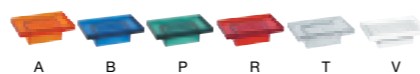

A B P R T V

## Materiali

Aste: acciaio inox cromato.  
Griglie: ottone cromato.  
Supporti: alluminio cromato.  
Bicchiere, portasapone, dosatore per sapone liquido, scopino: policarbonato e ABS.

## Materiales

Barras: acero inoxidable cromado. Rejillas: latón cromado. Soportes: aluminio cromado.  
Vaso, jabonera y dosificado, escobillero: policarbonato y ABS.

## Materials

Bars: Chromed stainless steel. Grids: chromed brass. Supports: chromed aluminium.  
Glass, soap holder and soap dispenser. Toilet brush holder: polycarbonate and ABS.

## Material

Stangen: verchromter Edelstahl. Ablagen: verchromtes Messing. Halterungen: verchromtes Aluminium.  
Glas, Seifenhalter, Seifenspender, Bürstengaritur: Polykarbonat, ABS.

## Matériaux

Tiges: acier inox chromé. Paniers: laiton chromé. Supports: aluminium chromé. Verre, porte-savon, doseur de savon liquide, porte-balai : polycarbonate et ABS.

# TUBINA TUBINA.T



# TUBINA

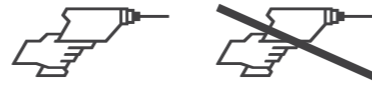

## Serie di accessori a muro, applicazione con adesivo 3M o con tassello

Accesorios de pared, se instala con adhesivo 3M o taladro  
 Set of wall accessories, installation with adhesive 3M or plug  
 Zubehör für Wandmontage, Anbringen mit 3M Klebeband oder Dübel  
 Accessoires, s'applique avec adhésif 3M ou perceuse

Design: Studio KOH-I-NOOR



**Art. 6800 Appendino**  
 Colgador | Hanger | Haken | Patère  
 ø cm 6 x 4,5



**Art. 6807/6804/6809 Portasalviette**  
 Toallero | Towel rack | Handtuchhalter | Porte-serviette  
 cm 36/49/64 x 8 x h 6



**Art. 6824 Portasalviette / Portarotolo riserva**  
 Toallero / Portarrollos de reserva | Towel rack / Reserve paper holder | Handtuchhalter / Reserverollenhalter | Porte-serviette / Porte-rouleaux de réserve  
 cm 25 x 8 x h 6



**Art. 6806 Portasalviette a snodo**  
 Toallero giratorio | Turning towel rack | Schwenkbarer Handtuchhalter | Porte-serviette pivotant  
 cm 36 x 6 x h 14



**Art. 6815+K630 Portasapone in policarbonato**  
 Jabonera policarbonato | Soap holder - polycarbonate | Wandseifenschale-Polykarbonat | Porte-savon polycarbonate  
 cm 13 x 9 x h 8,5



**Art. 6815+K638 Bicchiere in policarbonato**  
 Portavasos policarbonato | Cup-polycarbonate | Wandbecher-Polykarbonat | Verre polycarbonate  
 cm 10 x 9 x h 17



**Art. 6815+K657 Dispenser in policarbonato**  
 Dosificador policarbonato | Soap dispenser-polycarbonate | Wandseifenspender-Polykarbonat | Doseur polycarbonate  
 cm 10 x 9 x h 23,5



**Art. 6808 Portarotolo**  
 Portarrollos | Paper holder | Rollenhalter | Porte-rouleaux  
 cm 20 x 8 x h 6



**Art. 6815+K930 Portasapone vetro acidato**  
 Jabonera dcristal al ácido | Soap holder-acidified glass | Wandseifenschale-gesäuertes Kristallglas | Porte-savon cristal acidé  
 cm 13 x 9 x h 8,5



**Art. 6815+K938 Bicchiere vetro acidato**  
 Portavasos cristal al ácido | Cup acidified glass | Wandbecher-gesäuertes Kristallglas | Verre cristal acidé  
 cm 10 x 9 x h 17



**Art. 6815+K957 Dispenser vetro acidato**  
 Dosificador cristal al ácido | Soap dispenser-acidified glass | Wandseifenspender-gesäuertes Kristallglas | Doseur cristal acidé  
 cm 10 x 9 x h 23,5



**Art. 6810 Portarotolo chiuso**  
 Portarrollos | Paper holder | Rollenhalter | Porte-rouleaux  
 cm 14 x 10,5 x h 9



**Art. 6112 Scopino a terra**  
 Escobillero de suelo | Toilet brush holder | Toilettenbürste | Porte-balai  
 ø cm 9 x h 38

**Art. 6811 Scopino sospeso**  
 Escobillero de pared | Wall toilet brush holder | Toilettenbürste Wandmodell | Porte-balai mural  
 ø cm 9 x h 38

## Materiali

Aste: alluminio cromato.  
 Supporti: ottone cromato.  
 Bicchiere, portasapone, dosatore per sapone liquido: policarbonato o cristallo acidato. Scopino: ABS cromato. Viteria: acciaio inox.

## Materiales

Barras: aluminio cromado.  
 Soportes: latón cromado.  
 Vaso, jabonera y dosificador: cristal al ácido. o policarbonato. Escobillero: ABS cromado. Tornillería: acero inoxidable.

## Materials

Bars: chromed aluminium.  
 Supports: chromed brass.  
 Glass, soap holder and soap dispenser: acidified glass or transparent polycarbonate. Toilet brush holder: chromed ABS. Fittings: stainless steel

## Material

Stangen: verchromtes Aluminium.  
 Halterungen: verchromtes Messing.  
 Glas, Seifenhalter, Seifenspender: gesäuertes Kristallglas oder transparentes Polykarbonat.  
 Toilettenbürste: Verchromtes ABS.  
 Schrauben: Edelstahl.

## Matériaux

Tiges: aluminium chromé.  
 Supports: laiton chromé.  
 Verre, porte-savon, doseur de savon liquide: cristal acidé ou polycarbonate transparent.  
 Porte-balai: ABS chromé.  
 Visserie: acier inox.

## FINITURE



KK

# TUBINA.T



## Serie di accessori a muro, applicazione a tassello

Accesorios de pared, se instala con taladro  
Set of wall accessories, installation with plug  
Zubehör für Wandmontage, Anbringen mit Dübel  
Accessoires à percer

Design: Studio KOH-I-NOOR



**Art. 6900 Appendino**  
Coigador | Hanger | Haken | Patère  
ø cm 6 x 4,5



**Art. 6907/6904/6909 Portasalviette**  
Toallero | Towel rack | Handtuchhalter | Porte-serviette  
cm 36/49/64 x 8 x h 6



**Art. 6924 Portasalviette / Portarotolo riserva**  
Toallero / Portarrollos de reserva | Towel rack / Reserve paper holder | Handtuchhalter / Reserverollenhalter | Porte-serviette / Porte-rouleaux de réserve  
cm 25 x 8 x h 6



**Art. 6906 Portasalviette a snodo**  
Toallero giratorio | Turning towel rack | Schwenkbarer Handtuchhalter | Porte-serviette pivotant  
cm 36 x 6 x h 14



**Art. 6915+K630 Portasapone in policarbonato**  
Jabonera policarbonato | Soap holder - polycarbonate | Wandseifenschale-Polykarbonat | Porte-savon polycarbonate  
cm 13 x 9 x h 8,5



**Art. 6915+K638 Bicchiere in policarbonato**  
Portavasos policarbonato | Cup-polycarbonate | Wandbecher-Polykarbonat | Verre polycarbonate  
cm 10 x 9 x h 17



**Art. 6915+K657 Dispenser in policarbonato**  
Dosificador policarbonato | Soap dispenser-polycarbonate | Wandseifenspender-Polykarbonat | Doseur polycarbonate  
cm 10 x 9 x h 23,5



**Art. 6908 Portarotolo**  
Portarrollos | Paper holder | Rollenhalter | Porte-rouleaux  
cm 20 x 8 x h 6



**Art. 6915+K930 Portasapone vetro acidato**  
Jabonera dcristal al ácido | Soap holder-acidified glass | Wandseifenschale-gesäuertes Kristallglas | Porte-savon cristal acidé  
cm 13 x 9 x h 8,5



**Art. 6915+K938 Bicchiere vetro acidato**  
Portavasos cristal al ácido | Cup acidified glass | Wandbecher-gesäuertes Kristallglas | Verre cristal acidé  
cm 10 x 9 x h 17



**Art. 6915+K957 Dispenser vetro acidato**  
Dosificador cristal al ácido | Soap dispenser-acidified glass | Wandseifenspender-gesäuertes Kristallglas | Doseur cristal acidé  
cm 10 x 9 x h 23,5



**Art. 6910 Portarotolo chiuso**  
Portarrollos | Paper holder | Rollenhalter | Porte-rouleaux  
cm 14 x 10,5 x h 9



**Art. 6112 Scopino a terra**  
Escobillero de suelo | Toilet brush holder | Toilettenbürste | Porte-balai  
ø cm 9 x h 38

**Art. 6911 Scopino sospeso**  
Escobillero de pared | Wall toilet brush holder | Toilettenbürste Wandmodell | Porte-balai mural  
ø cm 9 x h 38

### Materiali

Aste: alluminio cromato.  
Supporti: ottone cromato.  
Bicchieri, portasapone, dosatore per sapone liquido: policarbonato o cristallo acidato. Scopino: ABS cromato. Viteria: acciaio inox.

### Materiales

Barras: aluminio cromado.  
Soportes: latón cromado.  
Vaso, jabonera y dosificador: cristal al ácido. o policarbonato. Escobillero: ABS cromado. Tornillería: acero inoxidable.

### Materials

Bars: chromed aluminium.  
Supports: chromed brass.  
Glass, soap holder and soap dispenser: acidified glass or transparent polycarbonate.  
Toilet brush holder: chromed ABS. Fittings: stainless steel

### Material

Stangen: verchromtes Aluminium.  
Aluminium. Halterungen: verchromtes Messing. Glas, Seifenhalter, Seifenspender: gesäuertes Kristallglas oder transparentes Polykarbonat.  
Toilettenbürste: Verchromtes ABS. Schrauben: Edelstahl.

### Matériaux

Tiges: aluminium chromé.  
Supports: laiton chromé.  
Verre, porte-savon, doseur de savon liquide: cristal acidé ou polycarbonate transparent.  
Porte-balai: ABS chromé. Visserie: acier inox.

## FINITURE



KK

# LA TONDA LA TONDA.T



# LA TONDA



## Serie di accessori a muro, applicazione con adesivo 3M

Accesorios de pared, se instala con adhesivo 3M  
 Set of wall accessories, installation with adhesive 3M  
 Zubehör für Wandmontage, Anbringen mit 3M Klebeband  
 Accessoires à coller, s'applique avec adhésif 3M

Design: Studio KOH-I-NOOR e Monica Cerina



**Art. 6400 Appendino**  
 Colgador | Hanger | Haken | Patère  
 cm 6 x 4,5 x h 7



**Art. 6401 Portasalvietta**  
 Toallero | Towel rack | Handtuchhalter | Porte-serviette  
 cm 8 x 8,5 x h 10,5



**Art. 6425 Porta phon**  
 Porta secador | Holder for hair-dryer | Halterung für Föhn | Support pour sèche-cheveux  
 cm 8 x 11 x h 11



**Art. 6408 Portarotolo**  
 Portarrollos | Paper holder | Rollenhalter | Porte-rouleaux  
 cm 11 x 12 x h 8



**Art. 6426 Portasapone vetro acidato**  
 Jabonera de cristal al ácido | Soap holder-acidified glass |  
 Wandseifenschale-gesäuertes Kristallglas | Porte-savon cristal acidé  
 cm 11,5 x 13 x h 12



**Art. 6427 Bicchieri vetro acidato**  
 Portavasos cristal al ácido | Cup acidified glass | Wandbecher-gesäuertes Kristallglas | Verre cristal acidé  
 cm 8 x 11 x h 20

## FINITURE



KK

## Materiali

Alluminio cromato

## Materiales

Aluminio cromado.

## Materials

Chromed aluminium.

## Material

Verchromtes Aluminium.

## Matériaux

Aluminium chromé.





# LA TONDA.T



## Serie di accessori a muro, applicazione a tassello

Accesorios de pared, se instala con taladro  
 Set of wall accessories, installation with plug  
 Zubehör für Wandmontage, Anbringen mit Dübel  
 Accessoires à percer

Design: Studio KOH-I-NOOR e Monica Cerina



**Art. 6500 Appendino**  
 Colgador | Hanger | Haken | Patère  
 cm 6 x 4,5 x h 7



**Art. 6501 Portasalviette**  
 Toallero | Towel rack | Handtuchhalter | Porte-serviette  
 cm 8 x 8,5 x h 10,5



**Art. 6525 Porta phon**  
 Porta secador | Holder for hair-dryer | Halterung für Föhn | Support pour sèche-cheveux  
 cm 8 x 11 x h 11



**Art. 6508 Portarotolo**  
 Portarrollos | Paper holder | Rollenhalter | Porte-rouleaux  
 cm 11 x 12 x h 8



**Art. 6526 Portasapone vetro acidato**  
 Jabonera de cristal al ácido | Soap holder-acidified glass |  
 Wandseifenschale-gesäuertes Kristallglas | Porte-savon cristal acide  
 cm 11,5 x 13 x h 12



**Art. 6527 Bicchiere vetro acidato**  
 Portavasos cristal al ácido | Cup acidified glass | Wandbecher-gesäuertes Kristallglas | Verre cristal acide  
 cm 8 x 11 x h 20

## FINITURE



KK

## Materiali

Alluminio cromato

## Materiales

Aluminio cromado.

## Materials

Chromed aluminium.

## Material

Verchromtes Aluminium.

## Matériaux

Aluminium chromé.



# GRIGLIE



## Serie di accessori a muro, applicazione con adesivo 3M

Accesorios de pared, se instala con adhesivo 3M  
 Set of wall accessories, installation with adhesive 3M  
 Zubehör für Wandmontage, Anbringen mit 3M Klebeband  
 Accessoires à coller, s'applique avec adhésif 3M

Design: Studio KOH-I-NOOR



**Art. 5798 + 45802 Cestino contenitore**  
 Contenedor | Container | Ablage | Panier  
 cm 23,3 x 12 x h 7,5/5



**Art. 5798+45806 Cestino contenitore**  
 Contenedor | Container | Ablage | Panier  
 cm 19 x 19 x h 8/11,7



**Art. 5798+45803 Cestino contenitore**  
 Contenedor | Container | Ablage | Panier  
 cm 19 x 19 x h 31/34,7

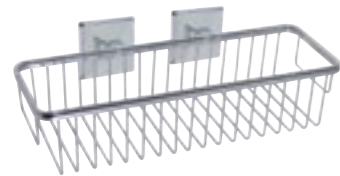

**Art. 5798+45807 Cestino contenitore**  
 Contenedor | Container | Ablage | Panier  
 cm 35 x 12 x h 8/11,7

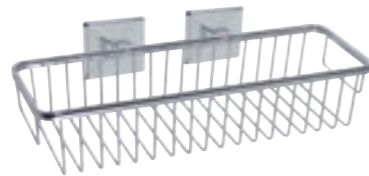

**Art. 5798+45808 Cestino contenitore**  
 Contenedor | Container | Ablage | Panier  
 cm 45 x 12 x h 8/11,7



**Art. 5798 + 45809 Cestino contenitore**  
 Contenedor | Container | Ablage | Panier  
 cm 23,3 x 10,3 x h 8/11,7



**Art. 5798 x 2 + 45811 Mensola portasalviette**  
 Toallero estante | Towel shelf | Handtuchablage | Étagère porte-serviettes  
 cm 50 x 29 x h 20



**Art. 6198+45802 Cestino contenitore**  
 Contenedor | Container | Ablage | Panier  
 cm 23,3 x 10,3 x h 5/8,7



**Art. 6198+45806 Cestino contenitore**  
 Contenedor | Container | Ablage | Panier  
 cm 19 x 19 x h 8/11,7



**Art. 6198+45803 Cestino contenitore**  
 Contenedor | Container | Ablage | Panier  
 cm 19 x 19 x h 31/34,7



**Art. 6198+45807 Cestino contenitore**  
 Contenedor | Container | Ablage | Panier  
 cm 35 x 12 x h 8/11,7



**Art. 6198+45808 Cestino contenitore**  
 Contenedor | Container | Ablage | Panier  
 cm 45 x 12 x h 8/11,7



**Art. 6198+45809 Cestino contenitore**  
 Contenedor | Container | Ablage | Panier  
 cm 23,3 x 10,3 x h 8/11,7



**Art. 6198 x 2 + 45811 Mensola portasalviette**  
 Toallero estante | Towel shelf | Handtuchablage | Étagère porte-serviettes  
 cm 50 x 29 x h 20

## FINITURE



KK

# GRIGLIE.T



## Serie di accessori a muro, applicazione a tassello

Accesorios de pared, se instala con taladro  
Set of wall accessories, installation with plug  
Zubehör für Wandmontage, Anbringen mit Dübel  
Accessoires à percer

| Materiali       | Materiales     | Materials      | Material             | Matériaux      |
|-----------------|----------------|----------------|----------------------|----------------|
| Ottone cromato. | Latón cromado. | Chromed brass. | Verchromtes Messing. | Laiton chromé. |

Design: Studio KOH-I-NOOR

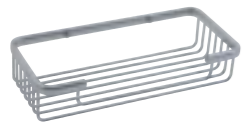

**Art. 45802 Cestino contenitore**  
Contenedor | Container | Ablage | Panier  
cm 23,3 x 10,5 x h 7,5/5



**Art. 45806 Cestino contenitore**  
Contenedor | Container | Ablage | Panier  
cm 19 x 19 x h 8

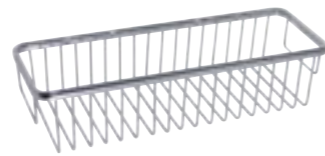

**Art. 45807/45808 Cestino contenitore**  
Contenedor | Container | Ablage | Panier  
cm 35/45 x 12 x h 8



**Art. 45809 Cestino contenitore**  
Contenedor | Container | Ablage | Panier  
cm 23,9 x 10,5 x h 8

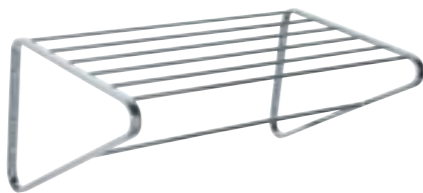

**Art. 45811 Mensola portasalviette**  
Toallero estante | Towel shelf | Handtuchablage | Étagère porte-serviettes  
cm 50 x 29 x h 20

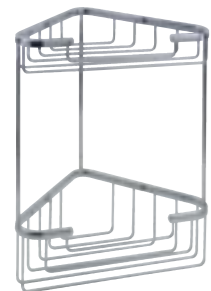

**Art. 45803 Cestino contenitore**  
Contenedor | Container | Ablage | Panier  
cm 19 x 19 x h 31



**Art. 45812 Mensola portasalviette**  
Toallero estante | Towel shelf | Handtuchablage | Étagère porte-serviettes  
cm 50 x 29 x h 20



**Art. 45810**  
Contenedor | Container | Ablage | Panier  
cm 23,3 x 11 x h 76

## FINITURE



KK

# MANIGLIONI



## Maniglioni di sicurezza

Manillón-asa de seguridad  
Safety grab rail  
Sicherheitswandgriff  
Poignée de sécurité

| Materiali             | Materiales          | Materials                | Material               | Matériaux          |
|-----------------------|---------------------|--------------------------|------------------------|--------------------|
| Acciaio inox cromato. | Acero inox cromado. | Chromed stainless steel. | Verchromter Edelstahl. | Acier inox chromé. |

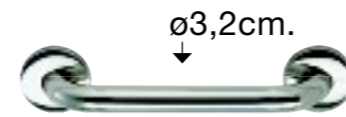

**Art. 45105/45106 Maniglione**  
Manillón-asa baño | Grab rail | Wandgriff | Poignée  
cm 38/48 x 8 x h 8

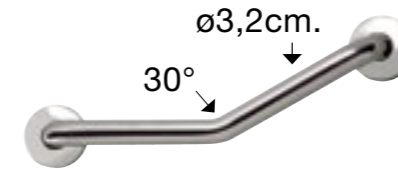

**Art. 45107 Maniglione**  
Manillón-asa baño | Grab rail | Wandgriff | Poignée  
cm 49 x 8 x h 8

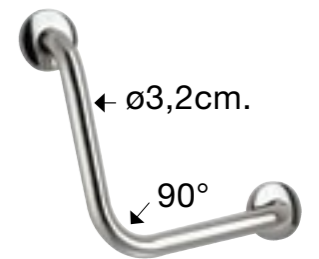

**Art. 45108 Maniglione**  
Manillón-asa baño | Grab rail | Wandgriff | Poignée  
cm 30 x 8 x h 8

## FINITURE



KK

Design: Studio KOH-I-NOOR



**Art. 5036**  
cm 40 x 18 x h 70



**Art. 5035**  
cm 40 x 18 x h 70



**Art. 5034**  
cm 40 x 21 x h 89



**Art. 5037**  
cm 28 x 18 x h 76



**Art. 5038**  
cm 28 x 18 x h 76

## FINITURE



KK

## Materiali

Struttura in ottone cromato, base in ABS cromato, accessori in metacrilato e policarbonato. Scopino: ABS cromato.

## Materiales

Estructura de latón cromado, base ABS cromada, accesorios en metacrilato y policarbonato. Escobillero: ABS cromo.

## Materials

Structure of chromed brass, base chromed ABS, accessories of methacrylate and polycarbonate. Toilet brush: chromed ABS.

## Material

Gestell aus verchromtem Messing, Basis verchromtes ABS, Zubehör aus Methacrylat und Polykarbonat. Toilettenbürste: verchromtes ABS.

## Matériaux

Structure en laiton chromé, base ABS chromé, accessoires en méthacrylate et polycarbonate. Porte-balai: ABS chrome.



# KOKO

Design: Studio KOH-I-NOOR



**Art. 5031**  
ø cm 18 x h 62



**Art. 5032**  
cm 20 x ø 18 x h 62



**Art. 5030**  
cm 33 x ø 23 x h 88



**Art. 5033**  
cm 20 x ø 18 x h 70

## FINITURE



### Materiali

Struttura in ottone cromato, base in ABS cromato, accessori in ABS cromato.

### Materiales

Estructura de latón cromado, base en ABS cromada, accesorios en ABS cromado.

### Materials

Structure of chromed brass, base chromed ABS, accessories of chromed ABS.

### Material

Gestell aus verchromtem Messing, Basis aus verchromtem ABS, Zubehör aus verchromtem ABS.

### Matériaux

Structure en laiton chromé, base ABS chromé, accessoires en ABS chromé.

