

**REMER**  
RUBINETTERIE



MADE IN ITALY 

**CATALOGO** 18-19





# REMER

RUBINETTERIE



MADE IN ITALY  
🇮🇹

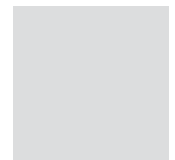
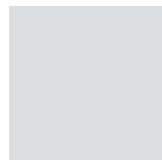

# CATALOGO

18-19

# ARREDARE

## DESIGN

## EASY CONTEMPORARY



Vanity P. 10



Infinity P. 20



Dream P. 30



Atmos P. 40



Class Line P. 46



Winner P. 58

## ECO

## TERMOSTATICI



Class Line Eco P. 138



Winner Eco P. 142



Elegance P. 146



Q-Elegance P. 152



Minimal Thermo P. 156



Qubika Thermo P. 166



Thermo P. 174

## CLASSICA

## SENSOR & TEMPOR



Liberty P. 217



Musa P. 220



1000-2000 P. 226



SENSOR COLOR  
LED LIGHT  
Sensor Color P. 234



Sensor P. 238



Tempor Touch P. 244



Tempor P. 248

# ARREDARE

## TECNOLOGIA ED ELEGANZA IN CUCINA



Touch-Me Elegant kitchen P. 302



Touch-Me Gourmet P. 303



Touch-Me P. 304



Touch-Me Color P. 305



Color P. 306



Ambient P. 307



Acqua Depurata Elettronico P. 308



Acqua Depurata P. 309

# WELLNESS



Box Incasso P. 330



Kit Wellness P. 336



Cromoterapia P. 358



Bracci e Soffioni P. 366



Pannelli Docci P. 380



Colonne Doccia P. 384



Saliscendi P. 406



Doccette P. 416



Shut-Off P. 424



Kit Bordo Vasca P. 436



Bocche P. 440



Flessibili Doccia P. 444

## DESIGN MINIMALE



X Style P. 70



Minimal P. 78



Jazz P. 96



Q Design P. 104



Qubika P. 112



SQ3 P. 128

## TECNOLOGIA E COLORE



Q-Color P. 178



Q-Ambient P. 184



Minimal Color P. 188

## DESIGN WATERFALL



Flash P. 196



Qubika Cascata P. 204

## CONTRACT



Project P. 254



Ten P. 258



Giga Four P. 262



Kiss P. 266



Remix P. 272



35 P. 276



100 P. 280



Accessori per Rubinetteria P. 282

# LA CUCINA

## L'ELEGANZA IN CUCINA



Elegant Gourmet P. 310



Elegant Kitchen P. 314



Cucina P. 316



Gourmet P. 318



Gourmet Coor P. 322



Bordo Lavello P. 324



304 INOX P. 326

# ACCESSORI BAGNO



LOUNGE P. 452



FLAT P. 454



DELICATA P. 456



MINIMAL INOX P. 458



900 P. 460



SQ P. 462



FORMA P. 464



ARTE P. 466



SUITE P. 468



EPOCA P. 470



Accessori P. 472



Idroscopini P. 476

# IL GRUPPO REMER

LAVORA PER SUPERARE SE STESSO E PER  
OFFRIRVI SEMPRE NUOVE SOLUZIONI



Remer Rubinetterie, fondata a Milano nel 1965, è un'azienda Leader nella produzione di rubinetteria e minuteria idraulica, partner affidabile, serio e ben conosciuto sui mercati italiani ed internazionali da oltre 50 anni.

Remer è da sempre orientata a soddisfare le necessità di un mercato in costante cambiamento e costruire stabili relazioni commerciali. Le produzioni Remer sono attualmente distribuite in 140 Nazioni creando un importante riconoscimento del marchio e prodotti Remer a livello mondiale.

Per poter fare grandi numeri, Remer si è dotata di grandi impianti produttivi investendo in strutture, macchinari e tecnologie per dare ai clienti una maggiore sicurezza sulla qualità e l'origine del prodotto.

Internamente ai propri stabilimenti, tra Milano e Bergamo, nei Remer Engineering Labs, dedicati alla produzione ad alta precisione con macchinari fortemente innovativi e completamente robotizzati, Remer chiude il ciclo produttivo di gran parte dei propri articoli. Tutto il percorso di creazione del prodotto è quindi interno all'azienda sin dalle prime fasi di creazione del design, progettazione e prototipazione degli articoli, in quanto Remer è dotata di un reparto ricerca e sviluppo e di un reparto tecnico tra i più corposi e creativi del nostro settore, oltre che di strumenti modernissimi.

Dopo un'attenta selezione e controllo dei migliori fornitori di materia prima Remer passa alla fase produttiva utilizzando solo macchinari italiani e altamente all'avanguardia adatti per la lavorazione di articoli fusi, stampati, da barra, da tubo e da lastra di ottone, praticamente il panorama completo.

Pulitura, cromatura e verniciatura interni all'azienda definiscono e chiudono il ciclo del prodotto. Un reparto di stampaggio delle materie plastiche definisce poi la struttura corporosa del Gruppo, insieme al reparto produzione tubi trecciati ed altro ancora.

Test e montaggio scrupolosi e impeccabili danno a ciascun prodotto la garanzia di essere stato pensato e realizzato per durare nel tempo.

Tramite i propri impianti produttivi Remer Rubinetterie riesce quindi a dare alla clientela una triplice garanzia sul prodotto: la certezza della sua origine, la sicurezza di totale qualità e la migliore competitività sul mercato.

Remer Rubinetterie, per sua natura, si impegna costantemente per crescere, investire, costruire, ideare, progettare, creare e perfezionare, per dare nuovi risultati e nuovi stimoli ad ogni stagione.

Abbiamo puntato sull'alta tecnologia per rispondere positivamente alle necessità di un mercato sempre più esigente e la ricerca di nuove soluzioni rappresenta il motore trainante del nostro Gruppo. Remer Rubinetterie vi invita dunque non solo ad apprezzare le nuove linee di prodotti ma anche ad effettuare un giro virtuale delle nostre aziende attraverso il video di presentazione che trasmette a livello visivo un piccolo assaggio delle nostre potenzialità produttive.

Attualmente strutturata su di un'area di 90.000 mq di cui 47.000 coperti e 2000 mq di soli uffici, l'azienda è certificata ISO 9001, sistema di qualità aziendale, e ISO 14001, sistema di qualità ambientale.

Remer Rubinetterie S.p.A., sempre attenta anche agli aspetti ambientali ha inaugurato nel Marzo 2011 un grandissimo impianto fotovoltaico che crea energia pulita per 500KWp, pari al fabbisogno energetico di circa 200 famiglie ed è prossima ad inaugurare un nuovo impianto pari ad altri 1000KWp raggiungendo a breve i 1500KWp totali e portando le proprie lavorazioni e produzioni in un'area completamente GREEN.

Questa è Remer Rubinetterie, questo è il nostro Gruppo e lavoriamo con passione.

Siamo sicuri che apprezzerete questo nuovo catalogo e listino, strumento indispensabile per gli addetti ai lavori ed espressione di un servizio che va oltre la semplice proposta di vendita ma è simbolo di una vera collaborazione tecnico-commerciale.

*Antonio Repici*



REMER sede operativa e uffici amministrativi.



REMER ENGINEERING 1  
produzione high-tech, R&D.



REMER ENGINEERING 2  
produzione high-tech.



# REMER | LA FORZA DI UN GRANDE GRUPPO

Pulitura, Controllo qualità,  
Pre-assemblaggio,  
Stampaggio plastico, Logistica.

Sede operativa e  
uffici amministrativi

ENGINEEREENG 2  
produzione  
high-tech

REMER  
STORE

ENGINEEREENG 1  
produzione high-tech

 **FLEXITALY**  
produzione  
flessibili



Cassano d'Adda (MI) - Italy  
Lat: 45° 31' 37" N Long: 9° 30' 11" E

sede storica



REMER Pulitura. Controllo qualità, Pre-assemblaggio,  
Stampaggio plastico, Logistica.

FLEXITALY: produzione flessibili.

# LA NOSTRA FORZA

## LA NOSTRA FORZA È DETERMINATA DA DIVERSI FATTORI:

- Produzione interna di articoli fusi, stampati, da barra, da lastra e da tubo di ottone
- Produzione interna di componenti in plastica
- 100% prodotto testato e garantito
- Linee di assemblaggio automatiche
- Tutta la produzione, l'assemblaggio e la logistica automatizzata, robotizzata e computerizzata
- Rapidità di consegna e disponibilità costante del prodotto
- Produzione interna di svariate componentistiche incluse cartucce, vitoni, flessibili, deviatori e molto altro
- 100% ciclo di produzione interno incluse pulitura e cromatura e verniciatura
- 100% materia prima di qualità per un prodotto conforme
- Circa 100 postazioni in radio frequenza
- Produzione interna di packaging
- Assistenza vendite e post vendita con servizio di qualità



## LE NOSTRE CERTIFICAZIONI:

Remer Rubinetterie S.p.A. è un'azienda certificata UNI EN ISO 9001:2008 sistema di gestione qualità aziendale e UNI EN ISO 14001:2004 per l'impatto ambientale.







**SOLO CARTUCCE E COMPONENTI  
ELETTRONICI DI ALTA QUALITÀ E  
MADE IN ITALY**



Tutti i miscelatori ed i prodotti a contenuto elettronico REMER godono di una garanzia di qualità aggiuntiva.

Cartucce a dischi ceramici per monocomando, deviatori per doccia, cartucce termostatiche e componenti elettronici sono tutti prodotti in Italia da S.T.S.R. - Studio Tecnico Sviluppo e Ricerche - con stabilimenti a Lacchiarella - MI - e sito internet [www.stsr.it](http://www.stsr.it)

S.T.S.R. nasce nel 1985 come Studio Tecnico di Sviluppo e Ricerca della Multinazionale Masco producendo nel corso degli anni svariati brevetti sia relativi a cartucce che a prodotti elettronici.

Al suo interno sono presenti macchinari all'avanguardia che coprono il ciclo produttivo dallo stampaggio delle speciali plastiche utilizzate fino all'assemblaggio e test su macchine automatiche di ultima generazione.

Inoltre in S.T.S.R. è presente un laboratorio di analisi molto attrezzato che compie quotidianamente svariati test sui propri modelli per mantenere il controllo sulle performance dei propri prodotti.

I prodotti S.T.S.R. godono inoltre di svariate Certificazioni.

È per noi importante dotare i nostri miscelatori di una cartuccia di alta qualità; i nostri clienti possono così apprezzare un acquisto che dia garanzia di affidabilità a lungo termine ed evitare le lunghe contestazioni in cui si incorre nel momento in cui il miscelatore viene dotato di cartucce di scarsa qualità e talvolta con misure non facilmente reperibili sul mercato, divenendo un danno di immagine oltre che di sostanza.

Questo valore aggiunto dona agli articoli REMER caratteristiche superiori a conferma di qualità e del nostro made in ITALY.



**SOLO FLESSIBILI MADE IN ITALY DI ALTA QUALITÀ  
PRODOTTI CON MACCHINARI AUTOMATIZZATI  
A GARANZIA DI ELEVATI STANDARD**

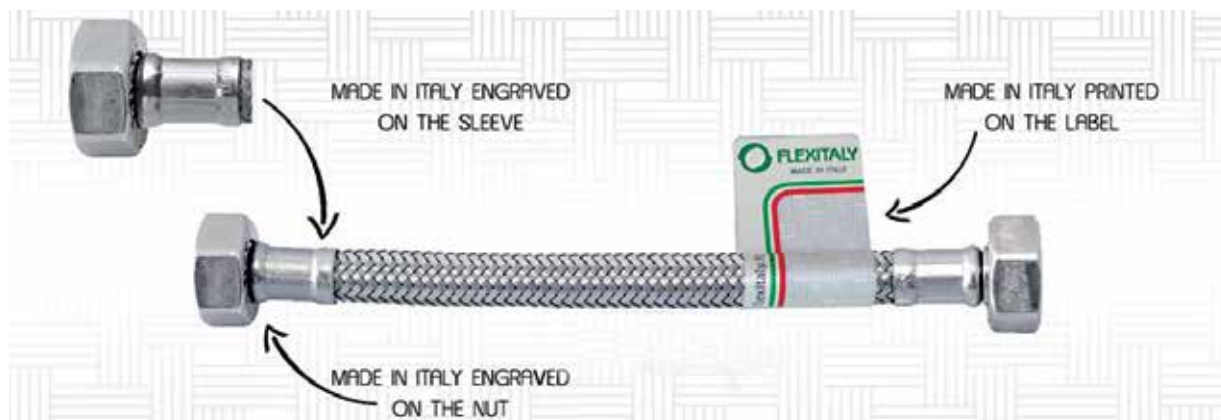

I prodotti REMER utilizzano solamente flessibili di alta qualità prodotti in Italia con macchinari automatizzati a garanzia di elevati standard.

Flexitaly s.r.l., è una azienda facente parte del Gruppo REMER. Nata nel 1985, Flexitaly è dotata di propri stabilimenti ed impianti che iniziano il processo produttivo partendo dalla trecciatura del tubo (gomma epdm e filo secondo specifica) e, con l'ausilio di minuterie e raccorderie create internamente con i migliori materiali seguendo

minuziosamente le tolleranze e macchine automatizzate specifiche, coprono l'intero ciclo produttivo, rendendo alla clientela un prodotto completamente made in italy, ideato e poi creato per essere totalmente performante, atossico ed estremamente durevole nel tempo.

Un ulteriore plus per i prodotti REMER.



MADE IN ITALY 

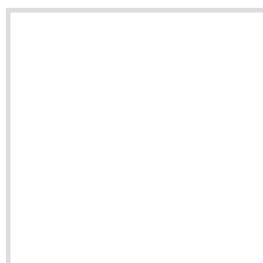
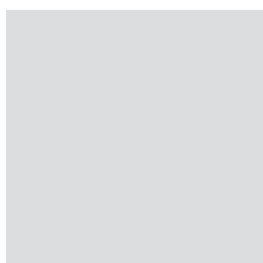
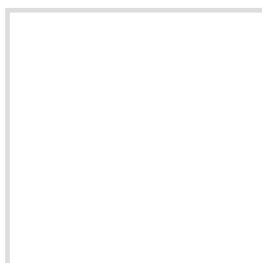

**REMER**  
RUBINETTERIE





# COLLEZIONE 18-19

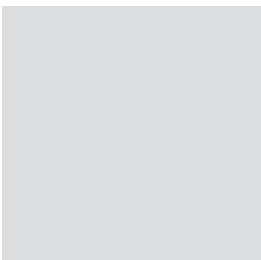
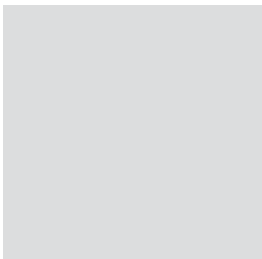
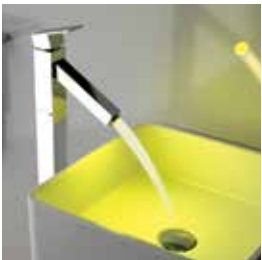
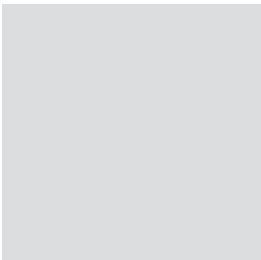
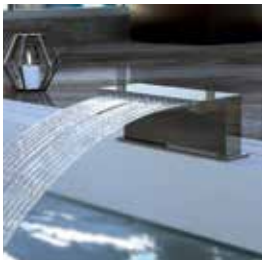

# VANITY

## CARATTERISTICHE TECNICHE:

La serie è dotata di cartuccia a dischi ceramici, Ø 35 mm, prodotta da S.T.S.R. – Studio Tecnico Sviluppo e Ricerche - [www.stsr.it](http://www.stsr.it)

VANITY

INFINITY

DREAM

ATMOS

CLASS LINE

WINNER





**SIMBOLOGIE:**

- |   |   |  |   |  |   |  |  |  |   |   |   |
|---|---|--|---|--|---|--|--|--|---|---|---|
| <br>Con scarico con troppo pieno | <br>Senza scarico                            | <br>Con scarico in plastica               | <br>Con Click-Clack con Troppo Pieno | <br>Proporzione perfetta. | <br>Con Kit Doccia e flessibile lungo: 120, 150 o 200 cm | <br>Doccetta Anticalcare            | <br>Lavello sottofinestra con canna girevole | <br>Canna alta girevole | <br>Canna girevole                             | <br>Doccetta estraibile                      | <br>Doccetta orientabile                       |
| <br>Acqua Potabile             | <br>Colonna doccia girevole e telescopica. | <br>Soffione Anticalcare ed Autopulente | <br>Touch-Me                       |                         | <br>Prodotto novità                                    | <br>Con Batterie al Litio Incluse | <br>Massaggio con getto vigoroso ed ampio   | <br>Getto Esterno     | <br>Massaggio con getto vigoroso concentrato | <br>Ampio getto pioggia a risparmio idrico | <br>Getto ad ampia copertura effetto pioggia |

**LAVABI**



**V 10**  
Miscelatore monocomando lavabo.  
Altezza 181 mm, Interasse 120 mm.



**V 11**  
Miscelatore monocomando lavabo senza scarico.  
Altezza 181 mm, Interasse 120 mm.



**V 12**  
Miscelatore monocomando lavabo senza scarico e senza foro sul corpo.  
Altezza 181 mm, Interasse 120 mm.



**V 57**  
Miscelatore monocomando lavabo due fori senza scarico.



**V 10 L**  
Miscelatore monocomando lavabo.  
Altezza 320 mm, Interasse 185 mm.



**V 11 L**  
Miscelatore monocomando lavabo senza scarico.  
Altezza 320 mm, Interasse 185 mm.





VANITY

INFINITY

DREAM

ATMOS

CLASS LINE

WINNER

LAVABO BOX INCASSO



NEW

V 15

Miscelatore monocomando a incasso per lavabo, con piastra in ottone cromato, bocca lunghezza 16,5 cm.



NEW

+

V 15 KB

Miscelatore monocomando a incasso per lavabo, con piastra in ottone cromato, bocca lunghezza 16,5 cm, da abbinare al box incasso.

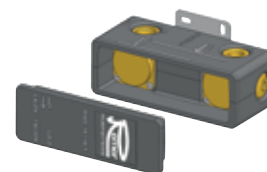

RR BOX15

Box da incasso per miscelatore monocomando a incasso per lavabo.

BIDET



NEW

V 20

Miscelatore monocomando bidet.



NEW

120 cm

V 65 W

Miscelatore incasso shut-off comprensivo di: doccetta shut-off art.332OW, supporto doccia-presa acqua, attacco conico da 1/2" e supporto shut-off, tutto in ottone cromato, flessibile doccia cm 120.



NEW

120 cm

V 60 W

Miscelatore incasso per shut-off comprensivo di: doccetta shut-off art. 332OW, supporto doccia-presa acqua su piastra in ottone cromato e flessibile doccia cm 120.



NEW

X

V 21

Miscelatore monocomando bidet senza scarico.



NEW

V 65 B

Miscelatore incasso per shut-off su piastra in ottone cromato, attacco conico da 1/2" e supporto shut-off.

## MISCELATORI VASCA E DOCCIA



**V 38**

Monocomando doccia esterno con kit doccia, flessibile 150 cm.



**V 02**

Miscelatore vasca esterno con kit doccia, flessibile 150 cm.



**V 33**

Monocomando doccia esterno senza kit doccia.



**V 05**

Miscelatore vasca esterno senza kit doccia.

## BOCCHIE ED INCASSI DOCCIA



**NEW**

**V 30**

Miscelatore doccia incasso.



**NEW**

**V 09**

Miscelatore doccia incasso con deviatore.



**NEW**

**V 92**

Miscelatore monocomando per doccia con deviatore a 2 posizioni su piastra unica.



**NEW**

**V 93**

Miscelatore monocomando per doccia con deviatore a 3 vie e 3 posizioni (una entrata e tre uscite) su unica piastra.

**L 30 B**

Parte interna miscelatore monocomando incasso doccia.

**L 09 B**

Parte interna miscelatore monocomando incasso vasca/doccia con deviatore.

**V 30 E**

Parte esterna miscelatore monocomando incasso doccia.

**V 09 E**

Parte esterna miscelatore monocomando incasso vasca/doccia con deviatore.



**NEW**

**V 93 7**

Miscelatore monocomando per doccia con deviatore a tre vie e sette posizioni (una entrata, tre uscite e sette posizioni con cui selezionare uscite singole o miscelate tra loro) su unica piastra.



**NEW**

**V 94**

Miscelatore monocomando per doccia, con deviatore a 4 posizioni (4 uscite ed 1 entrata) su piastra unica.



**NEW**

**V 95**

Miscelatore monocomando per doccia, con deviatore a 5 posizioni (5 uscite ed una entrata) su piastra unica.



**91 V**

Bocca incasso.

**NEW**

BOX INCASSO

VANITY

INFINITY

DREAM

ATMOS

CLASS LINE

WINNER



**RR BOX**  
Box da incasso per miscelatore doccia con deviatore.

**V 30 KB**  
Set miscelatore doccia da abbinare al box incasso.



**RR BOX**  
Box da incasso per miscelatore doccia con deviatore.

**V 09 KB**  
Set miscelatore doccia con deviatore da abbinare al box incasso.



**RR BOX93**  
Box da incasso per miscelatore doccia tre vie.

**V 93 KB**  
Set miscelatore doccia tre vie da abbinare al box incasso.



**RR BOX92**  
Box da incasso per miscelatore doccia due vie.

**V 92 KB**  
Set miscelatore doccia due vie da abbinare al box incasso.



**RR BOX93**  
Box da incasso per miscelatore doccia tre vie.

**V 937 KB**  
Set miscelatore doccia tre vie e sette posizioni da abbinare al box incasso.

MISCELATORI PER COLONNE DOCCIA E SALISCENDI



**V 35**  
Miscelatore doccia esterno con attacco superiore da 3/4".



**V 34**  
Miscelatore vasca/doccia con attacco superiore da 1/2" ed attacco inferiore da 1/2".



**V 34 34**  
Miscelatore vasca/doccia con attacco superiore da 3/4" ed attacco inferiore da 1/2".

## VANITY

## VANITY

*Le linee di Vanity appaiono come plasmate dagli elementi della natura e tutta la serie sprigiona sensazioni di armonia sia alla vista che al tatto.*

*La basetta diventa parte stessa del corpo miscelatore creando una figura unica e scultorea.*

*L'aeratore a scomparsa esalta la linea del prodotto donandogli ulteriore eleganza.*

*Il design della serie è stato ideato dal designer Cristian Mapelli, parte del Dipartimento di Ricerca e Sviluppo del Gruppo Remer ed ingegnerizzata e prodotta nei nostri stabilimenti produttivi situati in provincia di Milano.*







VANITY

INFINITY

DREAM

ATMOS

CLASS LINE

WINNER



### 317V 315P3I

Saliscendi cromato con asta minimale ovale, con doccetta anticalcare a 4 funzioni, pulsante per il cambio dei getti anticalcare in silicone, flessibile in acciaio inox.

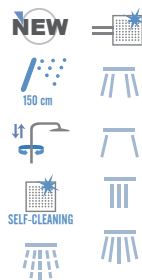
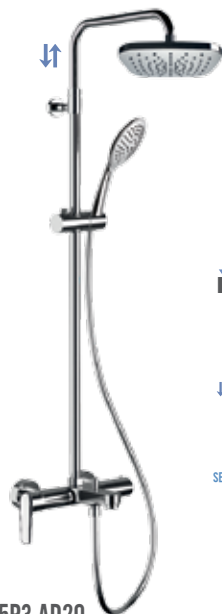

### V34 A5P3 AD20

Miscelatore vasca/doccia con attacco superiore da 3/4" ed attacco inferiore da 1/2", colonna doccia telescopica, doccetta anticalcare a 4 funzioni, con flessibile 333 CNX 150 cm e soffione a pioggia, quadrato con angoli arrotondati in abs cromato, 20x20 cm, con getti in silicone anticalcare.

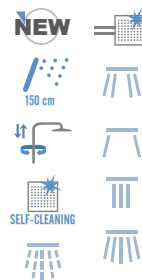

### V37 A5P3 AD20

Colonna doccia con miscelatore doccia e attacco superiore da 3/4", colonna doccia telescopica con deviatore, doccetta a 4 funzioni con getti anticalcare, con flessibile 333 CN 150 cm e soffione a pioggia, quadrato con angoli arrotondati in abs cromato, 20x20 cm, con getti in silicone anticalcare.

## WELLNESS



### V 09 S01

Set doccia composto da:  
 Art. 348N30 356AD20: soffione doccia cm 20x20 quadrato con angoli arrotondati in abs cromato, e getti anticalcare con braccio minimale in ottone cm 30.  
 Art. V09: Monocomando vasca/doccia incasso con deviatore.  
 Art. 317V 315P3 333CNX 150: saliscendi cromato con asta minimale ovale dritta, doccetta cromata a 4 funzioni, pulsante per cambio getti, anticalcare e flessibile conico in ottone cromato cm 150.  
 Art. 309L: presa acqua rotonda in ottone cromato.



### V 09 S02

Set doccia composto da:  
 Art. 348N30 356AD20: soffione doccia cm 20x20 quadrato con angoli arrotondati in abs cromato, e getti anticalcare con braccio minimale in ottone cm 30.  
 Art. V09: Monocomando vasca/doccia incasso con deviatore.  
 Art. 315P3 333CNX 150: doccetta cromata a 4 funzioni, pulsante per cambio getti, anticalcare e flessibile conico in ottone cromato cm 150.  
 Art. 337M: presa acqua e supporto in ottone cromato per flessibile con attacco conico.



CUCINA



**V 72**  
Miscelatore monocomando monoforo 90°, con canna alta a "U".



**V 72 C**  
Miscelatore monocomando per lavello, con canna corta a "U", tipo lusso.



**V 533**  
Miscelatore lavello monocomando con flessibile nero rivestito con molla "fine design" girevole 360°, con doccetta estraibile di supporto ed orientabile a due funzioni e cartuccia Ø 35.



**V 77 E**  
Miscelatore monocomando lavello a molla con doccetta estraibile dal supporto ed orientabile a due funzioni e cartuccia Ø 35.



**V 42 B**  
Miscelatore monocomando per lavello, con bocca alta girevole.



**V 42 BC**  
Miscelatore monocomando per lavello, con bocca corta girevole.

TOUCH-ME



**VT 72**  
Miscelatore monocomando lavello, monoforo 90° con canna alta ad "U" dotata di tecnologia Touch-Me con leva laterale e bocca girevole. Dotato di cartuccia Ø35.



**VT 72 C**  
Miscelatore monocomando lavello, monoforo 90° con canna corta ad "U" dotata di tecnologia Touch-Me con leva laterale e bocca girevole. Dotato di cartuccia Ø35.

ACQUA PURIFICATA



**V 79 DW**  
Miscelatore lavello a tre vie di ingresso con bocca girevole e due vie d'uscita completamente indipendenti, con selezione acqua potabile tramite la leva.

# INFINITY

## CARATTERISTICHE TECNICHE:

La serie è dotata di cartuccia a dischi ceramici, Ø 35 mm, prodotta da S.T.S.R. – Studio Tecnico Sviluppo e Ricerche - [www.stsr.it](http://www.stsr.it)



VANITY

INFINITY

DREAM

ATMOS

CLASS LINE

WINNER

**SIMBOLOGIE:**

- |   |  |   |  |   |   |   |   |   |  |   |
|---|--|---|--|---|---|---|---|---|--|---|
| <br>Con scarico con troppo pieno             | <br>Senza scarico       | <br>Con Click-Clack con Troppo Pieno | <br>Proporzione perfetta. | <br>Con Kit Doccia e flessibile lungo: 120, 150 o 200 cm | <br>Doccetta Anticalcare | <br>Colonna doccia girevole e telescopica. | <br>Soffione Anticalcare ed Autopulente      | <br>Prodotto novità      |  |   |
| <br>Lavello sottofinestra con canna girevole | <br>Canna alta girevole | <br>Canna girevole                   | <br>Doccetta estraibile   | <br>Doccetta orientabile                                 | <br>Acqua Potabile       | <br>Getto ad ampia copertura effetto pioggia | <br>Massaggio con getto vigoroso concentrato | <br>Con getto a cascata. | <br>Con multigetto. | <br>Ampio getto pioggia a risparmio idrico |

**LAVABI**

- |   |   |   |   |
|---|---|---|---|
|  <p><b>I 10</b><br/>Monocomando lavabo.<br/>Altezza 172 mm, Interasse 120 mm.</p>   |   <p><b>I 10 L</b><br/>Monocomando lavabo alto con scarico click-clack.<br/>Altezza 300 mm, Interasse 180 mm.</p>                |   <p><b>I 10 LXXL</b><br/>Miscelatore monocomando lavabo alto XXL con scarico click-clack.<br/>Altezza 495 mm, Interasse 180 mm.</p>        |   |
|   <p><b>I 11</b><br/>Monocomando lavabo, senza scarico.<br/>Altezza 172 mm, Interasse 120 mm.</p>   |   <p><b>I 11 L</b><br/>Monocomando lavabo alto, senza scarico.<br/>Altezza 300 mm, Interasse 180 mm.</p>                      |   <p><b>I 11 LXXL</b><br/>Miscelatore monocomando lavabo alto XXL senza scarico.<br/>Altezza 495 mm, Interasse 180 mm.</p>               |    <p><b>I 18</b><br/>Miscelatore monocomando lavabo da terra con scarico click-clack.<br/>Altezza 1010 mm, Interasse 180 mm.</p> |
|    <p><b>I 57</b><br/>Miscelatore monocomando lavabo due fori senza scarico.</p> |   <p><b>I 15</b><br/>Miscelatore monocomando a incasso per lavabo, con piastra in ottone cromato e bocca lunghezza 18 cm.</p> |   <p><b>I 14</b><br/>Miscelatore monocomando a incasso per lavabo, con piastra verticale in ottone cromato e bocca lunghezza cm 18.</p> |   |



LAVABO BOX INCASSO

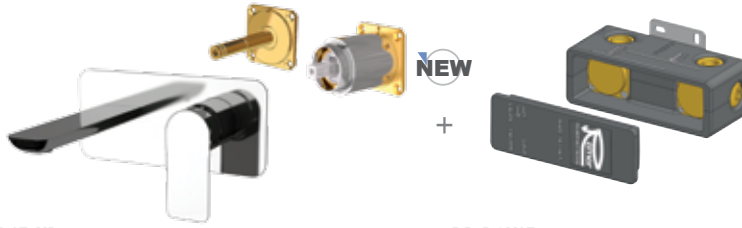

I 15 KB

Miscelatore monocomando a incasso per lavabo, con piastra in ottone cromato da abbinare al box incasso.

RR BOX15

Box da incasso per miscelatore monocomando a incasso per lavabo.

VANITY

INFINITY

BIDET



I 20

Monocomando bidet con scarico.

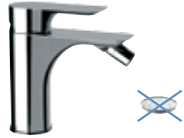

I 21

Monocomando bidet, senza scarico.



IC31

Miscelatore monocomando esterno doccia, interasse 100 mm, senza kit doccia.



I 65 B

Miscelatore incasso per shut-off su piastra in ottone cromato, attacco conico da 1/2" e supporto shut-off.

DREAM

ATMOS

CLASS LINE

WINNER



IC31 REW

Miscelatore monocomando esterno doccia, interasse 100 mm e kit composto da doccia a pulsante art 332OW, flessibile conico 120 cm e supporto art. 339SO in ottone cromato.



I 60 W

Set miscelatore incasso shut-off comprensivo di: doccetta shut-off art. 332OW, supporto doccia-presa acqua, tutto in ottone cromato e flessibile doccia cm 120.



I 65 W

Miscelatore incasso per shut-off serie Infinity comprensivo di doccetta shut-off art. 332OW, supporto doccia-presa acqua, attacco conico da 1/2" e supporto shut-off, tutto in ottone cromato, flessibile doccia cm 120.

VASCA



I 02

Miscelatore vasca esterno con flessibile cm 150 e doccetta con getti in silicone anticalcare ovale.



I 05

Miscelatore vasca esterno senza kit doccia.



I 08

Miscelatore bordo vasca da pavimento, con deviatore e kit doccia in ottone cromato. Altezza 900 mm, Interasse 180 mm.

## INFINITY

## INFINITY

*La serie di miscelatori monocomando Infinity nasce da un'idea di design in cui la resa estetica di leggerezza del prodotto ricopre un ruolo di primaria importanza.*

*La morbidezza del corpo ed i suoi raggi addolciti sono interrotti in corrispondenza della bocca di erogazione e della leva, entrambe caratterizzate dallo stesso profilo, estremamente assottigliate e con una superficie superiore completamente piana.*

*Questo design dona alla serie un grande slancio ed ogni singolo prodotto visto nella sua globalità comunica grande personalità ed è autentica espressione di moderna eleganza.*

*Il design della serie è stato ideato dal designer Cristian Mapelli, parte del Dipartimento di Ricerca e Sviluppo del Gruppo Remer ed ingegnerizzata e prodotta nei nostri stabilimenti produttivi situati in provincia di Milano.*







VANITY

INFINITY

DREAM

ATMOS

CLASS LINE

WINNER

## VASCA



**I 07**

Miscelatore monocomando bordo vasca con deviatore a leva integrato nella bocca minimale e doccetta estraibile anticalcare.



**I 07 UF**

Miscelatore monocomando bordo vasca con deviatore integrato nel miscelatore, bocca a cascata e doccetta anticalcare.



**I 06**

Miscelatore monocomando bordo vasca con deviatore, bocca con effetto multigetto e doccetta estraibile cromata.



**I 27**

Miscelatore bordo vasca con deviatore integrato nel miscelatore e doccetta minimale estraibile.



**I 49**

Miscelatore lavabo/vasca con canna fusa lunga 30 cm e deviatore con kit doccia.



**I 46**

Miscelatore lavabo/vasca con canna fusa lunga 30 cm e deviatore senza kit doccia.

## DOCCE



**I 38**

Miscelatore doccia esterno con leva frontale e kit doccia.



**I 39**

Miscelatore doccia esterno con kit doccia.



**I 33**

Miscelatore doccia esterno con leva frontale, senza kit doccia.



**I 31**

Miscelatore doccia esterno senza kit doccia.



**317V 317RV**

Saliscendi cromato con asta minimale ovale dritta e doccetta con getti in silicone anticalcare ovale.

COLONNE DOCCIA

I 35

Gruppo doccia a muro minimale con attacco superiore da 3/4".



NEW

I 34

Miscelatore vasca/doccia serie Infinity con attacco superiore da 1/2" ed attacco inferiore da 1/2".



NEW

I 34 34

Miscelatore vasca/doccia serie Infinity con attacco superiore da 3/4" ed attacco inferiore da 1/2".



I 34A7RV54QI

Miscelatore vasca/doccia art. I 34 34 con attacco superiore da 3/4" ed attacco inferiore da 1/2", colonna doccia telescopica, doccetta anticalcare a 1 funzione, con flessibile 333 CNX 150 cm e soffione quadrato con angoli arrotondati ultrapiatto in ABS cromato 20x20 cm, con getti in silicone autopulenti ed anticalcare.

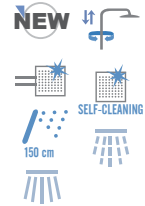

I 37A7RV54QI

Miscelatore doccia art. I 35 con attacco superiore da 3/4", colonna doccia telescopica, doccetta anticalcare a 1 funzione con deviatore, flessibile 333 CNX 150 cm e soffione quadrato con angoli arrotondati ultrapiatto in ABS cromato 20x20 cm, con getti in silicone autopulenti ed anticalcare.

VANITY

INFINITY

DREAM

ATMOS

BOCCHIE ED INCASSI

91 I

Bocca incasso cm 18.



I 30

Monocomando doccia incasso con piastra in lastra di ottone cromato.



L 30 B

Parte interna miscelatore monocomando incasso doccia.

I 30 E

Parte esterna miscelatore monocomando incasso doccia.

I 09

Monocomando vasca/doccia incasso con deviatore e con piastra in lastra di ottone cromato.



L 09 B

Parte interna miscelatore monocomando incasso vasca/doccia con deviatore.

I 09 E

Parte esterna miscelatore monocomando incasso vasca/doccia con deviatore.

I 92

Miscelatore monocomando per doccia, con deviatore a due posizioni (due uscite ed una entrata) su piastra unica.



I 93

Miscelatore monocomando per doccia con deviatore a tre vie (una entrata e tre uscite) su unica piastra.



I 93 7

Miscelatore monocomando per doccia con deviatore a tre vie e sette posizioni (una entrata, tre uscite e sette posizioni con cui selezionare uscite singole o miscelate tra loro) su unica piastra.

I 94

Miscelatore monocomando per doccia, con deviatore a 4 posizioni (4 uscite ed 1 entrata) su piastra unica.



NEW

I 95

Miscelatore monocomando per doccia, con deviatore a 5 posizioni (5 uscite ed una entrata) su piastra unica.

CLASS LINE

WINNER

## BOX INCASSO



**NEW**

### RR BOX

Box da incasso per miscelatore doccia con deviatore.



### I 30 KB

Set miscelatore doccia da abbinare al box incasso.



**NEW**

### RR BOX

Box da incasso per miscelatore doccia con deviatore.



### I 09 KB

Set miscelatore doccia con deviatore da abbinare al box incasso.



**NEW**

### RR BOX 93

Box da incasso per miscelatore doccia tre vie.



### I 93 KB

Set miscelatore doccia tre vie da abbinare al box incasso.



**NEW**

### RR BOX 92

Box da incasso per miscelatore doccia due vie.



### I 92 KB

Set miscelatore doccia due vie da abbinare al box incasso.



**NEW**

### RR BOX 93

Box da incasso per miscelatore doccia tre vie.



### I 93 7 KB

Set miscelatore doccia tre vie e sette posizioni da abbinare al box incasso.

## WELLNESS



### I09 S01

Set doccia composto da:

Art. 348S 354QI: soffione doccia cm 20x20 quadrato con angoli arrotondati ultrapiatto in abs cromato, e getti anticalcare con braccio quadrato in ottone cm 30.  
Art. 109: Monocomando vasca/doccia incasso con deviatore.

Art. 317V 317RV 333CN 150: saliscendi cromato con asta minimale ovale dritta, doccetta anticalcare e flessibile conico in ottone cromato cm 150.

Art. 309S: presa acqua quadrata in ottone cromato.



### I09 S02

Set doccia composto da:

Art. 348S 354QI: soffione doccia cm 20x20 quadrato con angoli arrotondati ultrapiatto in abs cromato, e getti anticalcare con braccio quadrato in ottone cm 30.  
Art. 109: Monocomando vasca/doccia incasso con deviatore.

Art. 339SOS: supporto fisso quadrato in ottone cromato per flessibile con attacco conico.

Art. 317RV 333CN 150: doccetta cromata minimale ovale anticalcare con flessibile conico in ottone cromato cm 150.  
Art. 309S: presa acqua quadrata in ottone cromato.



### I09 S01 UFD20

Set doccia composto da:

Art. 348S 357UFD: soffione doccia cm 20x20 quadrato con angoli arrotondati ultrapiatto in acciaio INOX lucidato a specchio, e getti anticalcare con braccio quadrato in ottone cm 30.  
Art. 109: Monocomando vasca/doccia incasso con deviatore.

Art. 317V 317RV 333CN 150: saliscendi cromato con asta minimale ovale dritta, doccetta anticalcare e flessibile conico in ottone cromato cm 150.  
Art. 309S: presa acqua quadrata in ottone cromato.

CUCINA



**I 72**  
Miscelatore monocomando monoforo 90°, con canna alta a "U" girevole.



**I 72 C**  
Miscelatore monocomando per lavello, con canna corta girevole, tipo lusso.



**I 42 R**  
Miscelatore monocomando monoforo 90° per lavello, con bocca alta girevole ed orientabile, tipo lusso, modello sottofinestra.



**I 42 B**  
Miscelatore monocomando per lavello, con bocca alta girevole.



**I 42 BC**  
Miscelatore monocomando per lavello, con canna corta girevole.



**I 533**  
Miscelatore lavello monocomando con flessibile nero rivestito con molla "fine design" girevole 360°, con doccetta estraibile di supporto ed orientabile a due funzioni e cartuccia Ø 35.



**I 77 E**  
Miscelatore monocomando lavello a molla con doccetta estraibile dal supporto ed orientabile a due funzioni e cartuccia Ø 35.



**I 41**  
Miscelatore monocomando per lavello a muro, canna dritta lunga 20 cm.



**I 41 S**  
Miscelatore monocomando per lavello a muro, con bocca a "S" lunga 21 cm.

VANITY

INFINITY

DREAM

ATMOS

CLASS LINE

WINNER

ACQUA PURIFICATA



**I 79 DW**  
Miscelatore lavello serie Winner a tre vie di ingresso con bocca girevole e due vie d'uscita completamente indipendenti, con selezione acqua potabile tramite la leva.

TOUCH-ME



**IT 72**  
Miscelatore monocomando lavello, monoforo 90° con canna alta ad "U" dotata di tecnologia Touch-Me con leva laterale e bocca girevole. Dotato di cartuccia Ø35.

# DREAM

## CARATTERISTICHE TECNICHE:

La serie è dotata di cartuccia a dischi ceramici, Ø 35 mm, prodotta da S.T.S.R. – Studio Tecnico Sviluppo e Ricerche - [www.stsr.it](http://www.stsr.it)



VANITY

INFINITY

DREAM

ATMOS

GLASS LINE

WINNER





### SIMBOLOGIE:

										
Con scarico con troppo pieno	Senza scarico	Con Click-Clack con Troppo Pieno	Proporzione perfetta.	Prodotto novità	Doccetta Anticalcare	Lavello sottofinestra con canna girevole	Canna alta girevole	Canna girevole	Doccetta estraibile	Doccetta orientabile
										
Acqua Potabile	Colonna doccia girevole e telescopica.	Con Kit Doccia e flessibile lungo: 120, 150 o 200 cm	Soffione Anticalcare ed Autopulente	Con getto a cascata.	Con multigetto.	Getto con massaggio intenso a risparmio idrico	Getto aerato intenso	Getto Esterno	Massaggio con getto vigoroso concentrato	Getto spray delicato ad ampia copertura con getto vigoroso all'esterno a risparmio idrico

## LAVABI





LAVABO BOX INCASSO

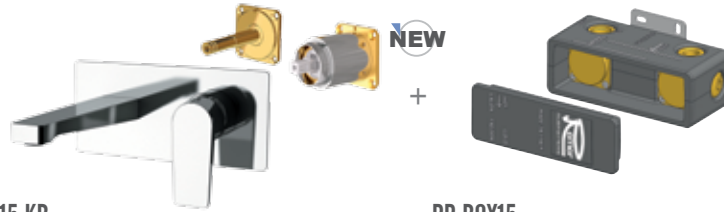

**D 15 KB**  
Miscelatore monocomando a incasso per lavabo, con piastra in ottone cromato da abbinare al box incasso.

**RR BOX15**  
Box da incasso per miscelatore monocomando a incasso per lavabo.

VANITY

INFINITY

BIDET



**D 20**  
Miscelatore monocomando bidet.



**D 65 W**  
Miscelatore incasso per shut-off comprensivo di doccetta shut-off art. 332OW,, supporto doccia-presa acqua, attacco conico da 1/2" e supporto shut-off, tutto in ottone cromato, flessibile doccia cm 120.



**D 60 W**  
Miscelatore incasso per shut-off comprensivo di doccetta shut-off art. 332OW, supporto doccia-presa acqua su piastra in ottone cromato e flessibile doccia cm 120.



**D 21**  
Miscelatore monocomando bidet.



**D 65 B**  
Miscelatore incasso per shut-off su piastra in ottone cromato, attacco conico da 1/2" e supporto shut-off.

DREAM

ATMOS

CLASS LINE

VASCA



**D 02**  
Miscelatore vasca esterno con kit doccia, doccetta a 4 funzioni.



**D 05**  
Miscelatore vasca esterno senza set doccia.



**D 07**  
Miscelatore monocomando bordo vasca con deviatore a leva integrato nella bocca minimale e doccetta in ABS cromato a 4 funzioni.



**D 06**  
Miscelatore monocomando bordo vasca con deviatore, bocca con effetto multigetto e doccetta estraibile in ABS a 4 funzioni.



**D 07 UF**  
Miscelatore monocomando bordo vasca con deviatore integrato nel miscelatore, bocca a cascata e doccetta estraibile in ABS cromato a 4 funzioni.



**DC 06**  
Miscelatore monocomando bordo vasca con deviatore, bocca con effetto cascata e doccetta estraibile in ABS a 4 funzioni.

WINNER

## DREAM

## DREAM

*Dream è l'espressione di un design chiaro e pulito, attento ai dettagli che fanno la differenza tra un prodotto normale ed uno di successo.*

*Gli amanti dei particolari noteranno sicuramente che il corpo è sviluppato da una forma ellittica che sale verso l'alto con uno sforno esterno; in questo modo abbiamo eliminato esteticamente il raggio di giunzione tra corpo e bocca.*

*Quest'ultima è estremamente sottile e rastremata verso l'aeratore invisibile. La basetta ultra piatta di 2 mm è un particolare dal carattere moderno e hi-tech.*

*L'insieme di questi fattori donano eleganza e armoniosità al prodotto.*

*Dream in sostanza è un sogno, il sogno di avere una rubinetteria dal design raffinato ad un costo ragionevole.*

*Il design della serie è stato ideato dal designer Cristian Mapelli, parte del Dipartimento di Ricerca e Sviluppo del Gruppo Remer ed ingegnerizzata e prodotta nei nostri stabilimenti produttivi situati in provincia di Milano.*

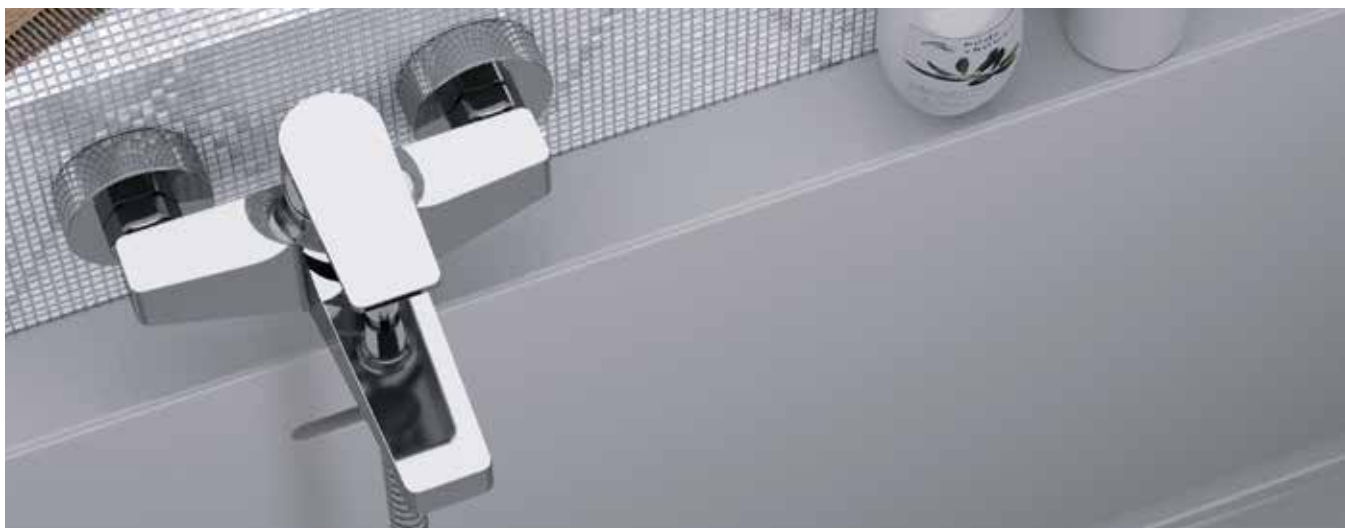



VANITY

INFINITY

**DREAM**

ATMOS

CLASS LINE

WINNER

## BOCCHIE ED INCASSI



**91 DR**  
Bocca incasso cm 18.



**D 30**  
Monocomando doccia incasso con piastra in lastra di ottone cromato.



**D 09**  
Monocomando vasca/doccia incasso con deviatore e con piastra in lastra di ottone cromato.

**L 30 B**  
Parte interna miscelatore monocomando incasso doccia.

**L 09 B**  
Parte interna miscelatore monocomando incasso vasca/doccia con deviatore.

**D 30 E**  
Parte esterna miscelatore monocomando incasso doccia.

**D 09 E**  
Parte esterna miscelatore monocomando incasso vasca/doccia con deviatore.



**D 92**  
Miscelatore monocomando per doccia, con deviatore a due posizioni (due uscite ed una entrata) su piastra unica.



**D 93**  
Miscelatore monocomando per doccia con deviatore a tre vie (una entrata e tre uscite) su unica piastra.



**D 94**  
Miscelatore monocomando per doccia, con deviatore a 4 posizioni (4 uscite ed 1 entrata) su piastra unica.

**NEW**

**D 93 7**  
Miscelatore monocomando per doccia con deviatore a tre vie e sette posizioni (una entrata, tre uscite e sette posizioni con cui selezionare uscite singole o miscelate tra loro) su unica piastra.

**D 95**  
Miscelatore monocomando per doccia, con deviatore a 5 posizioni (5 uscite ed una entrata) su piastra unica.

## BOX INCASSO



**RR BOX**  
Box da incasso per miscelatore doccia con deviatore.

**NEW**



**D 30 KB**  
Set miscelatore doccia da abbinare al box incasso.



**RR BOX**  
Box da incasso per miscelatore doccia con deviatore.



**D 09 KB**  
Set miscelatore doccia con deviatore da abbinare al box incasso.



**RR BOX 93**  
Box da incasso per miscelatore doccia tre vie.

**NEW**



**D 93 KB**  
Set miscelatore doccia tre vie da abbinare al box incasso.



**RR BOX 92**  
Box da incasso per miscelatore doccia due vie.

**NEW**



**D 92 KB**  
Set miscelatore doccia due vie da abbinare al box incasso.



**RR BOX 93**

Box da incasso per miscelatore doccia tre vie.

**D 93 7 KB**

Set miscelatore doccia tre vie e sette posizioni da abbinare al box incasso.

VANITY

INFINITY

DREAM

ATMOS

CLASS LINE

WINNER

DOCCE



**D 38**

Miscelatore doccia esterno con kit doccia, doccetta a 4 funzioni.



**D 33**

Miscelatore doccia esterno senza kit doccia.



**317Q 319M0**

Saliscendi in ottone cromato con asta ultrapiatta rettangolare e doccetta cromata minimale a 4 funzioni con getti in silicone, idromassaggio ed anticalcare.

COLONNE DOCCIA



**D 35**

Gruppo doccia a muro minimale con attacco superiore da 3/4".



**D 34**

Miscelatore vasca/doccia serie Dream con attacco superiore da 1/2" ed attacco inferiore da 1/2".

**D 34 34**

Miscelatore vasca/doccia serie Dream con attacco superiore da 3/4" ed attacco inferiore da 1/2".



**D 34 AUFD25**

Miscelatore vasca/doccia serie Dream con attacco superiore da 3/4" ed attacco inferiore da 1/2", con colonna doccia telescopica, doccetta anticalcare a 4 funzioni, con flessibile 333 CNX 150 cm e soffione doccia quadrato con angoli arrotondati ultrapiatto in acciaio INOX 25x25 cm, Art. 357 UF S20 lucidato a specchio con getti in silicone anticalcare.



**D 37 AAD20**

Miscelatore doccia serie Dream con attacco da 3/4", con colonna doccia telescopica, doccetta anticalcare a 4 funzioni, con flessibile 333 CNX 150 cm e soffione a pioggia squadrato con angoli arrotondati, in ABS cromato Art. 356 AD 20, 20x20 cm, con getti in silicone anticalcare.



## WELLNESS



Set doccia composto da:  
 Art. 357UFD 348N: Soffione doccia ultra piatto in acciaio INOX lucidato a specchio con braccio in ottone.  
 Art. 315R 319MO con 333CN150: Saliscendi cromato con asta tonda minimale e doccetta cromata minimale a 4 funzioni con getti in silicone, idromassaggio ed anticalcare e flessibile conico in ottone cromato.  
 Art. 309 L: presa acqua tipo rotondo pesante.  
 Art. D 09: Miscelatore incasso con deviatore.



CODICE	DESCRIZIONE
D 09 S01 UFD20	Con 357UFD20: Soffione doccia ultra piatto 20x20 cm, braccio doccia 30 cm.
D 09 S01 UFD25	Con 357UFD25: Soffione doccia ultra piatto 25x25 cm, braccio doccia 30 cm.
D 09 S01 UFD30	Con 357UFD30: Soffione doccia ultra piatto 30x30 cm, braccio doccia 30 cm.
D 09 S01 UFD40	Con 357UFD40: Soffione doccia ultra piatto 40x40 cm, braccio doccia 40 cm.



Set doccia composto da:  
 Art. 357UFD 348N: Soffione doccia ultra piatto in acciaio INOX lucidato a specchio con braccio in ottone.  
 Art. 339N 319MO con 333CN150: doccetta cromata minimale a 4 funzioni con getti in silicone, idromassaggio ed anticalcare, supporto snodato a braccio minimale in abs cromato e flessibile conico in ottone cromato.  
 Art. 309 L: presa acqua tipo rotondo pesante.  
 Art. D 09: Miscelatore incasso con deviatore.



CODICE	DESCRIZIONE
D 09 S02 UFD20	Con 357UFD20: Soffione doccia ultra piatto 20x20 cm, braccio doccia 30 cm.
D 09 S02 UFD25	Con 357UFD25: Soffione doccia ultra piatto 25x25 cm, braccio doccia 30 cm.
D 09 S02 UFD30	Con 357UFD30: Soffione doccia ultra piatto 30x30 cm, braccio doccia 30 cm.
D 09 S02 UFD40	Con 357UFD40: Soffione doccia ultra piatto 40x40 cm, braccio doccia 40 cm.

## CUCINA



**D 72**

Miscelatore monocomando monoforo 90°, con canna alta a "U" girevole.



**D 72 C**

Miscelatore monocomando per lavello, con canna corta a "U" girevole, tipo lusso.



**D 42 R**

Miscelatore monocomando monoforo 90° per lavello, con bocca alta girevole ed orientabile, tipo lusso, modello sottofinestra.



**D 42 B**

Miscelatore monocomando per lavello, con bocca alta girevole.



**D 42 BC**

Miscelatore monocomando per lavello, con bocca corta girevole.



**D 77 E**

Miscelatore monocomando lavello a molla con doccetta estraibile dal supporto ed orientabile a due funzioni e cartuccia Ø 35.



VANITY

INFINITY

DREAM

ATMOS

CLASS LINE

WINNER

ACQUA PURIFICATA

TOUCH-ME

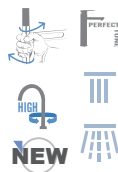

D 533

Miscelatore lavello monocomando con flessibile nero rivestito con molla "fine design" girevole 360°, con doccetta estraibile di supporto ed orientabile a due funzioni e cartuccia Ø 35.



D 79 DW

Miscelatore lavello a tre vie di ingresso con bocca girevole e due vie d'uscita completamente indipendenti, con selezione acqua potabile tramite la leva.



DT 72

Miscelatore monocomando lavello, monoforo 90° con canna alta ad "U" dotata di tecnologia Touch-Me con leva laterale e bocca girevole. Dotato di cartuccia Ø35.

# ATMOS

## CARATTERISTICHE TECNICHE:

La serie è dotata di cartuccia a dischi ceramici, Ø 40 mm, tranne art. A 40 e art. A 10 L dotati di cartuccia Ø 35 mm, prodotte da S.T.S.R. – Studio Tecnico Sviluppo e Ricerche - [www.stsr.it](http://www.stsr.it)  
Finiture disponibili: cromo, bianco opaco, nero opaco.

VANITY

INFINITY

DREAM

ATMOS

CLASS LINE

WINNER





**SIMBOLOGIE:**

- |   |   |   |   |   |   |   |   |   |   |   |
|---|---|---|---|---|---|---|---|---|---|---|
|  |  |  |  |  |  |  |  |  |  |  |
| Con scarico con troppo pieno  | Senza scarico   | Con Click-Clack   | Con Click-Clack con Troppo Pieno  | Proporzione perfetta.   | Con Kit Doccia e flessibile lungo: 120, 150 o 200 cm                              | Doccetta Anticalcare  | Getto ad ampia copertura effetto pioggia  | Ampio getto pioggia a risparmio idrico  | Soffione Autopulente  | Corpo girevole  |
| CR = cromato  |   |   | BO = bianco opaco   |   |   | NO = nero opaco   |   |   |   |   |

**LAVABI E BIDET**



**A 10**  
Miscelatore monocomando lavabo.  
Altezza 135 mm, interasse 172 mm.



**A 11**  
Miscelatore monocomando lavabo senza scarico.  
Altezza 135 mm, interasse 172 mm.



**A 10 L**  
Miscelatore monocomando lavabo alto L con scarico click-clack.  
Altezza 229 mm, interasse 210 mm.



**A 10 LB**  
Miscelatore monocomando alto per lavabo, con scarico click-clack senza troppo pieno.  
Altezza 229 mm, interasse 210 mm.



**A 11 L**  
Miscelatore monocomando alto per lavabo, senza scarico.  
Altezza 229 mm, interasse 210 mm.



**A 20**  
Miscelatore monocomando bidet, con aeratore direzionabile coperto e schermato.



**A 21**  
Miscelatore monocomando bidet, con aeratore direzionabile coperto e schermato senza scarico.



VASCA



**A 02**

Miscelatore monocomando vasca, esterno, con rosone ad arco "full cover" e con set doccia duplex "torch".



**A 05**

Miscelatore monocomando vasca, esterno, con rosone ad arco "full cover" senza set doccia.

VANITY

INFINITY

DOCCE



**A 38**

Miscelatore monocomando esterno doccia con leva frontale, con rosone ad arco "full cover" e con set doccia duplex "torch".



**A 33**

Miscelatore monocomando esterno doccia con leva frontale e con rosone ad arco "full cover" senza set doccia.

DREAM

ATMOS

CLASS LINE

INCASSI



**A 30**

Miscelatore monocomando da incasso senza deviatore.

**N 30 B**

Parte interna miscelatore monocomando incasso doccia.

**A 30 E**

Parte esterna miscelatore monocomando incasso doccia.



**A 09**

Miscelatore monocomando da incasso con deviatore per vasca/doccia.

**N 09 B**

Parte interna miscelatore monocomando incasso vasca/doccia con deviatore.

**A 09 E**

Parte esterna miscelatore monocomando incasso vasca/doccia con deviatore.



**A 30 V**

Miscelatore monocomando da incasso senza deviatore.

**N 30 B**

Parte interna miscelatore monocomando incasso doccia.

**A 30 VE**

Parte esterna miscelatore monocomando incasso doccia.



**A 09 V**

Miscelatore monocomando da incasso con deviatore per vasca/doccia.

**N 09 B**

Parte interna miscelatore monocomando incasso vasca/doccia con deviatore.

**A 09 VE**

Parte esterna miscelatore monocomando incasso vasca/doccia con deviatore.

WINNER



**A 92**

Miscelatore monocomando per doccia, con deviatore a due posizioni (due uscite ed una entrata) su piastra unica.



**A 93**

Miscelatore monocomando per doccia con deviatore a tre vie (una entrata e tre uscite) su unica piastra.



**A 93 7**

Miscelatore monocomando per doccia con deviatore a tre vie e sette posizioni (una entrata, tre uscite e sette posizioni con cui selezionare uscite singole o miscelate tra loro) su unica piastra.

**BOX INCASSO**



**RR BOX**

Box da incasso per miscelatore doccia con deviatore.

+



**A 30 KB**

Set miscelatore doccia da abbinare al box incasso.



**RR BOX**

Box da incasso per miscelatore doccia con deviatore.

+

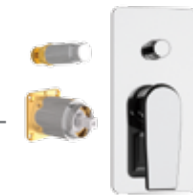

**A 09 KB**

Set miscelatore doccia con deviatore da abbinare al box incasso.



**RR BOX93**

Box da incasso per miscelatore doccia tre vie.

NEW



**A 93 KB**

Set miscelatore doccia tre vie da abbinare al box incasso.



**RR BOX92**

Box da incasso per miscelatore doccia due vie.

NEW



**A 92 KB**

Set miscelatore doccia due vie da abbinare al box incasso.



**RR BOX93**

Box da incasso per miscelatore doccia tre vie.

NEW



**A 93 7 KB**

Set miscelatore doccia tre vie e sette posizioni da abbinare al box incasso.

WELLNESS



A 09V S02

Art. 348N30 + 359MM30: braccio doccia in ottone cromato con soffione minimale in ottone cromato anticalcare Ø 30.  
 Art. 317TH 339: doccetta Torch in abs cromato con supporto snodato e flessibile conico in ottone cromato cm 150.  
 Art. 309 L: presa acqua deluxe in ottone cromato.  
 Art. A 09 V: Miscelatore incasso doccia con deviatore.



A 09V S07

Art. 348N30 + 359MM30: braccio doccia in ottone cromato con soffione minimale in ottone cromato anticalcare Ø 30.  
 Art. 310M 317TH: saliscendi con doccetta Torch e flessibile conico in ottone cromato cm 150.  
 Art. 309 L: presa acqua deluxe in ottone cromato.  
 Art. A 09 V: Miscelatore incasso doccia con deviatore.



A 09 S02

Art. 348N30 + 359MM30: braccio doccia in ottone cromato con soffione minimale in ottone cromato anticalcare Ø 30.  
 Art. 317TH 339: doccetta Torch in abs cromato con supporto snodato e flessibile conico in ottone cromato cm 150.  
 Art. 309 L: presa acqua deluxe in ottone cromato.  
 Art. A 09: Miscelatore incasso doccia con deviatore.



A 09 S07

Art. 348N30 + 359MM30: braccio doccia in ottone cromato con soffione minimale in ottone cromato anticalcare Ø 30.  
 Art. 310M 317TH: saliscendi con doccetta Torch e flessibile conico in ottone cromato cm 150.  
 Art. 309 L: presa acqua deluxe in ottone cromato.  
 Art. A 09: Miscelatore incasso doccia con deviatore.

VANITY

INFINITY

DREAM

ATMOS

CLASS LINE

WINNER

CUCINA



A 40

Monocomando lavello con corpo girevole.

# CLASS LINE

## CARATTERISTICHE TECNICHE:

La serie è dotata di cartuccia a dischi ceramici, Ø 35 mm, prodotta da S.T.S.R. – Studio Tecnico Sviluppo e Ricerche - [www.stsr.it](http://www.stsr.it)

# EASY CONTEMPORARY

VANITY

INFINITY

DREAM

ATMOS

CLASS LINE

WINNER





**SIMBOLOGIE:**

-  Con scarico con troppo pieno
-  Senza scarico
-  Con scarico in plastica
-  Con Click-Clack con Troppo Pieno
-  Proporzione perfetta.
-  Con Kit Doccia e flessibile lungo: 120, 150 o 200 cm
-  Doccetta Anticalcare
-  Lavello sottofinestra con canna girevole
-  Canna alta girevole
-  Canna girevole
-  Doccetta estraibile
-  Doccetta orientabile
-  Acqua Potabile
-  Prodotto novità
-  Colonna doccia girevole e telescopica.
-  Soffione Anticalcare ed Autopulente
-  Con Batterie al Litio Include
-  Touch-Me
-  Con multigetto.
-  Con getto a cascata.
-  Getto con massaggio intenso a risparmio idrico
-  Getto aerato intenso
-  Getto Esterno
-  Massaggio con getto vigoroso concentrato
-  Getto spray delicato ad ampia copertura con getto vigoroso all'esterno a risparmio idrico
-  Getto ad ampia copertura effetto pioggia



**LAVABI**



**L 10**  
Miscelatore monocomando lavabo.  
Altezza 150 mm, interasse 110 mm.

**L 10 P**  
Miscelatore monocomando lavabo con scarico in plastica.  
Altezza 150 mm, interasse 110 mm.



**L 10 L**  
Miscelatore monocomando lavabo alto L.  
Altezza 170 mm, interasse 130 mm.



**L 10 LXL**  
Miscelatore monocomando lavabo alto XL con scarico click-clack.  
Altezza 306 mm, interasse 180 mm.



**L 11**  
Miscelatore monocomando lavabo senza scarico.  
Altezza 150 mm, interasse 110 mm.



**L 11 L**  
Miscelatore monocomando lavabo alto L senza scarico.  
Altezza 170 mm, interasse 130 mm.



**L 11 LXL**  
Miscelatore monocomando lavabo alto XL senza scarico.  
Altezza 306 mm, interasse 180 mm.

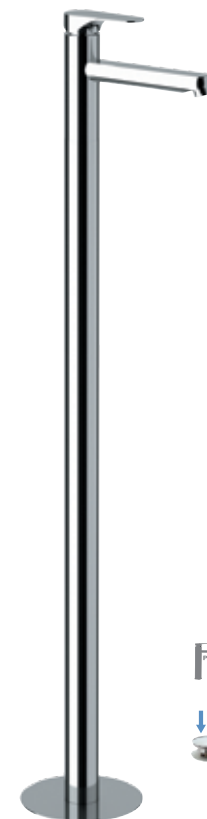

**L 18**  
Miscelatore monocomando lavabo da terra con scarico click-clack.  
Altezza 1020 mm, interasse 187 mm.



**L 57**  
Miscelatore monocomando lavello due fori senza scarico.



**L 15**  
Miscelatore monocomando a incasso per lavabo, con piastra rettangolare in ottone cromato e bocca lunghezza cm 18.



**L 14**  
Miscelatore monocomando a incasso per lavabo, con piastra verticale in ottone cromato e bocca lunghezza cm 18.

## LAVABO BOX INCASSO



**L 15 KB**

Miscelatore monocomando a incasso per lavabo, con piastra in ottone cromato da abbinare al box incasso.

**RR BOX 15**

Box da incasso per miscelatore monocomando a incasso per lavabo.

VANITY

INFINITY

## BIDET

DREAM

ATMOS

CLASS LINE

WINNER



**L 20**

Miscelatore monocomando bidet.



**L 20 P**

Miscelatore monocomando bidet con scarico in plastica.



**L 21**

Miscelatore monocomando bidet senza scarico.



**L 10 SHW**

Miscelatore monocomando lavabo con doccetta shut-off 332OW e scarico click-clack e troppo pieno.



**L 65 W**

Miscelatore incasso per shut-off comprensivo di doccetta shut-off art. 332OW, supporto doccia-presa acqua, attacco conico da 1/2" e supporto shut-off, tutto in ottone cromato, flessibile doccia cm 120.



**L 65 B**

Miscelatore incasso per shut-off su piastra in ottone cromato, attacco conico da 1/2" e supporto shut-off.



**L 60 W**

Set miscelatore incasso shut-off con flessibile doccia cm 120.



**LC 31 DP**

Miscelatore monocomando esterno doccia, interasse 100 mm, con kit.



**LC 31**

Miscelatore monocomando esterno doccia, interasse 100 mm.



**L 63**

Miscelatore incasso per shut-off.

## VASCA



**L 02**  
Miscelatore vasca esterno con flessibile cm 150 e doccia duplex a 4 funzioni.



**L 03**  
Miscelatore monocomando per vasca, con deviatore integrato e kit doccia con doccetta a 4 funzioni.



**L 05**  
Miscelatore vasca esterno senza set doccia.



**L 04**  
Miscelatore monocomando per vasca, con deviatore integrato.



**L 08**  
Miscelatore bordo vasca da pavimento, con deviatore e kit doccia in ottone cromato, senza scarico. Altezza 92,7cm, interasse 20,1 cm.



**L 06**  
Miscelatore monocomando bordo vasca con deviatore, bocca con effetto multigetto e doccetta cromata estraibile a 4 funzioni.



**L 07**  
Miscelatore monocomando bordo vasca con deviatore a leva integrato nella bocca minimale in ottone cromato e doccetta cromata estraibile a 4 funzioni.



**L 07 UF**  
Miscelatore monocomando bordo vasca con deviatore integrato nel miscelatore, bocca a cascata e doccetta cromata estraibile a 4 funzioni.



**L 49**  
Miscelatore lavabo/vasca con canna fusa lunga, deviatore e kit doccia con doccetta minimale a 4 funzioni, canna lunghezza 30 cm.



**L 46**  
Miscelatore lavabo/vasca con canna fusa lunga e deviatore senza kit doccia, con canna lunghezza 30 cm.

DOCCE



**L 39**  
Miscelatore doccia esterno con kit doccia e doccetta a 4 funzioni.



**L 31**  
Miscelatore doccia esterno senza kit doccia.



**317M 319MO**  
Saliscendi minimale con doccetta con idromassaggio a 4 funzioni.



**315L 318MP**  
Saliscendi minimale con doccetta a 4 funzioni con pulsante per il cambio getti, anticalcare.

VANITY

INFINITY

DREAM

ATMOS

COLONNE DOCCIA



**NEW**

**L 35**  
Gruppo doccia a muro minimale con attacco superiore da 3/4".



**NEW**

**L 34**  
Miscelatore vasca/doccia con attacco superiore da 1/2" ed attacco inferiore da 1/2".

**L 34 34**  
Miscelatore vasca/doccia con attacco superiore da 3/4" ed attacco inferiore da 1/2".



**L34 AMD25**  
Miscelatore vasca/doccia con attacco superiore da 3/4" ed attacco inferiore da 1/2", con colonna doccia telescopica, doccetta anticalcare a 4 funzioni, con flessibile 333 CNX 150 cm e soffione minimale Ø25 cm, in ABS lusso cromato, con getti in silicone anticalcare.



**L37 AMD20**  
Miscelatore doccia con attacco da 3/4", con colonna doccia telescopica, doccetta anticalcare a 4 funzioni, con flessibile 333 CNX 150 cm e soffione a pioggia in ABS cromato, Ø 20 cm, con getti in silicone anticalcare.

CLASS LINE

WINNER

## CLASS LINE

## CLASS LINE

*Class line è una serie di miscelatori ideata da Remer per arredare tutti gli spazi bagno in cui l'interesse della clientela punta ad una linea dal design moderno mantenendo tutti i confort e dei miscelatori di tipo classico.*

*Il design della serie gioca sul parallelismo tra leva e bocca di erogazione rendendo le superfici completamente piatte e riflettenti per poi fonderle con raggiature più morbide, in una perfetta unione tra tondo e quadro.*

*La serie è dotata di molti elementi che ne qualificano la gamma per ampiezza di scelta. Le tre tipologie di lavabo, standard, alto e a colonna, l'uso del brevetto Remer per la protezione dell'aeratore bidet, l'elegante incasso lavabo e le linee molto ricercate del gruppo vasca e dell'esterno doccia, fanno di Class Line una serie completa che mette in evidenza caratteristiche tecniche e di design esemplari rimanendo comunque in una gamma molto competitiva.*

*Il design della serie è stato ideato dal designer Cristian Mapelli, parte del Dipartimento di Ricerca e Sviluppo del Gruppo Remer ed ingegnerizzata e prodotta nei nostri stabilimenti produttivi situati in provincia di Milano.*





EASY CONTEMPORARY



VANITY

INFINITY

DREAM

ATMOS

CLASS LINE

WINNER

## BOCCHIE ED INCASSI



**L 30**  
Monocomando doccia incasso.

**L 30 B**  
Parte interna miscelatore monocomando incasso doccia.

**L 30 E**  
Parte esterna miscelatore monocomando incasso doccia.



**L 09**  
Monocomando vasca/doccia incasso con deviatore.

**L 09 B**  
Parte interna miscelatore monocomando incasso vasca/doccia con deviatore.

**L 09 E**  
Parte esterna miscelatore monocomando incasso vasca/doccia con deviatore.



**L 30 L**  
Monocomando doccia incasso con piastra lusso Class Line.

**L 30 B**  
Parte interna miscelatore monocomando incasso doccia.

**L 30 LE**  
Parte esterna miscelatore monocomando incasso doccia, piastra lusso Class Line.



**L 09 L**  
Monocomando vasca/doccia incasso con deviatore con piastra lusso Class Line.

**L 09 B**  
Parte interna miscelatore monocomando incasso vasca/doccia con deviatore.

**L 09 LE**  
Parte esterna miscelatore monocomando incasso vasca/doccia con deviatore, piastra lusso Class Line.



**91 L**  
Bocca incasso cm 18.



**L 92**  
Miscelatore monocomando per doccia, con deviatore a due posizioni (due uscite ed una entrata) su piastra unica.



**L 93**  
Miscelatore monocomando per doccia con deviatore a tre vie (una entrata e tre uscite) su unica piastra.



**L 94**  
Miscelatore monocomando per doccia, con deviatore a 4 posizioni (4 uscite ed 1 entrata) su piastra unica.



**91 LD**  
Bocca incasso con deviatore integrato, 18 cm.

**L 93 7**  
Miscelatore monocomando per doccia con deviatore a tre vie e sette posizioni (una entrata, tre uscite e sette posizioni con cui selezionare uscite singole o miscelate tra loro) su unica piastra.

**L 95**  
Miscelatore monocomando per doccia, con deviatore a 5 posizioni (5 uscite ed una entrata) su piastra unica.

## BOX INCASSO



**RR BOX**  
Box da incasso per miscelatore doccia con deviatore.



**L 30 KB**  
Set miscelatore doccia da abbinare al box incasso.



**RR BOX**  
Box da incasso per miscelatore doccia con deviatore.

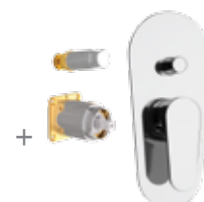

**L 09 KB**  
Set miscelatore doccia con deviatore da abbinare al box incasso.



**RR BOX 93**  
Box da incasso per miscelatore doccia tre vie.

**L 93 KB**  
Set miscelatore doccia tre vie da abbinare al box incasso.



**RR BOX 92**  
Box da incasso per miscelatore doccia due vie.

**L 92 KB**  
Set miscelatore doccia due vie da abbinare al box incasso.



**RR BOX 93**  
Box da incasso per miscelatore doccia tre vie.

**L 93 7 KB**  
Set miscelatore doccia tre vie e sette posizioni da abbinare al box incasso.

## WELLNESS



**L 09 S01**  
Set doccia composto da:  
Art. 356MD20 348N30: soffione minimale in abs lusso Ø 20 cm cromato con braccio in ottone cm 30.  
Art. L 09L: Monocomando vasca/doccia incasso con deviatore con piastra lusso.  
Art. 317M 319MO: saliscendi minimale con doccetta anticalcare a 4 funzioni.  
Art. 309L: presa acqua pesante e flessibile doccia cm 150.



**L 09 S02**  
Set doccia composto da:  
Art. 356MD20 348N30: soffione minimale in abs lusso Ø 20 cm cromato con braccio in ottone cm 30.  
Art. L 09L: Monocomando vasca/doccia incasso con deviatore, piastra lusso.  
Art. 319MO 337M: doccia duplex anticalcare a 4 funzioni con supporto presa acqua in ottone cromato e flessibile conico cm 150.



**L 09 S01 UFM20**  
Set doccia composto da:  
Art. 357UFM20 348N30: soffione minimale ultrapiatto in acciaio INOX lucidato a specchio Ø 20 cm con braccio in ottone cm 30.  
Art. L 09L: Monocomando vasca/doccia incasso con deviatore, piastra lusso.  
Art. 317M 319MO: saliscendi minimale con doccetta anticalcare a 4 funzioni.  
Art. 309L: presa acqua pesante e flessibile doccia cm 150.

VANITY

INFINITY

DREAM

ATMOS

CLASS LINE

WINNER

CUCINA



**L 72**  
Miscelatore monocomando monoforo 90°, con canna a "U" girevole.



**L 72 C**  
Miscelatore monocomando per lavello, con bocca corta girevole tipo lusso.



**L 77 E**  
Miscelatore monocomando lavello a molla con doccetta estraibile dal supporto ed orientabile a due funzioni e cartuccia Ø 35.

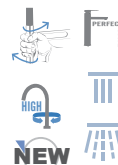

**L 42 B**  
Miscelatore monocomando per lavello, con bocca alta girevole.



**L 42 BC**  
Miscelatore monocomando per lavello, con bocca corta girevole.



**L 533**  
Miscelatore lavello monocomando con flessibile nero rivestito con molla "fine design" girevole 360°, con doccetta estraibile di supporto ed orientabile a due funzioni e cartuccia Ø 35.

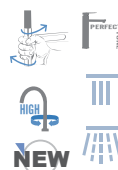

**L 42**  
Miscelatore monocomando per lavello, con bocca girevole tipo lusso.



**L 42 C**  
Miscelatore monocomando per lavello, con bocca corta girevole, tipo lusso a "C".



**L 42 U**  
Miscelatore monocomando per lavello, con bocca girevole a "U".



**L 42 R**  
Miscelatore monocomando monoforo 90° per lavello, con bocca alta girevole ed orientabile tipo lusso, modello sottofinestra.



**L 43**  
Miscelatore monocomando per lavello a muro, con leva frontale e bocca alta girevole.



**L 43 B**  
Miscelatore monocomando per lavello a muro, con leva frontale e bocca alta a "U" girevole.



**L 41**  
Miscelatore monocomando per lavello a muro, canna dritta lunghezza 20 cm.



**L 41 S**  
Miscelatore monocomando per lavello a muro, con bocca a "S" lunghezza 21 cm.



**L 40**  
Miscelatore monocomando per lavello, girevole.





VANITY

INFINITY

DREAM

ATMOS

CLASS LINE

WINNER

## TOUCH-ME



**LT 72**

Miscelatore monocomando lavello, monoforo 90° con canna alta a "U" dotata di tecnologia Touch-Me con leva laterale e bocca girevole. Dotato di cartuccia Ø35.



**LT 72 C**

Miscelatore monocomando lavello, monoforo 90° con canna corta ad "U" dotata di tecnologia Touch-Me con leva laterale e bocca girevole. Dotato di cartuccia Ø35.



**LT 72 U**

Miscelatore monocomando lavello, monoforo 90° con canna alta quadra a "U" dotata di tecnologia Touch-Me con leva laterale e bocca girevole. Dotato di cartuccia Ø35.

## ACQUA PURIFICATA



**L 79 DW**

Miscelatore lavello a tre vie di ingresso con bocca girevole e due vie d'uscita completamente indipendenti, con selezione acqua potabile tramite la leva.



# WINNER

## CARATTERISTICHE TECNICHE:

La serie è dotata di cartuccia a dischi ceramici, Ø 35 mm, prodotta da S.T.S.R. – Studio Tecnico Sviluppo e Ricerche - [www.stsr.it](http://www.stsr.it)

# EASY CONTEMPORARY

VANITY

INFINITY

DREAM

ATMOS

CLASS LINE

WINNER





## SIMBOLOGIE:



## LAVABI



**W 10**  
 Miscelatore monocomando lavabo.  
 Altezza 150 mm, interasse 107 mm.



### W 10 P

Miscelatore monocomando lavabo con scarico in plastica.  
 Altezza 150 mm, interasse 107 mm.



**W 11**  
 Miscelatore monocomando lavabo senza scarico.  
 Altezza 150 mm, interasse 107 mm.



### W 12

Miscelatore monocomando lavabo senza scarico e senza foro sul corpo.  
 Altezza 150 mm, interasse 107 mm.



**W 10L**  
 Miscelatore monocomando lavabo con scarico click-clack.  
 Altezza 305 mm, interasse 182 mm.



### W 11L

Miscelatore monocomando lavabo senza scarico.  
 Altezza 305 mm, interasse 182 mm.





**W 57**  
Miscelatore monocomando lavabo due fori, senza scarico.



**W 15**  
Miscelatore monocomando a incasso per lavabo, con piastra orizzontale in ottone cromato, lunghezza bocca 18 cm.



**W 14**  
Miscelatore monocomando a incasso per lavabo, con piastra verticale in ottone cromato, lunghezza bocca 18 cm.

VANITY

INFINITY

## LAVABO BOX INCASSO

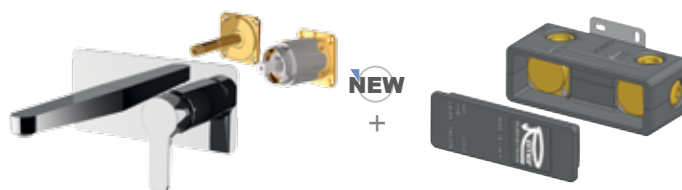

**W 15 KB**  
Miscelatore monocomando a incasso per lavabo, con piastra in ottone cromato da abbinare al box incasso.

**RR BOX15**  
Box da incasso per miscelatore monocomando a incasso per lavabo.

DREAM

ATMOS

## BIDET



**W 20**  
Miscelatore monocomando bidet.

**W 20 P**  
Miscelatore monocomando bidet con scarico in plastica.

PLASTIC



**W 60 W**  
Miscelatore incasso per shut-off comprensivo di: doccetta shut-off art. 332OW, supporto doccia-presa acqua su piastra in ottone cromato e flessibile doccia cm 120.



**W 65 W**  
Miscelatore incasso per shut-off comprensivo di: doccetta shut-off 332OW, supporto doccia-presa acqua, attacco conico da 1/2" e supporto shut-off, tutto in ottone cromato, flessibile doccia cm 120.



**WC 31 DP**  
Miscelatore monocomando esterno doccia, interasse 100 mm, con kit composto da doccetta shut-off in abs cromato art. 332DPCR, flessibile conico in ottone cromato 120 cm e gancio cromato art. 332GA.

CLASS LINE

WINNER



**W 21**  
Miscelatore monocomando bidet senza scarico.



**W 10 SHW**  
Miscelatore monocomando lavabo con doccetta shut-off 332OW e scarico click-clack e troppo pieno.



**W 65 B**  
Miscelatore incasso per shut-off su piastra in ottone cromato, attacco conico da 1/2" e supporto shut-off.



**WC 31**  
Miscelatore monocomando esterno doccia, interasse 100 mm.

## VASCA



**W 02**  
Miscelatore vasca esterno con kit doccia con doccetta a 4 funzioni.



**W 03**  
Miscelatore monocomando per vasca, con deviatore integrato e kit doccia con doccetta a 4 funzioni.



**W 49**  
Miscelatore lavabo/vasca con canna fusa lunga, deviatore e kit doccia con doccetta a 4 funzioni, lunghezza canna 30 cm.



**W 05**  
Miscelatore vasca esterno senza kit doccia.



**W 04**  
Miscelatore monocomando per vasca, con deviatore integrato.



**W 46**  
Miscelatore lavabo/vasca con canna fusa lunga e deviatore senza kit doccia, lunghezza canna 30 cm.







**W 07**

Miscelatore monocomando bordo vasca con deviatore a leva integrato nella bocca minimale e doccetta estraibile in ABS cromato a 4 funzioni.



**W 07 UF**

Miscelatore monocomando bordo vasca con deviatore integrato nel miscelatore, bocca a cascata e doccetta estraibile in ABS cromato a 4 funzioni.

VANITY

INFINITY

DREAM

ATMOS

CLASS LINE

WINNER

## DOCCE



**W 38**

Miscelatore doccia esterno con kit doccia e doccetta a 4 funzioni.

**W 33**

Miscelatore doccia esterno senza kit doccia.



**W 39**

Miscelatore doccia esterno con kit doccia e doccetta a 4 funzioni.

**W 31**

Miscelatore doccia esterno senza kit doccia.



**315R 319M01**

Saliscendi cromato con asta tonda, con doccetta anticalcare ed idromassaggio con getti in silicone a 4 funzioni e flessibile in acciaio inox.

## COLONNE DOCCIA



**W 35**

Miscelatore doccia esterno con attacco superiore da 3/4".



**W 34**

Miscelatore vasca/doccia serie Winner con attacco superiore da 1/2" ed attacco inferiore da 1/2".



**W 34 34**

Miscelatore vasca/doccia serie Winner con attacco superiore da 3/4" ed attacco inferiore da 1/2".

## COLONNE DOCCIA

**W34 AEC20**

Miscelatore vasca/doccia con attacco superiore da 3/4" ed attacco inferiore da 1/2", colonna doccia telescopica, doccetta anticalcare a 4 funzioni, con flessibile 333 CNX 150 cm e soffione a pioggia in ABS cromato Ø 20 cm Art. 354EC20, con getti in silicone anticalcare.

**W37 AEC20**

Colonna doccia con miscelatore doccia e attacco superiore da 3/4", colonna doccia telescopica con deviatore, doccetta a 4 funzioni con getti anticalcare, con flessibile 333 CN 150 cm e soffione a pioggia in ABS cromato Ø 20 cm Art. 354EC20, con getti in silicone anticalcare.

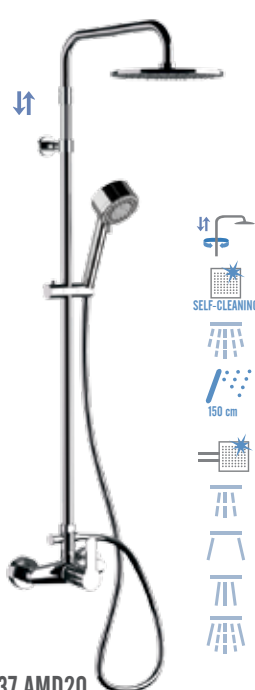
**W37 AMD20**

Colonna doccia con miscelatore doccia e attacco superiore da 3/4", colonna doccia telescopica con deviatore, doccetta a 4 funzioni con getti anticalcare, con flessibile 333 CN 150 cm e soffione a pioggia, in ABS cromato, Ø 20 cm Art. 356MD20, con getti in silicone anticalcare.

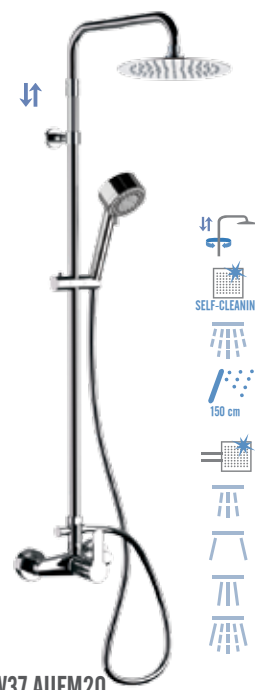
**W37 AUFM20**

Colonna doccia con miscelatore doccia e attacco superiore da 3/4", colonna doccia telescopica con deviatore, doccetta a 4 funzioni con getti anticalcare, con flessibile 333 CN 150 cm e soffione a pioggia, in acciaio INOX cromato, Ø 20 cm Art. 357UFM20, con getti in silicone anticalcare.

## INCASSI DOCCIA E BOCHE

**W 30**

Miscelatore monocomando da incasso per doccia.

**L 30 B**

Parte interna miscelatore monocomando incasso doccia.

**W 30 E**

Parte esterna miscelatore monocomando incasso doccia.

**W 09**

Miscelatore monocomando da incasso con deviatore per vasca/doccia.

**L 09 B**

Parte interna miscelatore monocomando incasso vasca/doccia con deviatore.

**W 09 E**

Parte esterna miscelatore monocomando incasso vasca/doccia con deviatore.

**91 L**

Bocca incasso cm 18.

**91 LD**

Bocca incasso con deviatore integrato, 18 cm.



**W 92**

Miscelatore monocomando per doccia, con deviatore a due posizioni (due uscite ed una entrata) su piastra unica.



**W 93**

Miscelatore monocomando per doccia con deviatore a tre vie (una entrata e tre uscite) su unica piastra.



**W 94**

Miscelatore monocomando per doccia, con deviatore a 4 posizioni (4 uscite ed 1 entrata) su piastra unica.

**W 93 7**

Miscelatore monocomando per doccia con deviatore a tre vie e sette posizioni (una entrata, tre uscite e sette posizioni con cui selezionare uscite singole o miscelate tra loro) su unica piastra.

**W 95**

Miscelatore monocomando per doccia, con deviatore a 5 posizioni (5 uscite ed una entrata) su piastra unica.

VANITY

INFINITY

DREAM

## BOX INCASSO

ATMOS

CLASS LINE

WINNER



**RR BOX**

Box da incasso per miscelatore doccia con deviatore.

**W 30 KB**

Set miscelatore doccia da abbinare al box incasso.



**RR BOX**

Box da incasso per miscelatore doccia con deviatore.

**W 09 KB**

Set miscelatore doccia con deviatore da abbinare al box incasso.



**RR BOX 93**

Box da incasso per miscelatore doccia tre vie.

**W 93 KB**

Set miscelatore doccia tre vie da abbinare al box incasso.



**RR BOX 92**

Box da incasso per miscelatore doccia due vie.

**W 92 KB**

Set miscelatore doccia due vie da abbinare al box incasso.



**RR BOX 93**

Box da incasso per miscelatore doccia tre vie.

**W 93 7 KB**

Set miscelatore doccia tre vie e sette posizioni da abbinare al box incasso.

## KIT WELLNESS



### W 09 S02 EC20

Set composto da: miscelatore monocomando da incasso con deviatore per vasca/doccia W09, presa acqua e supporto doccia in ottone cromato 337M con doccetta anticalcare ed idromassaggio con getti in silicone a 4 funzioni 319MO e flessibile 333CNX; braccio doccia in ottone cromato e rosetta cm 30 art. 343 e soffione a pioggia in ABS cromato Ø20 cm con getti anticalcare art. 354EC20.



### W 09 S01 EC20

Set composto da: miscelatore monocomando da incasso con deviatore per vasca/doccia W09, saliscendi cromato con asta tonda, con doccetta anticalcare ed idromassaggio con getti in silicone a 4 funzioni 315R 319MO, presa acqua 309L e flessibile in acciaio inox; braccio doccia in ottone cromato, rosetta cm 30 art. 343 e soffione a pioggia in ABS cromato Ø20 cm con getti anticalcare art. 354EC20.



### W 09 S01 UFM20

Set composto da: miscelatore monocomando da incasso con deviatore per vasca/doccia W09, saliscendi cromato con asta tonda, con doccetta anticalcare ed idromassaggio con getti in silicone a 4 funzioni 317M 319MO, presa acqua 309L e flessibile in acciaio inox; braccio doccia in ottone cromato e rosetta cm 30 art. 348N30 e soffione a pioggia in acciaio INOX, ultrapiatto, lucidato a specchio, Ø20 cm con getti anticalcare art. 357UFM20.

## COMPOSIZIONE DEL BOX:



# WINNER | SET

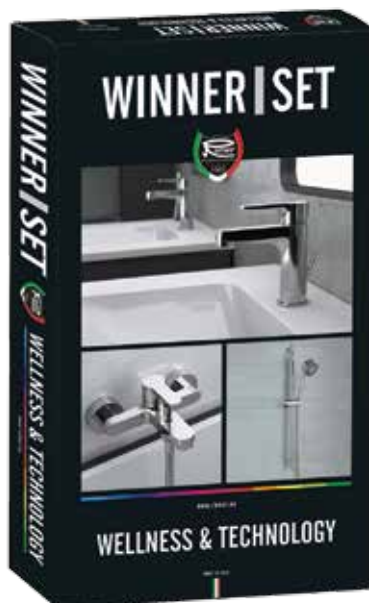

### W0510315RM01

Set composto da: miscelatore lavabo con scarico W10, miscelatore vasca W05 e saliscendi cromato con asta tonda, con doccetta anticalcare ed idromassaggio con getti in silicone a 4 funzioni 315R 319MO e flessibile in acciaio inox.



# WINNER | SET

COMPOSIZIONE DEL BOX:



**W0910315RM01**

Set composto da: miscelatore lavabo con scarico W10, miscelatore monocomando da incasso con deviatore per vasca/doccia W09, saliscendi cromato con asta tonda, con doccetta anticalcare ed idromassaggio con getti in silicone a 4 funzioni 315R 319MO, presa acqua 309L e flessibile in acciaio inox; braccio doccia in ottone cromato e rosetta cm 30 art. 343 e soffione a pioggia in ABS cromato Ø20 cm con getti anticalcare art. 354EC20.

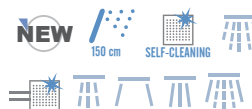

VANITY

INFINITY

DREAM

ATMOS

CLASS LINE

WINNER

COMPOSIZIONE DEL BOX:



**W051020315RM01**

Set composto da: miscelatore lavabo con scarico W10, bidet con scarico W20, miscelatore vasca W05 e saliscendi cromato con asta tonda, con doccetta anticalcare ed idromassaggio con getti in silicone a 4 funzioni 315R 319MO e flessibile in acciaio inox.





**CUCINA**



**W 72**  
Miscelatore monocomando monoforo 90°, con canna alta girevole a "U".



**W 72 C**  
Miscelatore monocomando per lavello, con canna corta girevole a "U", tipo lusso.

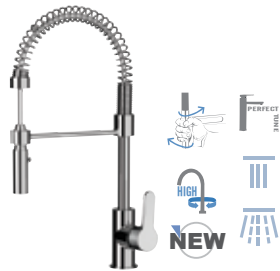

**W 533**  
Miscelatore lavello monocomando con flessibile nero rivestito con molla "fine design" girevole 360°, con doccetta estraibile di supporto ed orientabile a due funzioni e cartuccia Ø 35.



**W 77 E**  
Miscelatore monocomando lavello a molla con doccetta estraibile dal supporto ed orientabile a due funzioni e cartuccia Ø 35.



**W 42 B**  
Miscelatore monocomando per lavello, con bocca alta girevole.



**W 42 BC**  
Miscelatore monocomando per lavello, con bocca corta girevole.



**W 42 U**  
Miscelatore monocomando per lavello, con bocca alta quadrata a "U" girevole.



**W 42**  
Miscelatore monocomando per lavello, con bocca alta girevole.



**W 42 C**  
Miscelatore monocomando per lavello, con bocca corta girevole, tipo lusso.



**W 42 R**  
Miscelatore monocomando monoforo 90° per lavello, con bocca alta girevole ed orientabile, tipo lusso, modello sottofinestra.



**W 43**  
Miscelatore monocomando per lavello a muro, con leva frontale e bocca alta girevole.



**W 43 B**  
Miscelatore monocomando per lavello a muro, con leva frontale e bocca alta a "U" girevole.



**W 40**  
Miscelatore monocomando per lavello con canna girevole.



**W 41**  
Miscelatore monocomando per lavello a muro con canna lunghezza 20 cm.



**W 41 S**  
Miscelatore monocomando per lavello a muro con canna a "S" lunghezza 21 cm.



VANITY

INFINITY

DREAM

ATMOS

CLASS LINE

WINNER

## TOUCH-ME



### WT 72

Miscelatore monocomando lavello, monoforo 90° con canna alta ad "U" dotata di tecnologia Touch-Me con leva laterale e bocca girevole. Dotato di cartuccia Ø35.



### WT 72 C

Miscelatore monocomando lavello, monoforo 90° con canna corta ad "U" dotata di tecnologia Touch-Me con leva laterale e bocca girevole. Dotato di cartuccia Ø35.



### WT 72 U

Miscelatore monocomando lavello, monoforo 90° con canna alta quadra a "U" dotata di tecnologia Touch-Me con leva laterale e bocca girevole. Dotato di cartuccia Ø35.

## ACQUA PURIFICATA



### W 79 DW

Miscelatore lavello serie Winner a tre vie di ingresso con bocca girevole e due vie d'uscita completamente indipendenti, con selezione acqua potabile tramite la leva.





# X STYLE

## CARATTERISTICHE TECNICHE:

La serie è dotata di cartuccia a dischi ceramici, Ø 25 mm, prodotta da S.T.S.R. – Studio Tecnico Sviluppo e Ricerche - [www.stsr.it](http://www.stsr.it)

DESIGN MINIMALE

X STYLE

MINIMAL

JAZZ

Q DESIGN

QUBIKA

SO3







**SIMBOLOGIE:**

-   
 Con scarico con troppo pieno
-   
 Senza scarico
-   
 Con Click-Clack con Troppo Pieno
-   
 Proporzione perfetta.
-   
 Prodotto novità
-   
 Con Kit Doccia e flessibile lungo: 120, 150 o 200 cm
-   
 Doccetta Anticalcare
-   
 Soffione Anticalcare ed Autopulente
-   
 Ampio getto pioggia a risparmio idrico
-   
 Getto ad ampia copertura effetto pioggia

**LAVABI E BIDET**



**X 10**  
 Miscelatore monocomando lavabo senza scarico.  
 Altezza 179 mm, interasse 110 mm.



**X 10L XL**  
 Miscelatore monocomando lavabo con scarico click-clack.  
 Altezza 314 mm, interasse 165 mm.



**X 11**  
 Miscelatore monocomando lavabo senza scarico.  
 Altezza 179 mm, interasse 110 mm.



**X 11L XL**  
 Miscelatore monocomando lavabo senza scarico.  
 Altezza 314 mm, interasse 165 mm.

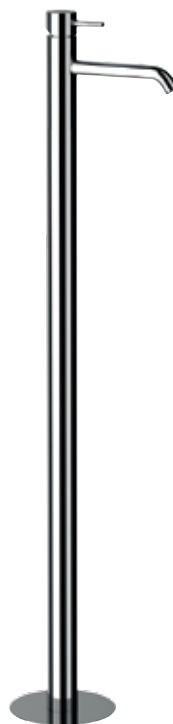

**X 18**  
 Miscelatore monocomando lavabo da pavimento con scarico click-clack.  
 Altezza 1036 mm, interasse 180 mm.



**X 15**  
 Miscelatore monocomando a incasso per lavabo, con piastra rettangolare in ottone cromato.



**X 15 P**  
 Miscelatore monocomando a incasso per lavabo, in ottone cromato.





LAVABO BOX INCASSO



**X 15 KB**

Miscelatore monocomando a incasso per lavabo, con piastra in ottone cromato da abbinare al box incasso.

NEW

+

**RR BOX 15**

Box da incasso per miscelatore monocomando a incasso per lavabo.

X STYLE

MINIMAL

BIDET



**X 20**

Miscelatore monocomando bidet.



**X 21**

Miscelatore monocomando bidet senza scarico.



**X 65 W**

Miscelatore incasso per shut-off comprensivo di doccetta shut-off art. 332OW, supporto doccia-presa acqua, attacco conico da 1/2" e supporto shut-off, tutto in ottone cromato, flessibile doccia cm 120.



**X 65 B**

Miscelatore incasso per shut-off su piastra in ottone cromato, attacco conico da 1/2" e supporto shut-off.

JAZZ

Q DESIGN

MISCELATORI VASCA E DOCCIA



**X 31**

Monocomando doccia esterno senza kit doccia.



**X 39**

Monocomando doccia esterno con kit doccia, flessibile 150 cm e doccetta ad una funzione in ottone cromato.



**X 05**

Miscelatore vasca esterno senza kit doccia.



**X 02**

Miscelatore vasca esterno con kit doccia, flessibile 150 cm e doccetta ad una funzione in ottone cromato.



**X 08**

Miscelatore vasca da pavimento, con deviatore, flessibile 150 cm e doccetta ad una funzione in ottone cromato. Altezza 925 mm, interasse 180 mm.

QUBIKA

S03

## X STYLE

## X STYLE

*La serie X Style è la sintesi perfetta di un design che basa la sua natura sull'essenza della minimalismo.*

*L'utilizzo della cartuccia diam. 25 mm rende i corpi miscelatore estremamente eleganti e slanciati.*

*Le bocche di erogazione dalla morbida curvatura esaltano la linea accompagnando dolcemente l'acqua nel suo fluire.*

*X Style è un miscelatore di classe dal design intramontabile. Disponibile in una scelta di finiture.*

*Il design della serie è stato ideato dal designer Cristian Mapelli, parte del Dipartimento di Ricerca e Sviluppo del Gruppo Remer ed ingegnerizzata e prodotta nei nostri stabilimenti produttivi situati in provincia di Milano.*





X STYLE

MINIMAL

JAZZ

Q DESIGN

QUBIKA

S03

## BOCCHIE ED INCASSI DOCCIA



**91 X**  
Bocca incasso,  
lunghezza 16,5 cm.



**X 30 L**  
Miscelatore doccia incasso.



**X 09 L**  
Miscelatore doccia incasso con deviatore.

**N 30 B**  
Parte interna miscelatore monocomando incasso doccia.

**N 09 B**  
Parte interna miscelatore monocomando incasso vasca/doccia con deviatore.

**X 30 LE**  
Parte esterna miscelatore monocomando incasso doccia.

**X 09 LE**  
Parte esterna miscelatore monocomando incasso vasca/doccia con deviatore.



**X 92**  
Miscelatore monocomando per doccia con deviatore a 2 posizioni su piastra unica.



**X 93**  
Miscelatore monocomando per doccia con deviatore a 3 vie e 3 posizioni (una entrata e tre uscite) su unica piastra.



**X 93 7**  
Miscelatore monocomando per doccia con deviatore a tre vie e sette posizioni (una entrata, tre uscite e sette posizioni con cui selezionare uscite singole o miscelate tra loro) su unica piastra.

## BOX INCASSO



**RR BOX**  
Box da incasso per miscelatore doccia con deviatore.



**X 30 KB**  
Set miscelatore doccia da abbinare al box incasso.



**RR BOX**  
Box da incasso per miscelatore doccia con deviatore.



**X 09 KB**  
Set miscelatore doccia con deviatore da abbinare al box incasso.



**NEW**  
+



### RR BOX 93

Box da incasso per miscelatore doccia tre vie.

### X 93 KB

Set miscelatore doccia tre vie da abbinare al box incasso.



**NEW**  
+



### RR BOX 92

Box da incasso per miscelatore doccia due vie.

### X 92 KB

Set miscelatore doccia due vie da abbinare al box incasso.



**NEW**  
+



### RR BOX 93

Box da incasso per miscelatore doccia tre vie.

### X 937 KB

Set miscelatore doccia tre vie e sette posizioni da abbinare al box incasso.

## WELLNESS



**NEW**



### X 09 S01

Set doccia composto da:  
Art. 357UFM20 348N 30: Soffione doccia ultra piatto Ø20 in acciaio INOX lucidato a specchio con braccio in ottone cm 30.  
Art. 317M 317MM con 333CN150: Saliscendi minimale con doccetta Minimal completamente in ottone cromato e flessibile conico in ottone cromato.  
Art. 309 L: presa acqua tipo rotondo pesante.  
Art. X 09 L: Miscelatore incasso con deviatore e piastra lusso.



**NEW**



### X 09 S02

Set doccia composto da:  
Art. 357UFM20 348N 30: Soffione doccia ultra piatto Ø20 in acciaio INOX lucidato a specchio con braccio in ottone cm 30.  
Art. 337M 317MM con 333CN150: doccetta Minimal completamente in ottone cromato con supporto presa acqua e flessibile conico in ottone cromato cm 150.  
Art. X 09 L: Miscelatore incasso con deviatore e piastra lusso.



**NEW**



### X 96 S02

Set doccia composto da:  
Art. 357UFM20 348N30: Soffione doccia ultra piatto Ø 20 cm in acciaio INOX lucidato a specchio con braccio in ottone cm 30.  
Art. X 96: Miscelatore e deviatore su piastre separate.  
Art. 337X 317MM con 333CN150: doccetta Minimal completamente in ottone cromato con supporto presa acqua e flessibile conico in ottone cromato cm 150.



# MINIMAL

## CARATTERISTICHE TECNICHE:

La serie è dotata di cartuccia a dischi ceramici Ø 35 mm, prodotta da S.T.S.R. - Studio Tecnico Sviluppo e Ricerche - [www.stsr.it](http://www.stsr.it)  
cromo, bianco opaco, nero opaco.





X STYLE

MINIMAL

JAZZ

Q DESIGN

QUBIKA

SO3



**SIMBOLOGIE:**

- |                              |                |                     |                                  |                       |                      |                 |  |  |                      |   |  |  |  |
|------------------------------|----------------|---------------------|----------------------------------|-----------------------|----------------------|-----------------|--|--|----------------------|---|--|--|--|
|                              |                |                     |                                  |                       |                      |                 |  |  |                      |   |  |  |  |
| Con scarico con troppo pieno | Senza scarico  | Con Click-Clack     | Con Click-Clack con Troppo Pieno | Proporzione perfetta. | Con getto a cascata. | Con multigetto. | Con Kit Doccia e flessibile lungo: 120, 150 o 200 cm | Doccetta Anticalcare                           | Soffione Autopulente | Getti Anticalcare   | Colonna doccia girevole.                 | Colonna doccia girevole e telescopica. |  |
|                              |                |                     |                                  |                       |                      |                 |  |  |                      |   |  |  |  |
| Corpo girevole               | Canna girevole | Canna alta girevole | Doccetta estraibile              | Acqua Potabile        | Doccetta orientabile | Prodotto novità | Con Batterie Alcaline Include                        | Getto con massaggio intenso a risparmio idrico | Getto Esterno        | Getto spray delicato ad ampia copertura con getto vigoroso all'esterno a risparmio idrico | Massaggio con getto vigoroso concentrato | Getto aerato intenso                   | Getto ad ampia copertura effetto pioggia |

CR = cromato

BO = bianco opaco

NO = nero opaco

**MANIGLIE:**

N 10



N 10 2



N 10 3



**LAVABI**



**N 10**

Miscelatore monocomando lavabo. Altezza 175 mm, interasse 110 mm.



**N 11**

Miscelatore monocomando lavabo, senza scarico. Altezza 175 mm, interasse 110 mm.



**N 10 A**

Miscelatore monocomando lavabo, bocca lunga. Altezza 215 mm, interasse 140 mm.



**N 11 A**

Miscelatore monocomando lavabo, bocca lunga, senza scarico. Altezza 215 mm, interasse 140 mm.



**N 10 L**  
Miscelatore monocomando lavabo alto L, su colonna.  
Altezza 295 mm, interasse 110 mm.



**N 10 L B**  
Miscelatore monocomando lavabo alto L, su colonna  
con scarico click-clack.  
Altezza 295 mm, interasse 110 mm.



**N 11 L**  
Miscelatore monocomando lavabo alto L, su colonna,  
senza scarico.  
Altezza 295 mm, interasse 110 mm.



**N 10 LXL**  
Miscelatore monocomando lavabo alto LXL,  
su colonna.  
Altezza 340 mm, interasse 180 mm.



**N 10 LXL B**  
Miscelatore monocomando lavabo alto LXL, su  
colonna con scarico click-clack.  
Altezza 340 mm, interasse 180 mm.



**N 11 LXL**  
Miscelatore monocomando lavabo alto LXL, su  
colonna senza scarico.  
Altezza 340 mm, interasse 180 mm.



**N 18**  
Miscelatore monocomando lavabo da terra  
con scarico click-clack.  
Altezza 1080 mm, interasse 180 mm.



**N 17**  
Miscelatore da soffitto in ottone cromato lunghezza  
166 cm, con miscelazione e controllo flusso integrati  
nella bocca di erogazione.

**N 17 L**  
Miscelatore da soffitto in ottone cromato lunghezza  
181 cm, con miscelazione e controllo flusso integrati  
nella bocca di erogazione.

**N 17 LXL**  
Miscelatore da soffitto in ottone cromato lunghezza  
231 cm, con miscelazione e controllo flusso  
integrati nella bocca di erogazione.



X STYLE

MINIMAL

JAZZ

Q DESIGN

QUBIKA

S03



**N 57**  
Miscelatore monocomando lavabo due fori senza scarico.



**N 14**  
Miscelatore monocomando a incasso per lavabo con piastra verticale rettangolare in ottone cromato e bocca minimal 18 cm.



**N 15**  
Miscelatore monocomando a incasso con piastra rettangolare in ottone cromato e bocca minimal 18 cm.

## LAVABO BOX INCASSO

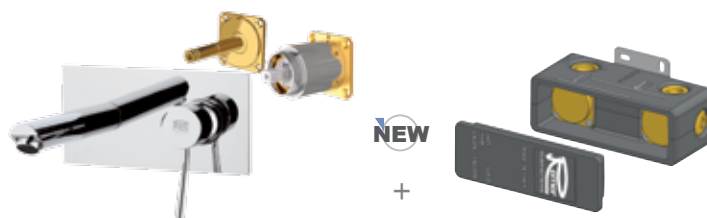

**N 15 KB**  
Miscelatore monocomando a incasso per lavabo, con piastra in ottone cromato da abbinare al box incasso.

**RR BOX15**  
Box da incasso per miscelatore monocomando a incasso per lavabo.

## BIDET



**N 20**  
Miscelatore monocomando per bidet, con aeratore direzionabile.



**N 21**  
Miscelatore monocomando per bidet, con aeratore direzionabile.



**N 10 SH**  
Miscelatore monocomando lavabo con doccetta shut-off 332OL e scarico click-clack e troppo pieno.



**N 64 W**  
Miscelatore shut-off con cartuccia progressiva, apertura su acqua fredda e passaggio ad acqua calda tramite rotazione di maniglia unica, comprensivo di doccetta shut-off art. 332OW e flessibile doccia cm 120.



**N 65**  
Miscelatore incasso per shut-off comprensivo di doccetta shut-off art. 332OL, supporto doccia-presa acqua, attacco conico da 1/2" e supporto shut-off, tutto in ottone cromato, flessibile doccia cm 120.



**N 65 B**  
Miscelatore incasso per shut-off su piastra in ottone cromato, attacco conico da 1/2" e supporto shut-off.





## N 60

Miscelatore incasso per shut-off comprensivo di: doccetta shut-off art 332 OL, supporto doccia-presa acqua su piastra in ottone cromato e flessibile doccia cm 120.



## N 23

Miscelatore monocomando per bidet, con doccetta.



## N 24

Miscelatore monocomando per bidet, con deviatore e doccetta.



## N 63

Miscelatore incasso per shut-off.

X STYLE

MINIMAL

JAZZ

## BOCCHIE



## 91 V N2

Bocca da soffitto in ottone cromato lunghezza 166 cm.



## 91 VL N2

Bocca da soffitto in ottone cromato lunghezza 181 cm.



## 91 M

Bocca incasso per miscelatore vasca/doccia, cm 18.



## 91 MD

Bocca incasso per miscelatore vasca/doccia, con deviatore integrato, cm 18.



## 91 N2

Bocca incasso per miscelatore vasca-doccia, cm 18.

Q DESIGN

QUBIKA

S03

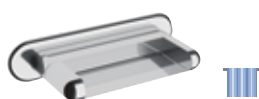

## 91 NC

Bocca incasso cascata con bordi arrotondati.



## 91 NCF

Bocca bordo vasca con effetto multigetto ed angoli arrotondati.



## 359 NC

Soffione doccia con getto a cascata bordi arrotondati.

**VASCA**

**N 02**

Miscelatore monocomando per vasca, esterno, con doccia duplex.

**N 05**

Miscelatore monocomando per vasca, esterno, senza doccia.

**N 04**

Miscelatore monocomando a incasso per vasca, su piastra rettangolare, con bocca lunga cm 18, deviatore e kit doccia integrato.

**N 03**

Miscelatore monocomando lavabo/vasca, con deviatore integrato e kit doccia.

**N 27**

Miscelatore bordo vasca con deviatore integrato nel miscelatore e doccetta estraibile minimale.

**N 07**

Miscelatore monocomando bordo vasca con deviatore a leva integrato nella bocca minimale e doccetta estraibile.

**N 06**

Miscelatore monocomando bordo vasca con deviatore, bocca con effetto multigetto e doccetta estraibile in ABS a 4 funzioni.

**N 06 317 MM**

Miscelatore monocomando bordo vasca con deviatore, bocca con effetto multigetto e doccetta estraibile in ottone cromato.

**N 08**

Miscelatore vasca da pavimento con deviatore e kit doccia, senza scarico. Altezza 920 mm, interasse 195 mm.

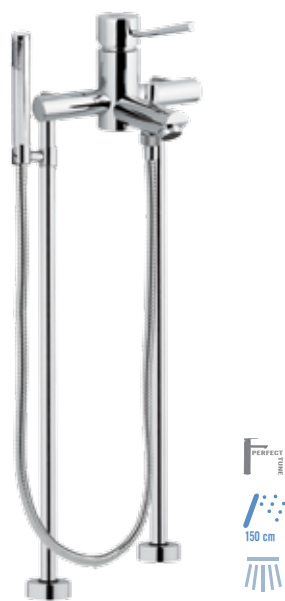
**N 02 XL**

Gruppo vasca esterno su colonne da pavimento Minimal, con doccia.

**88 N 02**

Coppia colonne vasca in ottone cromato, serie Minimal, con supporto doccia, 3/4M x 3/4M.

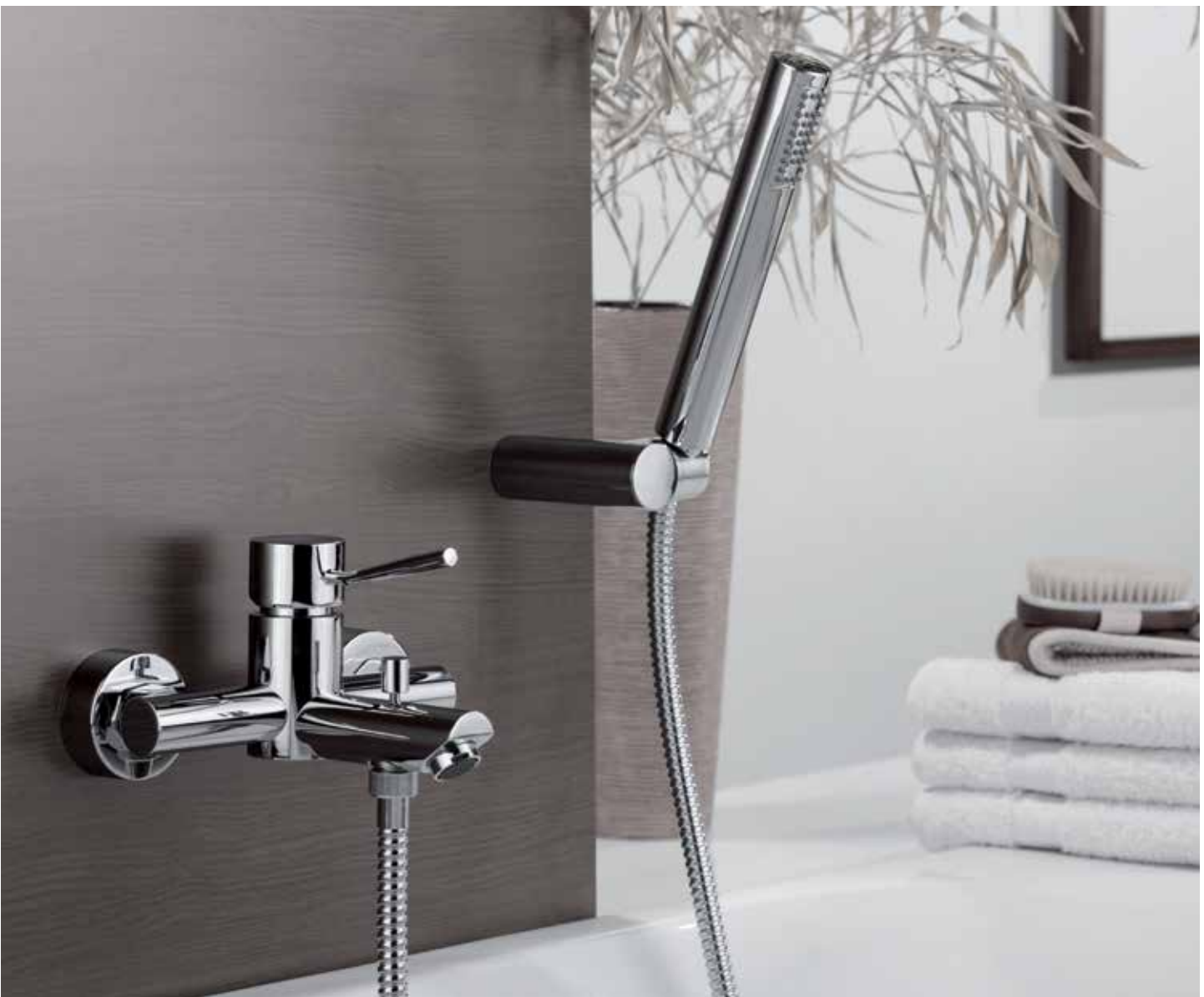

X STYLE

MINIMAL

JAZZ

Q DESIGN

QUBIKA

S03

DOCCE



**317M 317DM**  
Saliscendi minimale con doccetta anti-calcare.



150 cm



**N 31**  
Miscelatore monocomando esterno per doccia.



**N 39**  
Miscelatore monocomando esterno per doccia, con doccia duplex.



150 cm



**N 35**  
Gruppo doccia a muro, con deviatore integrato ed attacco superiore per colonna da 3/4.



**N 35 R**  
Gruppo doccia a muro minimale, con attacco superiore per colonna da 3/4.

## INCASSI



### N 09

Miscelatore monocomando incasso con deviatore per vasca/doccia.

### N 09 B

Parte interna miscelatore monocomando incasso vasca/doccia con deviatore.

### N 09 E

Parte esterna miscelatore monocomando incasso vasca/doccia con deviatore.



### N 30

Miscelatore monocomando incasso per doccia.

### N 30 B

Parte interna miscelatore monocomando incasso doccia.

### N 30 E

Parte esterna miscelatore monocomando incasso doccia.



### N 09 L

Miscelatore monocomando incasso con deviatore per vasca/doccia, con piastra lusso.

### N 09 B

Parte interna miscelatore monocomando incasso vasca/doccia con deviatore.

### N 09 LE

Parte esterna miscelatore monocomando incasso vasca/doccia con deviatore, con piastra lusso.



### N 30 L

Miscelatore monocomando incasso per doccia, con piastra lusso.

### N 30 B

Parte interna miscelatore monocomando incasso doccia.

### N 30 LE

Parte esterna miscelatore monocomando incasso doccia, con piastra lusso.



### N 92

Miscelatore monocomando a incasso per doccia, con deviatore a due posizioni (due uscite ed una entrata) su piastra unica.



### N 93

Miscelatore monocomando per doccia con deviatore a tre vie (una entrata e tre uscite) su unica piastra.

### N 93 7

Miscelatore monocomando per doccia con deviatore a tre vie e sette posizioni (una entrata, tre uscite e sette posizioni con cui selezionare uscite singole o miscelate tra loro) su unica piastra.



### N 94

Miscelatore monocomando per doccia, con deviatore a 4 posizioni (4 uscite ed 1 entrata) su piastra unica.

### N 95

Miscelatore monocomando per doccia, con deviatore a 5 posizioni (5 uscite ed una entrata) su piastra unica.



### N 94 C

Miscelatore monocomando per doccia, con deviatore a 4 posizioni (4 uscite ed una entrata) su doppia piastra, con possibilità di chiusura del flusso dal deviatore durante il cambio di posizione.

### N 95 C

Miscelatore monocomando per doccia, con deviatore a 5 posizioni (5 uscite ed una entrata) su doppia piastra, con possibilità di chiusura del flusso dal deviatore durante il cambio di posizione.

BOX INCASSO



**RR BOX**  
Box da incasso per miscelatore doccia con deviatore.

**N 30 KB**  
Set miscelatore doccia da abbinare al box incasso.



**RR BOX**  
Box da incasso per miscelatore doccia con deviatore.

**N 09 KB**  
Set miscelatore doccia con deviatore da abbinare al box incasso.



**RR BOX93**  
Box da incasso per miscelatore doccia tre vie.

**N 93 KB**  
Set miscelatore doccia tre vie da abbinare al box incasso.



**RR BOX92**  
Box da incasso per miscelatore doccia due vie.

**N 92 KB**  
Set miscelatore doccia due vie da abbinare al box incasso.



**RR BOX93**  
Box da incasso per miscelatore doccia tre vie.

**N 93 7 KB**  
Set miscelatore doccia tre vie e 7 posizioni da abbinare al box incasso.

X STYLE

MINIMAL

JAZZ

Q DESIGN

QUBIKA

S03





**COLONNE DOCCIA FREESTANDING - COLONNE DOCCIA PER PISCINA**
**MONOACQUA**

**331 N2**

Colonna con miscelatore acqua calda-fredda saliscendi free-standing con attacco da pavimento, tutta in ottone cromato per doccia, spa, piscina etc, forma minimale rotonda, con deviatore, doccetta in ottone cromato e flessibile doccia cm 200, soffione anti-calcare in ottone cromato Ø cm 30.

**331 N52**

Colonna free-standing con miscelatore acqua calda-fredda, con attacco da pavimento tutta in ottone cromato per doccia, spa, piscina etc, forma minimale rotonda con soffione anti-calcare in ottone cromato Ø cm 30.

**331 N1**

Colonna saliscendi free-standing in ottone cromato con attacco da pavimento per doccia, spa, piscina etc, forma minimale rotonda, con comando monoacqua, deviatore, doccetta in ottone cromato e flessibile doccia cm 200, soffione anti-calcare in ottone cromato Ø cm 30.

**331 N51**

Colonna free-standing in ottone cromato con attacco da pavimento per doccia, spa, piscina etc, forma minimale rotonda, con comando monoacqua e soffione anti-calcare in ottone cromato Ø cm 30.

**COLONNE DOCCIA**

**N 37**

Miscelatore esterno doccia con deviatore integrato e colonna deluxe saliscendi girevole, completa di soffione anti-calcare in ABS cromo-satinato Art. 356LUX Ø 24 cm, doccetta in abs cromato e flessibile in ottone.

**N 37 XL**

Miscelatore esterno doccia con deviatore integrato e colonna deluxe saliscendi girevole, completa di soffione XL in ottone cromato anti-calcare Art. 358MMXL Ø 35 cm, doccetta in abs cromato e flessibile in ottone.

**N 37 R**

Miscelatore esterno doccia, colonna deluxe con deviatore e saliscendi, completa di soffione anti-calcare in ottone cromato Art. 359MM20 Ø 20 cm, doccetta in Abs cromato e flessibile in ottone.



**N 37 B**

Miscelatore esterno doccia N35 con colonna doccia minimale con saliscendi e deviatore, doccetta anti-calcare in abs cromato 317DM e soffione in abs cromato ed anti-calcare 356MD20 Ø 20 cm. Flessibile in ottone cromato incluso.



**N 37 B XL**

Miscelatore esterno doccia N35 con colonna doccia minimale con saliscendi e deviatore, doccetta anti-calcare in abs cromato 317DM e soffione in abs cromato ed anti-calcare 356MD25 Ø 25 cm.



**N 37 RB**

Miscelatore esterno doccia N35R, colonna Minimal con deviatore e saliscendi girevole, completa di soffione anti-calcare in Abs cromato 356MD20 Ø 20 cm e doccetta anti-calcare in Abs cromato Art. 317DM e flessibile in ottone.



**N37 RA MD20**

Colonna doccia serie Minimal con miscelatore doccia attacco superiore da 3/4", colonna doccia telescopica con deviatore, doccetta anti-calcare ad 1 funzione, con flessibile 333 CN 150 cm e soffione a pioggia, in ABS cromato Art. 356MD20 Ø 20 cm, con getti in silicone anti-calcare.

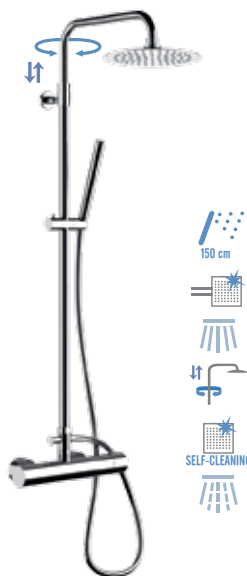

**N37 RA7MM UFM20**

Colonna doccia serie Minimal con miscelatore doccia e attacco superiore da 3/4", colonna doccia telescopica con deviatore, doccetta ad 1 funzione, con flessibile 333 CN 150 cm e soffione a pioggia, in acciaio INOX Art. 357UFM20 Ø 20 cm, con getti in silicone anti-calcare.

X STYLE

MINIMAL

JAZZ

Q DESIGN

QUBIKA

S03

## WELLNESS



Set doccia composto da:  
 Art. 357UFM 348N: Soffione doccia ultra piatto in acciaio INOX lucidato a specchio con braccio in ottone cromato.  
 Art. 317M 317MM con 333CN150: Saliscendi minimale con doccetta Minimal completamente in ottone cromato e flessibile conico in ottone cromato.  
 Art. 309 L: presa acqua tipo rotondo pesante.  
 Art. N 09 L: Miscelatore incasso con deviatore e piastra lusso.



ARTICOLO	DESCRIZIONE
<b>N 09 S01 UFM20</b>	Con 357UFM20: Soffione doccia ultra piatto Ø20 cm, con braccio 30 cm.
<b>N 09 S01 UFM25</b>	Con 357UFM25: Soffione doccia ultra piatto Ø25 cm, con braccio 30 cm.
<b>N 09 S01 UFM30</b>	Con 357UFM30: Soffione doccia ultra piatto Ø30 cm, con braccio 30 cm.
<b>N 09 S01 UFM40</b>	Con 357UFM40: Soffione doccia ultra piatto Ø40 cm, con braccio 40 cm.



Set doccia composto da:  
 Art. 357UFM 348N: Soffione doccia ultra piatto in acciaio INOX lucidato a specchio con braccio in ottone cromato.  
 Art. 317M 317MM con 333CN150: Saliscendi minimale con doccetta Minimal completamente in ottone cromato e flessibile conico in ottone cromato.  
 Art. 309 L: presa acqua tipo rotondo pesante.  
 Art. N 93 7: miscelatore monocomando per doccia con deviatore a tre vie e sette posizioni su unica piastra.  
 Art. N 34 JET: 6 getti minimali anti-calcare in ottone cromato.



ARTICOLO	DESCRIZIONE
<b>N 93 7 S02 UFM20</b>	Con 357UFM20: Soffione doccia ultra piatto Ø20 cm, con braccio 30 cm.
<b>N 93 7 S02 UFM25</b>	Con 357UFM25: Soffione doccia ultra piatto Ø25 cm, con braccio 30 cm.
<b>N 93 7 S02 UFM30</b>	Con 357UFM30: Soffione doccia ultra piatto Ø30 cm, con braccio 30 cm.
<b>N 93 7 S02 UFM40</b>	Con 357UFM40: Soffione doccia ultra piatto Ø40 cm, con braccio 40 cm.



Set doccia composto da:  
 Art. 357UFM 348N: Soffione doccia ultra piatto in acciaio INOX lucidato a specchio con braccio in ottone cromato.  
 Art. 337M 317MM con 333CN150: Doccia duplex Minimal completamente in ottone cromato con supporto presa acqua e flessibile conico in ottone cromato cm 150.  
 Art. N 09 L: Miscelatore incasso con deviatore e piastra lusso.



ARTICOLO	DESCRIZIONE
<b>N 09 S02 UFM20</b>	Con 357UFM20: Soffione doccia ultra piatto Ø20 cm, con braccio 30 cm.
<b>N 09 S02 UFM25</b>	Con 357UFM25: Soffione doccia ultra piatto Ø25 cm, con braccio 30 cm.
<b>N 09 S02 UFM30</b>	Con 357UFM30: Soffione doccia ultra piatto Ø30 cm, con braccio 30 cm.
<b>N 09 S02 UFM40</b>	Con 357UFM40: Soffione doccia ultra piatto Ø40 cm, con braccio 40 cm.



Set doccia composto da:  
 Art. 357UFM 348N: Soffione doccia ultra piatto in acciaio INOX lucidato a specchio con braccio in ottone cromato.  
 Art. 337M 317MM con 333CN150: Doccia duplex Minimal completamente in ottone cromato con supporto presa acqua e flessibile conico in ottone cromato cm 150.  
 Art. N 93 7: miscelatore monocomando per doccia con deviatore a tre vie e sette posizioni su unica piastra.  
 Art. N 34 JET: 6 getti minimali anti-calcare in ottone cromato.



ARTICOLO	DESCRIZIONE
<b>N 93 7 S01 UFM20</b>	Con 357UFM20: Soffione doccia ultra piatto Ø20 cm, con braccio 30 cm.
<b>N 93 7 S01 UFM25</b>	Con 357UFM25: Soffione doccia ultra piatto Ø25 cm, con braccio 30 cm.
<b>N 93 7 S01 UFM30</b>	Con 357UFM30: Soffione doccia ultra piatto Ø30 cm, con braccio 30 cm.
<b>N 93 7 S01 UFM40</b>	Con 357UFM40: Soffione doccia ultra piatto Ø40 cm, con braccio 40 cm.

## DESIGN MINIMALE



### N 94 S01 UFMCA

Set doccia composto da:

Art. 350UFMCA: Soffione doccia ultrapiatto 50x25 cm, a parete in acciaio INOX lucidato a specchio, 2 getti, normale o cascata.

Art. 317M 317MM con 333CN150: Saliscendi minimale con doccetta Minimal completamente in ottone cromato e flessibile conico in ottone cromato.

Art. 309 L: presa acqua tipo rotondo pesante.

Art. N 94: miscelatore monocomando per doccia con deviatore a 4 posizioni su piastra unica.

Art. N 34 JET: 6 getti minimali anti-calcare in ottone cromato.



X STYLE

MINIMAL

JAZZ

Q DESIGN

QUBIKA

S03



### N 93 7 S01 UFM

Set doccia composto da:

Art. 350UFM: Soffione doccia ultrapiatto 50x25 cm, a parete in acciaio INOX lucidato a specchio, getto a pioggia.

Art. 317M 317MM con 333CN150: Saliscendi minimale con doccetta Minimal completamente in ottone cromato e flessibile conico in ottone cromato.

Art. 309 L: presa acqua tipo rotondo pesante.

Art. N 937: miscelatore monocomando per doccia con deviatore a 3 vie e 7 posizioni su piastra unica.

Art. N 34 JET: 6 getti minimali anti-calcare in ottone cromato.





### N 93 7 S01 UFMCA

Set doccia composto da:

Art. 350UFMCA: Soffione doccia ultrapiatto 50x25 cm, a parete in acciaio INOX lucidato a specchio, 2 getti, normale o cascata.

Art. 317M 317MM con 333CN150: Saliscendi minimale con doccetta Minimal completamente in ottone cromato e flessibile conico in ottone cromato.

Art. 309 L: presa acqua tipo rotondo pesante.

Art. N 93 7: miscelatore monocomando per doccia con deviatore a tre vie e sette posizioni su unica piastra.



### N 09 S01 UFM

Set doccia composto da:

Art. 350UFM: Soffione doccia ultrapiatto 50x25 cm, a parete in acciaio INOX lucidato a specchio, getto a pioggia.

Art. 317M 317MM con 333CN150: Saliscendi minimale con doccetta Minimal completamente in ottone cromato e flessibile conico in ottone cromato.

Art. 309 L: presa acqua tipo rotondo pesante.

Art. N 09 L: Miscelatore incasso con deviatore e piastra lusso.



### N 94 S02 UFMCA

Set doccia composto da:

Art. 350UFMCA: Soffione doccia ultrapiatto 50x25 cm, a parete in acciaio INOX lucidato a specchio, 2 getti, normale o cascata.

Art. 337M 317MM con 333CN150: Doccia duplex Minimal completamente in ottone cromato con supporto presa acqua e flessibile conico in ottone cromato cm 150.

Art. N 94: miscelatore monocomando per doccia con deviatore a 4 posizioni su piastra unica.

Art. N 34 JET: 6 getti minimali anti-calcare in ottone cromato.



### N 93 7 S02 UFM

Set doccia composto da:

Art. 350UFM: Soffione doccia ultrapiatto 50x25 cm, a parete in acciaio INOX lucidato a specchio, getto a pioggia.

Art. 337M 317MM con 333CN150: Doccia duplex Minimal completamente in ottone cromato con supporto presa acqua e flessibile conico in ottone cromato cm 150.

Art. N 93 7: miscelatore monocomando per doccia con deviatore a tre vie e sette posizioni su unica piastra.

Art. N 34 JET: 6 getti minimali anti-calcare in ottone cromato.



### N 93 7 S02 UFMCA

Set doccia composto da:

Art. 350UFMCA: Soffione doccia ultrapiatto 50x25 cm, a parete in acciaio INOX lucidato a specchio, 2 getti, normale o cascata.

Art. 337M 317MM con 333CN150: Doccia duplex Minimal completamente in ottone cromato con supporto presa acqua e flessibile conico in ottone cromato cm 150.

Art. N 93 7: miscelatore monocomando per doccia con deviatore a tre vie e sette posizioni su unica piastra.



### N 09 S02 UFM

Set doccia composto da:

Art. 350UFM: Soffione doccia ultrapiatto 50x25 cm, a parete in acciaio INOX lucidato a specchio, getto a pioggia.

Art. 337M 317MM con 333CN150: Doccia duplex Minimal completamente in ottone cromato con supporto presa acqua e flessibile conico in ottone cromato cm 150.

Art. N 09 L: Miscelatore incasso con deviatore e piastra lusso.







## N 09 S01

Set doccia composto da:  
 Art. 356LU 348N 30: Soffione minimale anti-calcare con braccio in ottone cm 30.  
 Art. 317M 317DM con 333CN 150: Saliscendi minimale con doccetta anti-calcare e flessibile conico in ottone cromato.  
 Art. 309 L: presa acqua tipo rotondo pesante.  
 Art. N 09 L: Miscelatore incasso con deviatore e piastra lusso.



## N 93 7 S02

Set doccia composto da:  
 Art. 359MM30 348N 30: soffione minimale anti-calcare in ottone Ø 30, con braccio in ottone cm 30.  
 Art. 317G 321HG con 333CN 150: Saliscendi in ottone cromato e doccetta minimale a 3 funzioni con getti in silicone e flessibile conico in ottone cromato cm 150.  
 Art. 309 L: presa acqua tipo rotondo pesante.  
 Art. N 34 JET: 6 getti minimali anti-calcare in ottone cromato.  
 Art. N 93 7: miscelatore monocomando per doccia con deviatore a tre vie e sette posizioni su unica piastra.



X STYLE

MINIMAL

JAZZ

Q DESIGN

QUBIKA

S03



## N 09 S03

Set doccia composto da:  
 Art. 356LU 348N 30: Soffione minimale anti-calcare con braccio in ottone cm 30.  
 Art. 339N 317DM con 333CN 150: Doccia duplex minimale anti-calcare con supporto duplex e flessibile conico in ottone cromato cm 150.  
 Art. 91 MD: Bocca incasso Minimal con deviatore integrato.  
 Art. N 09 L: Miscelatore incasso con deviatore e piastra lusso



## N 93 7 S01

Set doccia composto da:  
 Art. 359MM30 348N 30: soffione minimale anti-calcare in ottone Ø 30, con braccio in ottone cm 30.  
 Art. 337M 321HG con 333CN 150: Doccetta a 3 funzioni, con getti in silicone, supporto doccia duplex in ottone cromato con presa acqua e flessibile conico in ottone cromato cm 150.  
 Art. N34JET: 6 getti minimali anti-calcare in ottone cromato.  
 Art. N 93 7: miscelatore monocomando per doccia con deviatore a tre vie e sette posizioni su unica piastra.



## N 09 S11

Set doccia composto da:  
 Art. 330U 356LU 317DM 330RA con 333CN 150: Colonna doccia deluxe girevole con deviatore e saliscendi, completa di soffione doccia cromato anti-calcare, doccetta minimale, flessibile doccia e supporto presa acqua per colonna.  
 Art. N 09 L: Miscelatore monocomando incasso con deviatore e piastra lusso.  
 Art. 91M: Bocca incasso Minimale.



## N 09 S02

Set doccia composto da:  
 Art. 356LU 348N 30: Soffione minimale anti-calcare con braccio in ottone cm 30.  
 Art. 337M 317DM con 333CN 150: Doccia duplex minimale anti-calcare con supporto presa acqua e flessibile conico in ottone cromato cm 150.  
 Art. N 09 L: Miscelatore incasso con deviatore e piastra lusso.





## CUCINA



**N 40**

Miscelatore monocomando per lavello, con bocca girevole, altezza bocca mm 160.



**N 40 L**

Miscelatore monocomando per lavello, con bocca girevole, altezza bocca mm 280.



**N 41**

Miscelatore monocomando per lavello a muro, con bocca girevole lunghezza 20 cm.



**NK2 72**

Miscelatore monocomando lavello, con bocca girevole e corpo tondo.



**NEW**



**N 77 E**

Miscelatore monocomando lavello a molla con doccetta estraibile ed orientabile a due funzioni e cartuccia Ø 35.



**N 47**

Miscelatore monocomando per lavello, con bocca estraibile e girevole.



X STYLE

MINIMAL

JAZZ

Q DESIGN

QUBIKA

S03



**N 48 319 MO**

Miscelatore monocomando bordo lavello con deviatore a leva integrato nella bocca minimale e doccetta cromata minimale estraibile a 4 funzioni con getti in silicone, idromassaggio ed anti-calcare.



**N 48 332 EU**

Miscelatore monocomando bordo lavello con deviatore a leva integrato nella bocca minimale e doccetta estraibile a pulsante minimale in ABS, cromata con impugnatura liscia 1/2".

**CUCINA ACQUA POTABILE**



**N 40 DW**

Miscelatore lavello Minimale a tre vie di ingresso con bocca girevole, con selezione acqua potabile tramite la leva, con due vie d'uscita completamente indipendenti.



**N 792 DW**

Miscelatore lavello serie Minimal a tre vie di ingresso con bocca girevole e due vie d'uscita completamente indipendenti, con selezione acqua potabile tramite la leva.



**TTEN 40 DW**

Miscelatore lavello Minimale a tre vie di ingresso con bocca girevole, con selezione acqua potabile tramite pulsante ad azionamento piezoelettrico alimentato a batteria, con due vie d'uscita completamente indipendenti.

# JAZZ

## CARATTERISTICHE TECNICHE:

La serie è dotata di cartuccia a dischi ceramici joystick Ø 29 mm, prodotta da S.T.S.R. - Studio Tecnico Sviluppo e Ricerche - [www.stsr.it](http://www.stsr.it)  
cromo, bianco opaco, nero opaco.

X STYLE

MINIMAL

JAZZ

Q DESIGN

QUBIKA

SC3





JAZZ

**SIMBOLOGIE:**

-  Con scarico con troppo pieno
-  Senza scarico
-  Con Click-Clack
-  Con Click-Clack con Troppo Pieno
-  Proporzione perfetta.
-  Con Kit Doccia e flessibile lungo: 120, 150 o 200 cm
-  Doccetta Anti-calcare
-  Soffione Autopulente
-  Getti Anti-calcare
-  Colonna doccia girevole.
-  Doccetta estraibile
-  Corpo girevole
-  Canna girevole
-  Canna alta girevole
-  Con getto a cascata.
-  Con multigetto.
-  Getto con massaggio intenso a risparmio idrico
-  Massaggio con getto vigoroso concentrato
-  Getto Esterno
-  Ampio getto pioggia a risparmio idrico
-  Getto spray delicato ad ampia copertura con getto vigoroso all'esterno a risparmio idrico
-  Getto ad ampia copertura effetto pioggia
-  Getto aerato intenso

CR = cromato

BO = bianco opaco

NO = nero opaco

**LAVABI**



**J 10**  
Miscelatore monocomando lavabo.  
Altezza 215 mm, interasse 110 mm.



**J 11**  
Miscelatore monocomando lavabo senza scarico.  
Altezza 215 mm, interasse 110 mm.



**J 15**  
Miscelatore monocomando a incasso per lavabo serie Jazz, con piastra rettangolare in ottone cromato e bocca minimal lunghezza 18 cm.



**J 10 L**  
Miscelatore monocomando lavabo alto L, su colonna.  
Altezza 335 mm, interasse 110 mm.



**J 10 L B**  
Miscelatore monocomando lavabo alto L, su colonna con scarico click-clack.  
Altezza 335 mm, interasse 110 mm.



**J 11 L**  
Miscelatore monocomando lavabo alto L, su colonna, senza scarico.  
Altezza 335 mm, interasse 110 mm.



**J 10 LXL**  
Miscelatore monocomando lavabo alto LXL, su colonna.  
Altezza 390 mm, interasse 165 mm.



**J 10 LXL B**  
Miscelatore monocomando lavabo alto LXL, su colonna, con scarico click-clack.  
Altezza 390 mm, interasse 165 mm.



**J 11 LXL**  
Miscelatore monocomando lavabo alto LXL, su colonna, senza scarico.  
Altezza 390 mm, interasse 165 mm.





X STYLE

MINIMAL

JAZZ



Q DESIGN

QUBIKA

S03

## LAVABO BOX INCASSO



NEW

+

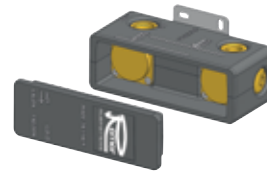

### J 15 KB

Miscelatore monocomando a incasso per lavabo, con piastra in ottone cromato da abbinare al box incasso.

### RR BOX 15

Box da incasso per miscelatore monocomando a incasso per lavabo.

## BIDET



### J 20

Miscelatore monocomando per bidet, con aeratore direzionabile.



### J 21

Miscelatore monocomando per bidet, con aeratore direzionabile, senza scarico.



### J 23

Miscelatore monocomando per bidet con doccetta.

## VASCA



### J 02

Miscelatore monocomando per vasca, esterno, con doccia duplex.



### J 05

Miscelatore monocomando per vasca, esterno, senza doccia.



### J 07

Miscelatore monocomando bordo vasca con deviatore a leva integrato nella bocca minimale e doccetta estraibile minimale in ottone cromato.



### J 06

Miscelatore monocomando bordo vasca con deviatore, bocca con effetto multigetto e doccetta estraibile in ottone cromato.

INCASSI



**J 09**  
Miscelatore monocomando da incasso con deviatore per vasca/doccia.



**J 09 L**  
Miscelatore monocomando da incasso con deviatore per vasca/doccia, con piastra lusso.



**J 30**  
Miscelatore monocomando da incasso per doccia.



**J 30 L**  
Miscelatore monocomando da incasso per doccia, con piastra lusso.

**N 09 B**  
Parte interna miscelatore monocomando incasso vasca/doccia con deviatore.

**N 09 LB**  
Parte interna miscelatore monocomando incasso vasca/doccia con deviatore.

**N 30 B**  
Parte interna miscelatore monocomando incasso doccia.

**N 30 LB**  
Parte interna miscelatore monocomando incasso doccia.

**J 09 E**  
Parte esterna miscelatore monocomando incasso vasca/doccia con deviatore.

**J 09 L E**  
Parte esterna miscelatore monocomando incasso vasca/doccia con deviatore, con piastra lusso.

**J 30 E**  
Parte esterna miscelatore monocomando incasso doccia.

**J 30 L E**  
Parte esterna miscelatore monocomando incasso doccia, con piastra lusso.

X STYLE

MINIMAL

JAZZ

BOX INCASSO



**RR BOX**  
Box da incasso per miscelatore doccia con deviatore.

**J 30 KB**  
Set miscelatore doccia da abbinare al box incasso.



**RR BOX**  
Box da incasso per miscelatore doccia con deviatore.

**J 09 KB**  
Set miscelatore doccia con deviatore da abbinare al box incasso.



**RR BOX 93**  
Box da incasso per miscelatore doccia tre vie.

**J 93 KB**  
Set miscelatore doccia tre vie da abbinare al box incasso.



**RR BOX 92**  
Box da incasso per miscelatore doccia due vie.

**J 92 KB**  
Set miscelatore doccia due vie da abbinare al box incasso.



**RR BOX 93**  
Box da incasso per miscelatore doccia tre vie.

**J 93 7 KB**  
Set miscelatore doccia tre vie e 7 posizioni da abbinare al box incasso.

Q DESIGN

QUBIKA

S03

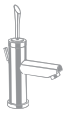

JAZZ

## BOCCHHE



**91 M**

Bocca incasso per miscelatore vasca-doccia, cm 18.



**91 MD**

Bocca incasso per miscelatore vasca-doccia, con deviatore integrato, cm 18.



**359 NC**

Soffione doccia con bordi arrotondati.



**91 NC**

Bocca incasso con bordi arrotondati.



**91 NCF**

Bocca bordo vasca con angoli arrotondati.

## DOCCE



**J 31**

Miscelatore monocomando esterno doccia.



**J 39**

Miscelatore monocomando esterno doccia, con doccia duplex.



**317M 317DM**

Saliscendi minimale con doccetta anti-calcare.

## COLONNE DOCCIA



**J 35**

Gruppo doccia a muro.

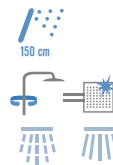

**J 37**

Miscelatore esterno doccia con deviatore integrato, con colonna saliscendi girevole, completo di doccetta anti-calcare con flessibile e soffione, il tutto in ottone cromato.



**J 37 B**

Miscelatore esterno doccia con deviatore integrato, con colonna saliscendi girevole, completo di doccetta anti-calcare con flessibile e soffione 356MD20 in abs cromato, Ø 20 cm.



X STYLE

MINIMAL

JAZZ

Q DESIGN

QUBIKA

S03

## CUCINA



**J 40**

Miscelatore monocomando per lavello, con bocca girevole.



**J 40 L**

Miscelatore monocomando per lavello, con bocca girevole.  
Altezza 415 mm, interasse 200 mm.



**J 47**

Miscelatore monocomando per lavello, con doccia estraibile in ottone cromato e bocca girevole.



**J 41**

Miscelatore monocomando per lavello a muro, con bocca girevole lunghezza 185 mm.

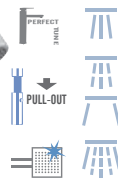

**J 48 319 M0**

Miscelatore monocomando bordo lavello con deviatore a leva integrato nella bocca minimale e doccetta cromata estraiibile a 2 funzioni con getti in silicone, idromassaggio ed anti-calcare.

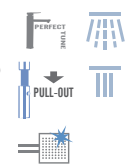

**J 48 332 EU**

Miscelatore monocomando bordo lavello con deviatore a leva integrato nella bocca minimale e doccetta estraibile a pulsante minimale in Abs cromata con impugnatura liscia 1/2".





# Q DESIGN

## CARATTERISTICHE TECNICHE:

La serie è dotata di cartuccia a dischi ceramici, Ø 25 mm, prodotta da S.T.S.R. - Studio Tecnico Sviluppo e Ricerche - [www.stsr.it](http://www.stsr.it)



# DESIGN MINIMALE

X STYLE

MINIMAL

JAZZ

Q DESIGN

QUBIKA

SQ3





Q DESIGN

**SIMBOLOGIE:**

 Con scarico con troppo pieno

 Senza scarico

 Con Click-Clack

 Con Click-Clack con Troppo Pieno

 Proporzione perfetta.

 Con Kit Doccia e flessibile lungo: 120, 150 o 200 cm

 Getto ad ampia copertura effetto pioggia

 Con getto a cascata

 Con multigetto.

 SOFFIONE SELF-CLEANING  
Soffione Anti-calcare ed Autopulente

 Ampio getto pioggia a risparmio idrico

 Corpo girevole

 Acqua Potabile

 Canna girevole

 Canna alta girevole

 Doccetta Anti-calcare

**LAVABI E BIDET**



**QD 10**  
Miscelatore monocomando lavabo con scarico quadrato.  
Altezza 140 mm, interasse 125 mm.



**QD 10 L**  
Miscelatore monocomando lavabo alto L con scarico click-clack.  
Altezza 230 mm, interasse 184 mm.



**QD 10 LXL**  
Miscelatore monocomando lavabo alto LXL con scarico click-clack.  
Altezza 280 mm, interasse 184 mm.



**QD 10 LXXL**  
Miscelatore monocomando lavabo alto XXL con scarico click-clack.  
Altezza 328 mm, interasse 184 mm.



**QD 11**  
Miscelatore monocomando lavabo senza scarico.  
Altezza 140 mm, interasse 125 mm.



**QD 11 L**  
Miscelatore monocomando lavabo alto L senza scarico.  
Altezza 230 mm, interasse 184 mm.



**QD 11 LXL**  
Miscelatore monocomando lavabo alto LXL senza scarico.  
Altezza 280 mm, interasse 184 mm.

**QD 12**  
Miscelatore monocomando lavabo senza scarico e senza foro sul corpo.  
Altezza 140 mm, interasse 125 mm.

 **NEW**



**QD 10 G**  
Miscelatore monocomando per lavabo con canna a "U" girevole e scarico click-clack.  
Altezza 280 mm, interasse 180 mm.

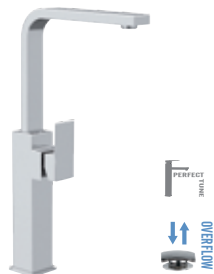

**QD 10 GL**  
Miscelatore monocomando alto per lavabo con canna a "U" girevole e scarico click-clack.  
Altezza 330 mm, interasse 155 mm.

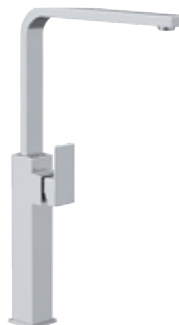

**QD 10 GLXL**  
Miscelatore monocomando alto per lavabo con canna lunga "U" girevole e scarico click-clack.  
Altezza 410 mm, interasse 220 mm.

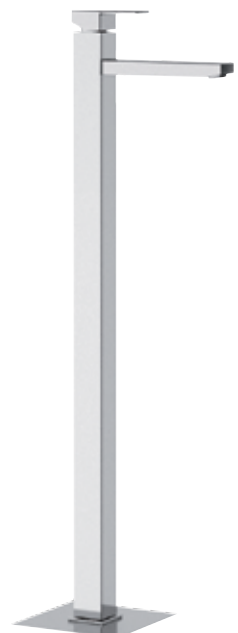

**QD 18**  
Miscelatore monocomando lavabo da pavimento con scarico click-clack.  
Altezza 1030 mm, interasse 170 mm.



X STYLE

MINIMAL

JAZZ

Q DESIGN

QUBIKA

S03



**QD 15 C**

Miscelatore lavabo da incasso, lunghezza bocca 18 cm.



**QD 15**

Miscelatore monocomando a incasso per lavabo, con piastra rettangolare, lunghezza bocca 18 cm.



**QD 20**

Miscelatore monocomando bidet con scarico quadrato.



**QD 15 P**

Miscelatore monocomando a incasso per lavabo, in ottone cromato, lunghezza bocca 18 cm.



**QD 14**

Miscelatore monocomando a incasso per lavabo, con piastra verticale rettangolare, lunghezza bocca 18 cm.



**QD 21**

Miscelatore monocomando bidet senza scarico.



## MISCELATORI VASCA



### Z 07

Miscelatore monocomando bordo vasca con deviatore integrato nella bocca e doccetta estraibile in ottone cromato.

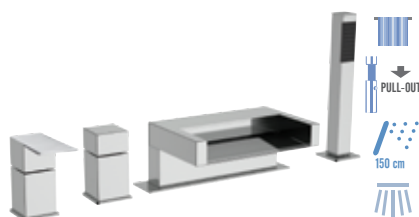

### ZC 06

Miscelatore monocomando bordo vasca con deviatore, doccetta estraibile in ottone cromato e bocca a cascata.

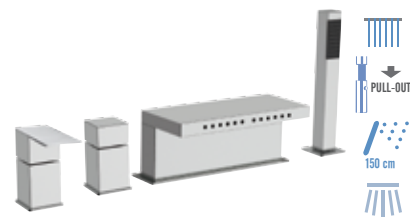

### Z 06

Miscelatore monocomando bordo vasca con deviatore, doccetta estraibile in ottone cromato e bocca multigetto.



**QD 02**  
Miscelatore vasca esterno con kit doccia, flessibile 150 cm e doccetta in ottone cromato.



**QD 03**  
Miscelatore monoforo lavabo/vasca, con deviatore e kit doccia, flessibile 150 cm e doccetta in ottone cromato.



**QD 05**  
Miscelatore vasca esterno senza kit doccia.



**QD 04**  
Miscelatore monocomando per vasca da incasso, su piastra in ottone cromato, flessibile 150 cm e doccetta in ottone cromato.



**QD 08**  
Miscelatore vasca da pavimento con deviatore e kit doccia, doccetta in ottone cromato. Altezza 900 mm, interasse 223 mm.

X STYLE

MINIMAL

JAZZ

Q DESIGN

QUBIKA

S03

## MISCELATORI DOCCIA



**QD 39**  
Monocomando doccia esterno con kit doccia, flessibile 150 cm e doccetta in ottone cromato.



**QD 31**  
Monocomando doccia esterno senza kit doccia.



**QD 35**  
Monocomando doccia esterno con attacco 3/4 M per colonna.



**317Q 317RR**  
Saliscendi e doccetta tutto in ottone serie ultrapiatta rettangolare minimale lusso.





## INCASSI DOCCIA



**QD 30**  
Miscelatore doccia incasso.



**QD 09**  
Miscelatore doccia incasso con deviatore.



**Z 92**  
Miscelatore monocomando per doccia con deviatore a 2 posizioni su piastra unica.



**Z 93**  
Miscelatore monocomando per doccia con deviatore a 3 vie e 3 posizioni (una entrata e tre uscite) su unica piastra.

**Z 93 7**  
Miscelatore monocomando per doccia con deviatore a tre vie e sette posizioni (una entrata, tre uscite e sette posizioni con cui selezionare uscite singole o miscelate tra loro) su unica piastra.



**Z 94**  
Miscelatore monocomando per doccia con deviatore a quattro vie (4 uscite ed 1 entrata) su piastra unica.

**Z 95**  
Miscelatore monocomando per doccia, con deviatore a 5 vie (5 uscite ed una entrata) su piastra singola.



## BOCCHIE

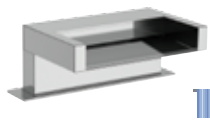

**91 ZCA**  
Bocca bordo vasca.

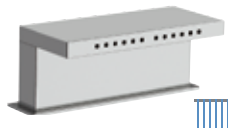

**91 ZCF**  
Bocca bordo vasca.



**91 ZC**  
Bocca incasso con getto a cascata.



**91 Q**  
Bocca incasso.



**91 QD**  
Bocca incasso con deviatore integrato.

X STYLE

MINIMAL

## COLONNE DOCCIA

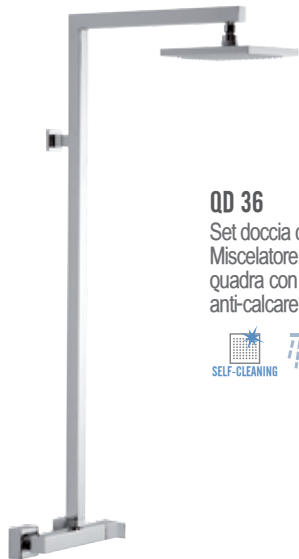

**QD 36**  
Set doccia composto da:  
Miscelatore esterno doccia QD35 con colonna doccia quadra con soffione completamente in ottone cromato e anti-calcare 359SS 20x20 cm.



**QD 37**  
Set doccia composto da:  
Miscelatore esterno doccia QD35 con colonna doccia quadra con saliscendi e deviatore, doccetta 317 SS in ottone cromato e soffione completamente in ottone 359SS 20x20 cm. Flessibile in ottone cromato incluso.



JAZZ

Q DESIGN

QUBIKA

S03

## CUCINA



**QD 40**  
Monocomando lavello con bocca girevole.



**QD 42 U**  
Miscelatore monocomando per lavello, con bocca alta girevole a "U" girevole.



## ELEGANT KITCHEN



**QK2 72**  
Monocomando lavello bocca girevole, corpo quadrato, serie Elegant Kitchen.



## ACQUA DEPURATA



**Q 40 DW**  
Miscelatore lavello a tre vie di ingresso, bocca girevole, con selezione acqua potabile tramite la leva, con due vie d'uscita completamente indipendenti.





# QUBIKA

## CARATTERISTICHE TECNICHE:

La serie è dotata di cartuccia a dischi ceramici, Ø 35 mm, prodotta da S.T.S.R. – Studio Tecnico Sviluppo e Ricerche - [www.stsr.it](http://www.stsr.it)  
Finiture disponibili: cromo, bianco opaco, nero opaco.

X STYLE

MINIMAL

JAZZ

Q DESIGN

QUBIKA

S03



**SIMBOLOGIE:**

**CR = cromato**
**BO = bianco opaco**
**NO = nero opaco**
**LAVABI**

**Q 10**

Miscelatore monocomando lavabo con scarico quadrato.  
Altezza 155 mm, interasse 130 mm.

**Q 11**

Miscelatore monocomando lavabo senza scarico.  
Altezza 155 mm, interasse 130 mm.

**Q 57**

Miscelatore monocomando lavabo due fori, senza scarico.

**Q 10 L**

Miscelatore monocomando lavabo alto L con scarico quadrato click-clack con troppo pieno.  
Altezza 315 mm, interasse 155 mm.

**Q 10 LB**

Miscelatore monocomando lavabo alto L con scarico click-clack quadrato.  
Altezza 315 mm, interasse 155 mm.

**Q 11 L**

Miscelatore monocomando lavabo alto L senza scarico.  
Altezza 315 mm, interasse 155 mm.

**Q 10 LXL**

Miscelatore monocomando lavabo extra alto XL con scarico quadrato click-clack con troppo pieno.  
Altezza 425 mm, interasse 155 mm.

**Q 11 LXL**

Miscelatore monocomando lavabo extra alto XL, senza scarico.  
Altezza 425 mm, interasse 155 mm.



## Q 15

Miscelatore monocomando a incasso per lavabo, con piastra rettangolare in ottone cromato e bocca qubika lunghezza cm 18.



## Q 14

Miscelatore monocomando a incasso per lavabo, con piastra verticale rettangolare in ottone cromato e bocca qubika lunghezza cm 18.

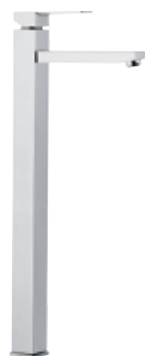

## Q 10 LXXL

Miscelatore monocomando lavabo extra alto XXL, con scarico click-clack quadrato con troppo pieno. Altezza 525 mm, interasse 155 mm.

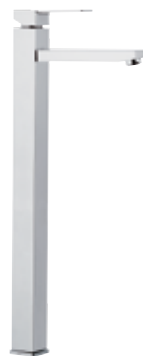

## Q 11 LXXL

Miscelatore monocomando lavabo extra alto XXL, senza scarico. Altezza 525 mm, interasse 155 mm.

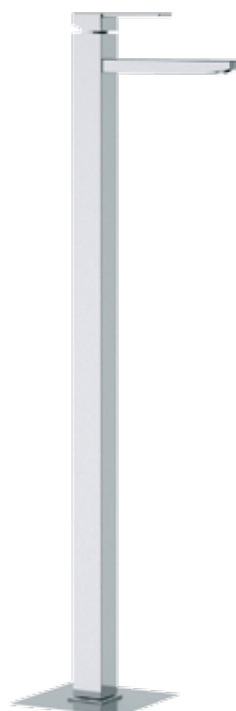

## Q 18

Miscelatore monocomando lavabo da pavimento, con scarico click-clack quadrato con troppo pieno. Altezza 1025 mm, interasse 170 mm.



## Q 10 G

Miscelatore monocomando lavabo, con canna corta a "U" e scarico click-clack quadrato con troppo pieno. Altezza 280 mm, interasse 180 mm.

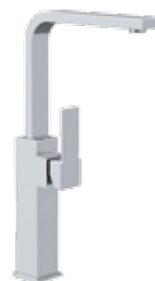

## Q 10 GL

Miscelatore monocomando lavabo alto L, con canna corta a "U", e scarico click-clack quadrato con troppo pieno. Altezza 330 mm, interasse 180 mm.

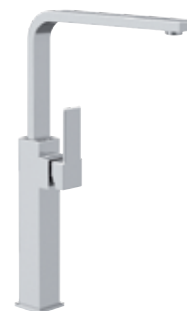

## Q 10 GLXL

Miscelatore monocomando lavabo alto XL, con canna lunga a "U" con scarico click-clack quadrato con troppo pieno. Altezza 410 mm, interasse 220 mm.

## LAVABO BOX INCASSO



## Q 15 KB

Miscelatore monocomando a incasso per lavabo, con piastra in ottone cromato da abbinare al box incasso.

NEW

+

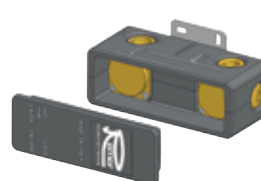

## RR BOX 15

Box da incasso per miscelatore monocomando a incasso per lavabo.

X STYLE

MINIMAL

JAZZ

Q DESIGN

QUBIKA

S03

## BIDET



**Q 20**

Miscelatore monocomando per bidet, con aeratore direzionabile, tettuccio di protezione.



**Q 21**

Miscelatore monocomando per bidet, con aeratore direzionabile, tettuccio di protezione, senza scarico.



**Q 23**

Miscelatore monocomando per bidet, con getto spray.



**Q 63**

Miscelatore incasso per shut-off.



**Q 60**

Miscelatore incasso per shut-off comprensivo di: doccetta shut-off ns art 332 OS, supporto doccia-presa acqua su piastra in ottone cromato e flessibile doccia cm 120.



**Q 10 SH**

Miscelatore monocomando lavabo con doccetta shut-off 332OS e scarico click-clack e troppo pieno.



**Q 65**

Miscelatore incasso per shut-off comprensivo di doccetta shut-off art. 332OS, supporto doccia-presa acqua, attacco conico da 1/2" e supporto shut-off, tutto in ottone cromato, flessibile doccia cm 120.



**Q 65 B**

Miscelatore incasso per shut-off su piastra in ottone cromato, attacco conico da 1/2" e supporto shut-off.

## VASCA



**Q 02**

Miscelatore monocomando per vasca, esterno, con doccia duplex.



**Q 03**

Miscelatore monoforo lavabo/vasca, con deviatore integrato e kit doccia.



**Q 05**

Miscelatore monocomando per vasca, esterno, senza set doccia.



**Q 04**

Miscelatore monocomando per vasca da incasso, su piastra rettangolare, con bocca lunga cm 18 con deviatore e kit doccia integrato.



**Q 08**

Miscelatore vasca da pavimento, con deviatore e kit doccia, senza scarico. altezza 900 mm, interasse 223 mm.





## Q 07

Miscelatore monocomando bordo vasca con deviatore integrato nella bocca quadra e doccetta quadrata estraibile in ottone cromato.

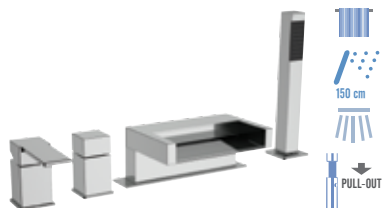

## QC 06

Miscelatore monocomando bordo vasca con deviatore, bocca cascata e doccetta estraibile in ottone cromato.



## Q 06

Miscelatore monocomando bordo vasca con deviatore, bocca con effetto multigetto e doccetta estraibile in ottone cromato.

X STYLE

MINIMAL

## INCASSI



## Q 09

Miscelatore monocomando da incasso con deviatore per vasca/doccia.

## N 09 B

Parte interna miscelatore monocomando incasso vasca/doccia con deviatore.

## Q 09 E

Parte esterna miscelatore monocomando incasso vasca/doccia con deviatore.



## Q 30

Miscelatore monocomando da incasso senza deviatore per doccia.

## N 30 B

Parte interna miscelatore monocomando incasso doccia.

## Q 30 E

Parte esterna miscelatore monocomando incasso doccia.



## Q 92

Miscelatore monocomando per doccia, con deviatore a due posizioni (due uscite ed una entrata) su piastra unica.



## Q 93

Miscelatore monocomando per doccia con deviatore a tre vie (una entrata e tre uscite) su unica piastra.

## Q 93 7

Miscelatore monocomando per doccia con deviatore a tre vie e sette posizioni (una entrata, tre uscite e sette posizioni con cui selezionare uscite singole o miscelate tra loro) su unica piastra.



## Q 94

Miscelatore monocomando per doccia, con deviatore a 4 posizioni (4 uscite ed 1 entrata) su piastra unica.

## Q 95

Miscelatore monocomando per doccia, con deviatore a 5 posizioni (5 uscite ed una entrata) su piastra singola su piastra singola.



## Q 94 C

Miscelatore monocomando per doccia, con deviatore a 4 posizioni (4 uscite ed una entrata) su doppia piastra, con possibilità di chiusura del flusso dal deviatore durante il cambio di posizione.

## Q 95 C

Miscelatore monocomando per doccia, con deviatore a 5 posizioni (5 uscite ed una entrata) su doppia piastra, con possibilità di chiusura del flusso dal deviatore durante il cambio di posizione.

JAZZ

Q DESIGN

QUBIKA

S03

## QUBIKA

## QUBIKA

*Il design di Qubika ha un carattere elegante ed una bellezza immediata. La base quadrata viene armonicamente intersecata dalle bocche rettangolari di spessore minimo. Ogni singolo componente si lega al precedente in un gioco di angoli vivi che scolpiscono l'oggetto e ne delineano le caratteristiche di essenzialità e forte impatto estetico. Una serie dalla modernità spiccata e minimale.*

*Il design della serie è stato ideato dal Gruppo di Ricerca e Sviluppo di Remer Rubinetterie ed ingegnerizzata e prodotta nei nostri stabilimenti produttivi situati in provincia di Milano.*

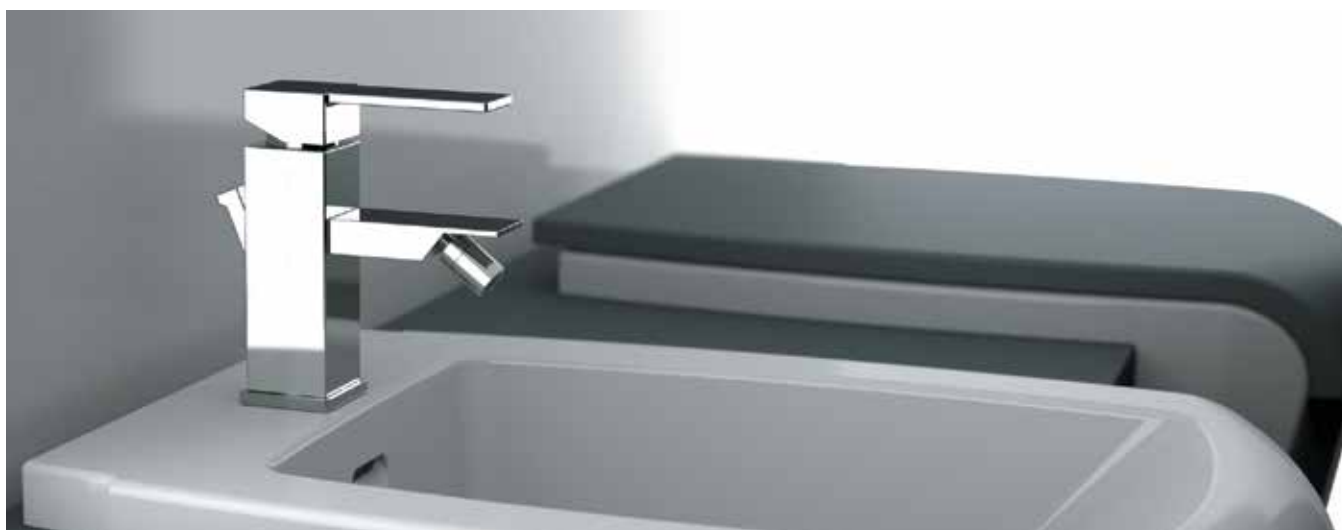



X STYLE

MINIMAL

JAZZ

Q DESIGN

QUBIKA

S03

## BOX INCASSO



**RR BOX**  
Box da incasso per miscelatore doccia con deviatore.



**Q 30 KB**  
Set miscelatore doccia da abbinare al box incasso.



**RR BOX**  
Box da incasso per miscelatore doccia con deviatore.

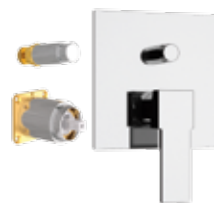

**Q 09 KB**  
Set miscelatore doccia con deviatore da abbinare al box incasso.



**RR BOX 93**  
Box da incasso per miscelatore doccia tre vie.



**Q 93 KB**  
Set miscelatore doccia tre vie da abbinare al box incasso.



**RR BOX 92**  
Box da incasso per miscelatore doccia due vie.



**Q 92 KB**  
Set miscelatore doccia due vie da abbinare al box incasso.



**RR BOX 93**  
Box da incasso per miscelatore doccia tre vie.



**Q 93 7 KB**  
Set miscelatore doccia tre vie e 7 posizioni da abbinare al box incasso.

## BOCCE



**91 Q**  
Bocca incasso serie Q, cm 18.



**91 QD**  
Bocca incasso serie Q, con deviatore integrato, cm 18.



**91 Q2**  
Bocca incasso lunghezza cm 18, interasse 16,5 cm.

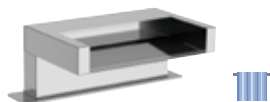

**91 ZCA**  
Bocca bordo vasca getto a cascata.



**91 ZCF**  
Bocca bordo vasca con effetto multigetto.

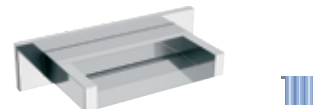

**91 ZC**  
Bocca a muro con getto cascata.

## DOCCE



### 317S 317SQ

Saliscendi quadro completamente in ottone con doccetta minimale SQ in abs cromato e flessibile conico in ottone cromato cm 150.



### Q 39

Miscelatore monocomando esterno per doccia, con doccia duplex.



### Q 35

Gruppo doccia a muro, con attacco superiore da 3/4" per colonna doccia.



### Q 31

Miscelatore monocomando esterno per doccia.

X STYLE

MINIMAL

JAZZ

Q DESIGN

QUBIKA

SQ3



### Q 36

Set doccia composto da: Miscelatore esterno doccia Q35 con colonna doccia quadra con soffione completamente in ottone cromato e anti-calcare 359SS 20x20 cm.



### Q 37

Set doccia composto da: Miscelatore esterno doccia Q35 con colonna doccia quadra con saliscendi e deviatore, doccetta 317 SQ in ABS e soffione completamente in ottone 359SS 20x20 cm. Flessibile in ottone cromato incluso.



### Q 37 XL

Set doccia composto da: Miscelatore esterno doccia Q35 con colonna doccia quadra con saliscendi e deviatore, doccetta 317SQ in ABS e soffione completamente in ottone cromato 359SS XL 35x35 cm. Flessibile in ottone cromato incluso.



## WELLNESS



Set doccia composto da:  
 Art. 357UFS 348Q: Soffione doccia ultra piatto in acciaio INOX lucidato a specchio con braccio doccia Q in ottone cromato.  
 Art. 317R 317RR: Saliscendi e doccetta tutto ottone serie ultrapiatta rettangolare minimale lusso con flessibile 333CN150 cm 150.  
 Art. 309 S: Presa acqua lusso quadrata.  
 Art. Q 09: Miscelatore incasso con deviatore.



ARTICOLO	DESCRIZIONE
Q 09 S01 UFS20	Con art. 357UFS20: 20x20 cm soffione doccia ultra piatto, con braccio doccia 30 cm.
Q 09 S01 UFS25	Con art. 357UFS25: 25x25 cm soffione doccia ultra piatto con braccio doccia 30 cm.
Q 09 S01 UFS30	Con art. 357UFS30: 30x30 cm soffione doccia ultra piatto con braccio doccia 30 cm.
Q 09 S01 UFS40	Con art. 357UFS40: 40x40 cm soffione doccia ultra piatto con braccio doccia 40 cm.



Set doccia composto da:  
 Art. 357UFS 348Q: Soffione doccia ultra piatto in acciaio INOX lucidato a specchio con braccio doccia Q in ottone cromato.  
 Art. 337S: Supporto doccia deluxe duplex con presa acqua.  
 Art. 317RR con 333CN150 con doccetta ultrapiatta e flessibile conico in ottone cromato cm 150.  
 Art. Q 09: Miscelatore incasso con deviatore



ARTICOLO	DESCRIZIONE
Q 09 S02 UFS20	Con art. 357UFS20: 20x20 cm soffione doccia ultra piatto con braccio doccia 30 cm.
Q 09 S02 UFS25	Con art. 357UFS25: 25x25 cm soffione doccia ultra piatto con braccio doccia 30 cm.
Q 09 S02 UFS30	Con art. 357UFS30: 30x30 cm soffione doccia ultra piatto con braccio doccia 30 cm.
Q 09 S02 UFS40	Con art. 357UFS40: 40x40 cm soffione doccia ultra piatto con braccio doccia 40 cm.



**Q 09 S21 UFS20**  
 Set doccia composto da:  
 Art. 357UFS20 347S 30: Soffione doccia ultra piatto in acciaio INOX lucidato a specchio con braccio doccia a soffitto in ottone cromato, cm 30.  
 Art. 317R 317RR: Saliscendi e doccetta tutto ottone serie ultrapiatta rettangolare minimale lusso con flessibile 333CN150 cm 150.  
 Art. 309 S: Presa acqua lusso quadrata.  
 Art. Q 09: Miscelatore incasso con deviatore.



**Q 09 S22 UFS20**  
 Set doccia composto da:  
 Art. 357UFS20 347S 30: Soffione doccia ultra piatto in acciaio INOX lucidato a specchio con braccio doccia a soffitto in ottone cromato, cm 30.  
 Art. 337S: Supporto doccia deluxe duplex con presa acqua.  
 Art. 317RR con 333CN150 con doccetta ultrapiatta e flessibile conico in ottone cromato cm 150.  
 Art. Q 09: Miscelatore incasso con deviatore.



**Q 93 7 S01 SSCA**  
 Set doccia composto da:  
 Art. 350 SS CA: Soffione doccia a parete in acciaio INOX lucidato a specchio, 2 getti, pioggia e cascata.  
 Art. 317R 317RR: Saliscendi e doccetta tutto ottone serie ultrapiatta rettangolare minimale lusso con flessibile 333CN150 cm 150.  
 Art. 309 S: Presa acqua lusso quadrata.  
 Art. Q 93 7: Miscelatore monocomando per doccia con deviatore a tre vie e 7 posizioni su piastra unica.



**Q 09 S01 SS**  
 Set doccia composto da:  
 Art. 350 SS: Soffione doccia a parete in acciaio INOX lucidato a specchio, getto pioggia.  
 Art. 317R 317RR: Saliscendi e doccetta tutto ottone serie ultrapiatta rettangolare minimale lusso con flessibile 333CN150 cm 150.  
 Art. 309 S: Presa acqua lusso quadrata.  
 Art. Q 09: Miscelatore incasso con deviatore.



**Q 93 7 S02 SSCA**  
 Set doccia composto da:  
 Art. 350 SS CA: Soffione doccia a parete in acciaio INOX lucidato a specchio, 2 getti, pioggia e cascata.  
 Art. 337S: Supporto doccia deluxe duplex con presa acqua.  
 Art. 317RR con 333CN150 con doccetta ultrapiatta e flessibile conico in ottone cromato cm 150.  
 Art. Q 93 7: Miscelatore monocomando per doccia con deviatore a tre vie e 7 posizioni su piastra unica.



**Q 09 S02 SS**  
 Set doccia composto da:  
 Art. 350 SS: Soffione doccia a parete in acciaio INOX lucidato a specchio, getto pioggia.  
 Art. 337S: Supporto doccia deluxe duplex con presa acqua.  
 Art. 317RR con 333CN150 con doccetta ultrapiatta e flessibile conico in ottone cromato cm 150.  
 Art. Q 09: Miscelatore incasso con deviatore.







Set doccia composto da:  
 Art. 357UFS 348Q: Soffione doccia ultra piatto in acciaio INOX lucidato a specchio con Braccio doccia Q in ottone cromato.  
 Art. 317R 317RR: Saliscendi e doccetta tutto ottone serie ultrapiatta rettangolare minimale lusso con flessibile 333CN150 cm 150.  
 Art. 309 S: Presa acqua lusso quadrata.  
 Art. Q 93 7: Miscelatore incasso con deviatore a tre vie e sette posizioni su piastra unica.  
 Art. Q 34 JET: 6 getti anti-calcare Q in ottone cromato.



ARTICOLO	DESCRIZIONE
<b>Q93 7 S01 UFS20</b>	Con art. 357UFS20: 20x20 cm soffione doccia ultra piatto, con braccio doccia 30 cm.
<b>Q93 7 S01 UFS25</b>	Con art. 357UFS25: 25x25 cm soffione doccia ultra piatto, con braccio doccia 30 cm.
<b>Q93 7 S01 UFS30</b>	Con art. 357UFS30: 30x30 cm soffione doccia ultra piatto, con braccio doccia 30 cm.
<b>Q93 7 S01 UFS40</b>	Con art. 357UFS40: 40x40 cm soffione doccia ultra piatto, con braccio doccia 40 cm.



Set doccia composto da:  
 Art. 357UFS 348Q: Soffione doccia ultra piatto in acciaio INOX lucidato a specchio con Braccio doccia Q in ottone cromato.  
 Art. 337S: Supporto doccia deluxe duplex con presa acqua.  
 Art. 317RR con 333CN150 con doccetta ultrapiatta e flessibile conico in ottone cromato cm 150.  
 Art. Q 93 7: Miscelatore incasso con deviatore a tre vie e sette posizioni su piastra unica.  
 Art. Q 34 JET: 6 getti anti-calcare Q in ottone cromato.



ARTICOLO	DESCRIZIONE
<b>Q93 7 S02 UFS20</b>	Con art. 357UFS20: 20x20 cm soffione doccia ultra piatto, con braccio doccia 30 cm.
<b>Q93 7 S02 UFS25</b>	Con art. 357UFS25: 25x25 cm soffione doccia ultra piatto, con braccio doccia 30 cm.
<b>Q93 7 S02 UFS30</b>	Con art. 357UFS30: 30x30 cm soffione doccia ultra piatto, con braccio doccia 30 cm.
<b>Q93 7 S02 UFS40</b>	Con art. 357UFS40: 40x40 cm soffione doccia ultra piatto, con braccio doccia 40 cm.



**Q93 7 S21 UFS20**  
 Set doccia composto da:  
 Art. 357UFS20 347S 30: Soffione doccia ultra piatto in acciaio INOX lucidato a specchio 20x20 cm con braccio a soffitto doccia in ottone cromato, cm 30.  
 Art. 317R 317RR: Saliscendi e doccetta tutto ottone serie ultrapiatta rettangolare minimale lusso con flessibile 333CN150 cm 150.  
 Art. 309 S: Presa acqua lusso quadrata.  
 Art. Q 93 7: Miscelatore incasso con deviatore a tre vie e sette posizioni su piastra unica.  
 Art. Q 34 JET: 6 getti anti-calcare Q in ottone cromato.



**Q93 7 S22 UFS20**  
 Set doccia composto da:  
 Art. 357UFS20 347S30: Soffione doccia ultra piatto in acciaio INOX lucidato a specchio 20x20 cm, con braccio doccia a soffitto in ottone cromato, cm 30.  
 Art. 337S: Supporto doccia deluxe duplex con presa acqua.  
 Art. 317RR con 333CN150 con doccetta ultrapiatta e flessibile conico in ottone cromato cm 150.  
 Art. Q 93 7: Miscelatore incasso con deviatore a tre vie e sette posizioni su piastra unica.  
 Art. Q 34 JET: 6 getti anti-calcare Q in ottone cromato.



**Q 94 S01 SSCA**  
 Set doccia composto da:  
 Art. 350 SS CA: Soffione doccia a parete in acciaio INOX lucidato a specchio, 2 getti, pioggia e cascata.  
 Art. 317R 317RR: Saliscendi e doccetta tutto ottone serie ultrapiatta rettangolare minimale lusso con flessibile 333CN150 cm 150.  
 Art. 309 S: Presa acqua lusso quadrata.  
 Art. Q 94: Miscelatore monocomando per doccia con deviatore a 4 posizioni (4 uscite ed 1 entrata) su piastra unica.  
 Art. Q 34 JET: 6 getti anti-calcare Q in ottone cromato.



**Q 93 7 S01 SS**  
 Set doccia composto da:  
 Art. 350 SS: Soffione doccia a parete in acciaio INOX lucidato a specchio, getto pioggia.  
 Art. 317R 317RR: Saliscendi e doccetta tutto ottone serie ultrapiatta rettangolare minimale lusso con flessibile 333CN150 cm 150.  
 Art. 309 S: Presa acqua lusso quadrata.  
 Art. Q 93 7: Miscelatore monocomando per doccia con deviatore a tre vie e sette posizioni su piastra unica.  
 Art. Q 34 JET: 6 getti anti-calcare Q in ottone cromato.



X STYLE

MINIMAL

JAZZ

Q DESIGN

QUBIKA

S03





X STYLE

MINIMAL

JAZZ

Q DESIGN

QUBIKA

S03



**Q 94 S02 SSCA**  
Set doccia composto da:  
Art. 350 SS CA: Soffione doccia a parete in acciaio INOX lucidato a specchio, 2 getti, pioggia e cascata.  
Art. 337S: Supporto doccia deluxe duplex con presa acqua.  
Art. 317RR con 333CN150 con doccetta ultrapiatta e flessibile conico in ottone cromato cm 150.  
Art. Q 94: Miscelatore monocomando per doccia con deviatore a tre vie e sette posizioni su piastra unica.  
Art. Q 34 JET: 6 getti anti-calcare Q in ottone cromato.



**Q 93 7 S02 SS**  
Set doccia composto da:  
Art. 350 SS: Soffione doccia a parete in acciaio INOX lucidato a specchio, getto pioggia.  
Art. 337S: Supporto doccia deluxe duplex con presa acqua.  
Art. 317RR con 333CN150 con doccetta ultrapiatta e flessibile conico in ottone cromato cm 150.  
Art. Q 93 7: Miscelatore monocomando per doccia con deviatore a tre vie e sette posizioni su piastra unica.  
Art. Q 34 JET: 6 getti anti-calcare Q in ottone cromato.



Set doccia composto da:  
Art. 359SS: Soffione SQ in ottone anti-calcare 20x20 cm.  
Braccio doccia quadrato in ottone cromato, cm 30.  
Art. 317S 317SQ: Saliscendi quadro con doccetta Q anti-calcare e flessibile conico in ottone cromato cm 150.  
Art. 309S: Presa acqua Q in ottone cromato.  
Art. Q 09: Miscelatore incasso con deviatore.



Set doccia composto da:  
Art. 359SS: Soffione SQ in ottone anti-calcare 20x20 cm.  
Braccio doccia quadrato in ottone cromato, cm 30.  
Art. 337S: Supporto doccia deluxe duplex con presa acqua.  
Art. 317SQ con 333CN150 con doccetta Q anti-calcare e flessibile conico in ottone cromato cm 150.  
Art. Q 09: Miscelatore incasso con deviatore.



ARTICOLO	DESCRIZIONE
<b>Q 09 S01</b>	Con art. 348S: braccio doccia a parete quadrato in ottone cromato, lunghezza 30 cm.
<b>Q 09 S21</b>	Con art. 347S: braccio doccia a soffito quadrato in ottone cromato, lunghezza 30 cm.

ARTICOLO	DESCRIZIONE
<b>Q 09 S02</b>	Con art. 348S: braccio doccia a parete quadrato in ottone cromato, lunghezza 30 cm.
<b>Q 09 S22</b>	Con art. 347S: braccio doccia a soffito quadrato in ottone cromato, lunghezza 30 cm.



Set doccia composto da:  
Art. 359SS: Soffione SQ in ottone anti-calcare 20x20 cm.  
Braccio doccia quadrato in ottone cromato, cm 30.  
Art. 317S 317SQ: saliscendi Q in ottone cromato con doccetta Q anti-calcare e flessibile conico in ottone cromato cm 150.  
Art. 309S: Presa acqua Q in ottone cromato.  
Art. Q 34 JET: 6 getti anti-calcare Q in ottone cromato.  
Art. Q 93 7: Miscelatore incasso con deviatore a tre vie e sette posizioni su piastra unica.



Set doccia composto da:  
Art. 359SS 348S: Soffione SQ in ottone anti-calcare 20x20 cm.  
Braccio doccia quadrato in ottone cromato, cm 30.  
Art. 337 S: Supporto doccia deluxe duplex con presa acqua.  
Art. 317SQ con 333CN 150: con doccetta Q anti-calcare e flessibile conico in ottone cromato cm 150.  
Art. Q 34 JET: 6 getti anti-calcare Q in ottone cromato.  
Art. Q 93 7: Miscelatore incasso con deviatore a tre vie e sette posizioni su piastra unica.



ARTICOLO	DESCRIZIONE
<b>Q 93 7 S01</b>	Con art. 348S: braccio doccia a parete quadrato in ottone cromato, lunghezza 30 cm.
<b>Q 93 7 S21</b>	Con art. 347S: braccio doccia a soffito quadrato in ottone cromato, lunghezza 30 cm.

ARTICOLO	DESCRIZIONE
<b>Q 93 7 S02</b>	Con art. 348S: braccio doccia a parete quadrato in ottone cromato, lunghezza 30 cm.
<b>Q 93 7 S22</b>	Con art. 347S: braccio doccia a soffito quadrato in ottone cromato, lunghezza 30 cm.



Set doccia composto da:  
 Art. 359SS: Soffione SQ in ottone anti-calcare 20x20 cm.  
 Braccio doccia quadrato in ottone cromato, cm 30.  
 Art. 339S 317SQ con 333CN 150: Supporto doccia cromato con doccetta Q anti-calcare e flessibile conico in ottone cromato cm 150.  
 Art. 91 QD: Bocca incasso Q con deviatore.  
 Art. Q 09: Miscelatore incasso con deviatore.



ARTICOLO	DESCRIZIONE
Q 09 S03	Con art. 348S: braccio doccia a parete quadrato in ottone cromato, lunghezza 30 cm.
Q 09 S23	Con art. 347S: braccio doccia a soffito quadrato in ottone cromato, lunghezza 30 cm.



## Q 30 S11

Set doccia composto da:  
 Art. 330S 359 SS 317SQ 333CN 150: Colonna doccia a barra quadrata, deluxe, con deviatore e saliscendi, soffione doccia quadrato in ottone con getti in silicone anti-calcare, doccetta serie Qubika anti-calcare, flessibile doccia conico in ottone.  
 Art. 330S RA: Presa acqua-attacco a muro quadrato.  
 Art. Q 30: Miscelatore incasso doccia Qubika.



X STYLE

MINIMAL

JAZZ

## CUCINA

## TOUCH-ME



### Q 40

Miscelatore monocomando per lavello, corpo quadrato girevole.



### Q 42 U

Miscelatore monocomando per lavello, con bocca alta girevole a "U".



### Q 41

Miscelatore monocomando esterno per lavello a muro con bocca squadrata lunghezza 200 mm.



### QT 42 U

Miscelatore monocomando per lavello, con bocca alta girevole a "U", dotata di tecnologia Touch-Me.



Q DESIGN

QUBIKA

S03

## BASSA PRESSIONE

## ACQUA POTABILE



### Q 40 BP

Miscelatore lavello quadrato con bocca girevole, per bassa pressione.



### Q 40 DW

Miscelatore lavello Quadrato a tre vie di ingresso con bocca girevole, con selezione acqua potabile tramite la leva, con due vie d'uscita completamente indipendenti.



### TTEQ 40 DW

Miscelatore lavello Quadrato a tre vie di ingresso con bocca girevole, con selezione acqua potabile tramite pulsante ad azionamento piezoelettrico alimentato a batteria, con due vie d'uscita completamente indipendenti.



# SQ3

## CARATTERISTICHE TECNICHE:

La serie è dotata di cartuccia a dischi ceramici, Ø 35 mm, prodotta da S.T.S.R. – Studio Tecnico Sviluppo e Ricerche - [www.stsr.it](http://www.stsr.it).  
Finiture disponibili: cromo, bianco opaco, nero opaco.



X STYLE

MINIMAL

JAZZ

Q DESIGN

QUBIKA

S03





**SIMBOLOGIE:**

- |  |                     |                                      |                                  |                       |  |                      |                     |  |  |
|--|---------------------|--------------------------------------|----------------------------------|-----------------------|--|----------------------|---------------------|--|--|
|  |                     |                                      |                                  |                       |  |                      |                     |  |  |
| Con scarico                              | Senza scarico       | Con Click-Clack                      | Con Click-Clack con Troppo Pieno | Proporzione perfetta. | Con Kit Doccia e flessibile lungo: 120, 150 o 200 cm | Con getto a cascata. | Con multigetto.     | Ampio getto pioggia a risparmio idrico | Getto ad ampia copertura effetto pioggia |
|  |                     |                                      |                                  |                       |  |                      |                     |  |  |
| Massaggio con getto vigoroso concentrato | Doccetta estraibile | Soffione Anti-calcare ed Autopulente | Getti Anti-calcare               | Getti Anti-calcare    | Corpo girevole                                       | Canna girevole       | Canna alta girevole | Acqua Potabile                         | Prodotto novità                          |
|  |                     | CR = cromato                         |                                  |                       | BO = bianco opaco                                    |                      |                     | NO = nero opaco                        |  |

**MANIGLIE:**

S 10 1



S 10 2



S 10 3



**LAVABI**

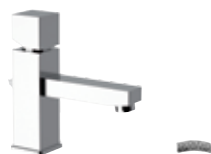

**S 10 3**

Miscelatore monocomando lavabo con scarico.  
Altezza 165 mm, interasse 130 mm.



**S 11 3**

Miscelatore monocomando lavabo senza scarico.  
Altezza 165 mm, interasse 130 mm.



**S 57 3**

Miscelatore monocomando lavabo due fori, senza scarico.





### S 10 L 3

Miscelatore monocomando lavabo alto L, con scarico click-clack con troppo pieno. Altezza 315 mm, interasse 155 mm.



### S 10 LB 3

Miscelatore monocomando lavabo alto L, con click-clack. Altezza 315 mm, interasse 155 mm.



### S 11 L 3

Miscelatore monocomando lavabo alto L, senza scarico. Altezza 315 mm, interasse 155 mm.



### S 14 3

Miscelatore monocomando a incasso per lavabo, con piastra verticale rettangolare in ottone cromato e bocca quadrata 18 cm.

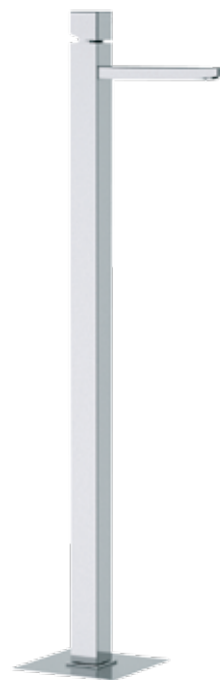

### S 18 3

Miscelatore monocomando lavabo da terra, scarico click-clack con troppo pieno. Altezza 1035 mm, interasse 170 mm.



### S 10 G 3

Miscelatore monocomando per lavabo, con canna corta, scarico click-clack con troppo pieno. Altezza 280 mm, interasse 180 mm.



### S 10 GL 3

Miscelatore monocomando alto per lavabo, con canna corta, scarico click-clack con troppo pieno. Altezza 330 mm, interasse 180 mm.

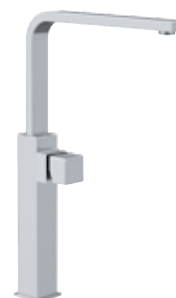

### S 10 GLXL 3

Miscelatore monocomando alto per lavabo, con canna lunga a "U", scarico click-clack con troppo pieno. Altezza 410 mm, interasse 220 mm.



X STYLE

MINIMAL

JAZZ

Q DESIGN

QUBIKA

S03

## LAVABO BOX INCASSO



### S 15 3

CR € 313,90 BO-NO € 502,30

Miscelatore monocomando a incasso per lavabo, con piastra rettangolare in ottone cromato e bocca quadrata 18 cm.



### S 15 3 KB

Miscelatore monocomando a incasso per lavabo, con piastra in ottone cromato da abbinare al box incasso.

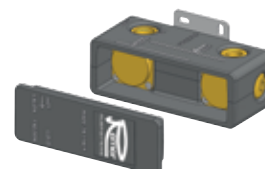

### RR BOX 15

Box da incasso per miscelatore monocomando a incasso per lavabo.

## BIDET



### S 20 3

Miscelatore monocomando per bidet, con aeratore direzionabile con scarico.



### S 21 3

Miscelatore monocomando per bidet, con aeratore direzionabile, senza scarico.

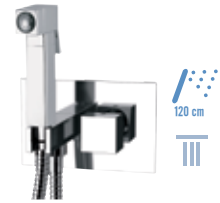

### S 60 3

Set miscelatore incasso shut-off con flessibile doccia cm 120.



### S 63 3

Miscelatore incasso per shut-off.

## VASCA



### S 02 3

Miscelatore monocomando per vasca, esterno, con doccia duplex.



### S 05 3

Miscelatore monocomando per vasca, esterno, senza set doccia.



### S 04 3

Miscelatore monocomando per vasca da incasso, su piastra rettangolare, con bocca lunga cm 18, deviatore e kit doccia integrato.



### S 07 3

Miscelatore monocomando bordo vasca con bocca quadra, deviatore integrato nella bocca e doccetta quadrata estraibile in ottone cromato.



### S 06 3

Miscelatore monocomando bordo vasca con deviatore, bocca con effetto multigetto e doccetta estraibile in ottone cromato.

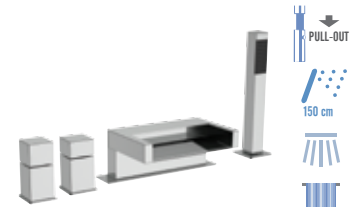

### SC 06 3

Miscelatore monocomando bordo vasca con deviatore, bocca cascata e doccetta estraibile in ottone cromato.

## DOCCE



### S 31 3

Miscelatore monocomando esterno per doccia.



### S 39 3

Miscelatore monocomando esterno per doccia, con doccia duplex.



### 317S 317DS

Saliscendi SQ completamente in ottone con doccetta minimale SQ in abs cromato.



X STYLE

MINIMAL

JAZZ

Q DESIGN

QUBIKA

SQ3

## INCASSI



### S 09 3

Miscelatore monocomando da incasso con deviatore per vasca/doccia.

### N 09 B

Parte interna miscelatore monocomando incasso vasca/doccia con deviatore.

### S 09 3 E

Parte esterna miscelatore monocomando incasso vasca/doccia con deviatore.



### S 30 3

Miscelatore monocomando da incasso senza deviatore per vasca/doccia.

### N 30 B

Parte interna miscelatore monocomando incasso doccia.

### S 30 3 E

Parte esterna miscelatore monocomando incasso doccia.



### S 92 3

Miscelatore monocomando per doccia, con deviatore a 2 posizioni (2 uscite ed 1 entrata) su piastra unica.



### S 93 3

Miscelatore monocomando per doccia con deviatore a 3 vie (1 entrata e 3 uscite) su unica piastra.

### S 93 7 3

Miscelatore monocomando per doccia con deviatore a tre vie e sette posizioni (una entrata, tre uscite e sette posizioni con cui selezionare uscite singole o miscelate tra loro) su unica piastra.



### S 94 3

Miscelatore monocomando per doccia, con deviatore a 4 posizioni (4 uscite ed 1 entrata) su piastra unica.

### S 95 3

Miscelatore monocomando per doccia, con deviatore a 5 posizioni (5 uscite ed 1 entrata) su piastra singola.



### S 94 C 3

Miscelatore monocomando per doccia, con deviatore a 4 posizioni (4 uscite ed 1 entrata) su doppia piastra, con possibilità di chiusura del flusso dal deviatore durante il cambio di posizione.

### S 95 C 3

Miscelatore monocomando per doccia, con deviatore a 5 posizioni (5 uscite ed 1 entrata) su doppia piastra, con possibilità di chiusura del flusso dal deviatore durante il cambio di posizione.



SQ3

## BOX INCASSO



NEW

+



### RR BOX

Box da incasso per miscelatore doccia con deviatore.

### S 30 3 KB

Set miscelatore doccia da abbinare al box incasso.



+



### RR BOX

Box da incasso per miscelatore doccia con deviatore.

### S 09 3 KB

Set miscelatore doccia con deviatore da abbinare al box incasso.



NEW

+



### RR BOX 93

Box da incasso per miscelatore doccia tre vie.

### S 93 3 KB

Set miscelatore doccia tre vie da abbinare al box incasso.



NEW

+



### RR BOX 92

Box da incasso per miscelatore doccia due vie.

### S 92 3 KB

Set miscelatore doccia due vie da abbinare al box incasso.



NEW

+



### RR BOX 93

Box da incasso per miscelatore doccia tre vie.

### S 93 7 3 KB

Set miscelatore doccia tre vie e 7 posizioni da abbinare al box incasso.

## BOCCE



### 91 S

Bocca incasso per miscelatore vasca-doccia, cm 18.



### 91 SD

Bocca incasso per miscelatore vasca-doccia, cm 18, con deviatore integrato.

## WELLNESS



### S 09 3 S02

Set doccia composto da:  
 Art. 359SS 348S30: Soffione SQ in ottone cromato 20x20 cm anti-calcare con braccio quadro in ottone cm 30.  
 Art. 337S: Supporto doccia deluxe duplex con presa acqua in ottone cromato.  
 Art. 317SS con 333CN150: con doccetta in ottone cromato anti-calcare e flessibile conico in ottone cromato cm 150.  
 Art. S 09 3: Miscelatore incasso con deviatore.



### S 93 7 3 S01

Set doccia composto da:  
 Art. 359SS 348S30: Soffione SQ in ottone cromato 20x20 cm anti-calcare con braccio quadro in ottone cm 30.  
 Art. 317S 317SS: Saliscendi quadro con doccetta in ottone cromato e flessibile conico in ottone cromato.  
 Art. 309S: Presa acqua Q in ottone cromato.  
 Art. Q 34 JET: 6 getti anti-calcare Q in ottone cromato.  
 Art. S 93 7 3: Miscelatore incasso con deviatore a tre vie e sette posizioni su piastra unica.







## S 93 7 3 S02

Set doccia composto da:  
 Art. 359SS 348S30: Soffione SQ in ottone cromato 20x20 cm anti-calcare con braccio quadro in ottone cm 30.  
 Art. 337 S: Supporto doccia deluxe duplex con presa acqua.  
 Art. 317SS con 333CN 150: con doccetta in ottone cromato anti-calcare e flessibile conico in ottone cromato cm 150.  
 Art. Q 34 JET: 6 getti anti-calcare Q in ottone cromato.  
 Art. S 93 7 3: Miscelatore incasso con deviatore a tre vie e sette posizioni su piastra unica.



## S 93 7 3 S03

Set doccia composto da:  
 Art. 359SS 348S30: Soffione SQ in ottone cromato 20x20 cm anti-calcare con braccio quadro in ottone cm 30.  
 Art. 337 S: Supporto doccia deluxe duplex con presa acqua.  
 Art. 317SS con 333CN 150: con doccetta in ottone cromato anti-calcare e flessibile conico in ottone cromato cm 150.  
 Art. 91 S : Bocca incasso serie S.  
 Art. S 93 7 3: Miscelatore incasso con deviatore a tre vie e sette posizioni su piastra unica.



X STYLE

MINIMAL

JAZZ

Q DESIGN

QUBIKA

S03



## CUCINA



### S 40 3

Miscelatore monocomando per lavello, corpo quadrato girevole.



### S 42 3U

Miscelatore monocomando per lavello, con bocca girevole ad "U".

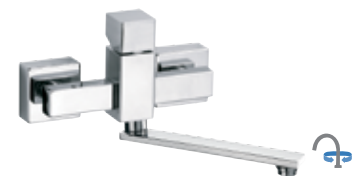

### S 41 3

Miscelatore monocomando esterno per lavello a muro con bocca squadrata 20 cm.





# PROGRAMMA ECO

## Design e tecnologia ambientale

La cartuccia ECO nasce per il controllo dei consumi per un reale risparmio sia economico che ambientale. Questo grazie alla possibilità di abbinare differenti tecnologie quali:  
**ENERGY SAVING:** si ottiene utilizzando una specifica cartuccia che permette di aprire in sola acqua fredda quando la leva si trova in posizione allineata rispetto alla bocca del rubinetto. Questa nuova cartuccia evita la richiesta indesiderata di acqua calda, permettendo perciò un risparmio energetico.

**ANTISCALDING:** si ottiene applicando una speciale ghiera sulla cartuccia. Questa permette, previa regolazione durante l'installazione, la limitazione della temperatura massima erogabile, impedendo la completa rotazione della maniglia verso l'acqua calda. L'impostazione "di fabbrica" della ghiera è in posizione neutra. (optional combinabile alla tecnologia precedente).

**WATER SAVING DYNAMIC:** la tecnologia di limitazione dinamica della portata dell'acqua si attua tramite un sistema che permette di percepire una leggera limitazione all'apertura della leva esclusivamente intorno al 50% dell'erogazione massima d'acqua del miscelatore e risulta essere un invito all'utente a non aprire completamente il flusso dell'acqua quando non strettamente necessario riducendo i consumi. L'ulteriore erogazione fino al 100% del flusso rimane comunque e sempre possibile con la costante morbidezza della leva una volta superata questa leggera resistenza. (optional combinabili alle tecnologie precedenti).

**AERATORE CON EROGAZIONE 8 LITRI AL MINUTO**  
(6, 4, 3 litri al minuto in alternativa).

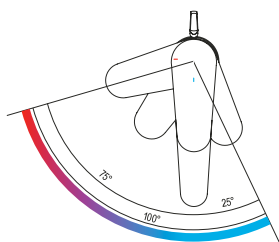

### STANDARD ECO



**ENERGY SAVING**



**WATER SAVING**



**COD. 83L8**  
STANDARD 8 L/min

OPTIONS:

3 L/MIN  
4 L/MIN  
6 L/MIN

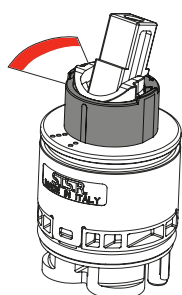

### OPTIONAL ECO



**ANTISCALDING**



**WATER SAVING DYNAMIC**

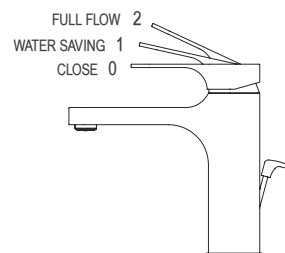

# TUTTA LA FORZA DEL MADE IN ITALY

## CLASS LINE ECO

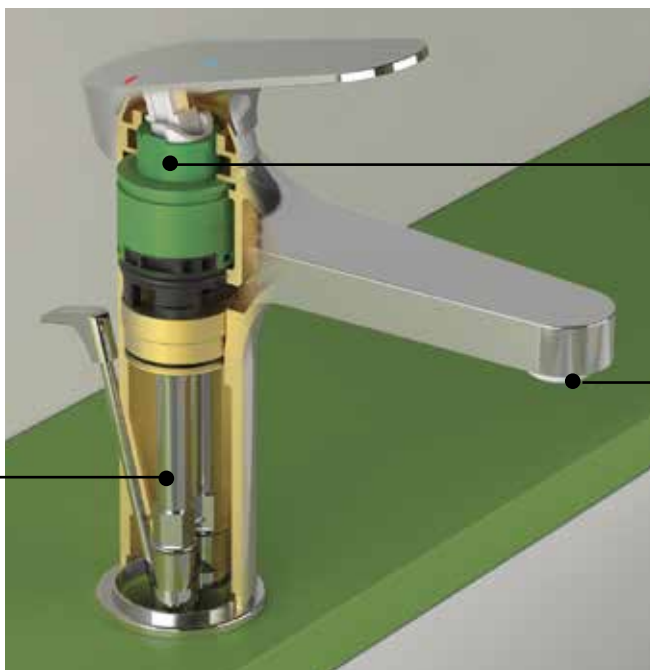

CARTUCCIA MADE IN ITALY  
TECNOLOGICA REALIZZATA  
CON PLASTICA  
ALIMENTARE

AERATORE A  
RISPARMIO IDRICO

FLESSIBILI MADE IN ITALY,  
IN GOMMA ALIMENTARE EPDM,  
RACCORDATI CON  
MACCHINE AUTOMATICHE

CLASS LINE ECO

WINNER ECO

La serie Eco viene proposta in una gamma di articoli in cui la tecnologia Eco trova migliori benefici nell'uso.

Gli articoli doccia e vasca non sono stati proposti in quanto si presuppone che non vi sia la necessità di apertura in acqua fredda in quanto gli ambienti vasca e

doccia sono generalmente utilizzati per loro natura con acqua miscelata/calda. Per completare la gamma Eco con gli articoli vasca/doccia si consiglia di utilizzare la serie nella versione cartuccia standard.

Le versioni eco vasca e doccia sono comunque disponibili a richiesta.

## WINNER ECO



CARTUCCIA MADE IN ITALY  
TECNOLOGICA REALIZZATA  
CON PLASTICA ALIMENTARE

AERATORE A  
RISPARMIO IDRICO

FLESSIBILI MADE IN ITALY,  
IN GOMMA ALIMENTARE EPDM,  
RACCORDATI CON MACCHINE  
AUTOMATICHE

# CLASS LINE ECO



## CARATTERISTICHE TECNICHE:

La serie è dotata di cartuccia a dischi ceramici, Ø 35 mm, prodotta da S.T.S.R. - Studio Tecnico Sviluppo e Ricerche - [www.stsr.it](http://www.stsr.it)

ECO

CLASS LINE ECO

WINNER ECO



**SIMBOLOGIE:**

- |   |  |   |   |   |   |   |  |   |  |
|---|--|---|---|---|---|---|--|---|--|
| <br>Con scarico con troppo pieno | <br>Senza scarico | <br>Con Click-Clack con Troppo Pieno | <br>Proporzione perfetta.                | <br>Con Kit Doccia e flessibile lungo: 120, 150 o 200 cm | <br>Doccetta Anticalcare                           | <br>Lavello sottofinestra con canna girevole | <br>Canna alta girevole | <br>Canna girevole                           |  |
| <br>Eco                          | <br>Energy Saving | <br>Risparmio Idrico 8L/min.         | <br>Limitatore di Temperatura (optional) | <br>Risparmio Idrico Dinamico (optional)                 | <br>Getto con massaggio intenso a risparmio idrico | <br>Getto aerato intenso                     | <br>Getto Esterno       | <br>Massaggio con getto vigoroso concentrato | <br>Getto spray delicato ad ampia copertura con getto vigoroso all'esterno a risparmio idrico |

 **LAVABI ECO**



**LE 10 LT8**

Miscelatore monocomando lavabo con scarico.  
Altezza 150 mm, interasse 110 cm.



**LE 10L LT8**

Miscelatore monocomando lavabo alto L con scarico.  
Altezza 170 mm, interasse 130 cm.



**LE 10LXL LT8**

Miscelatore monocomando lavabo alto XL, con click-clack con troppo pieno.  
Altezza 306 mm, interasse 180 cm.

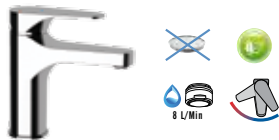

**LE 11 LT8**

Miscelatore monocomando lavabo, senza scarico.  
Altezza 150 mm, interasse 110 cm.

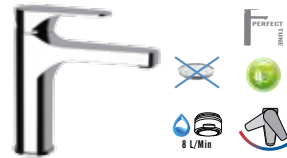

**LE 11L LT8**

Miscelatore monocomando lavabo alto L, senza scarico.  
Altezza 170 mm, interasse 130 cm.



**LE 11LXL LT8**

Miscelatore monocomando lavabo alto XL, senza scarico.  
Altezza 306 mm, interasse 180 cm.

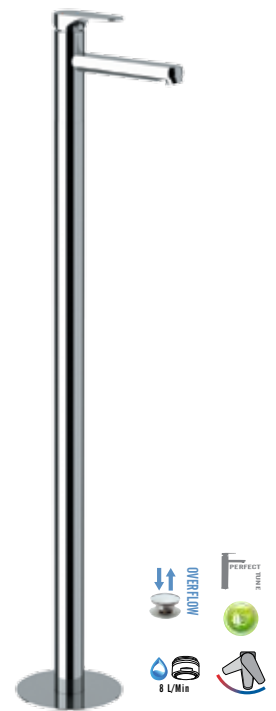

**LE 18 LT8**

Miscelatore monocomando lavabo da terra, con scarico click-clack con troppo pieno.  
Altezza 1020 mm, interasse 168 cm.

**LE 12 LT8**

Miscelatore monocomando lavabo senza scarico e senza foro sul corpo.  
Altezza 150 mm, interasse 110 cm.



**LE 15 LT8**

Miscelatore monocomando a incasso per lavabo, con piastra rettangolare in ottone cromato e bocca lunghezza cm 18.



**LE 14 LT8**

Miscelatore monocomando a incasso per lavabo, con piastra verticale in ottone cromato e bocca lunghezza cm 18.



 **BIDET ECO**



**LE 20 LT8**  
Miscelatore monocomando bidet con scarico.



**LE 21 LT8**  
Miscelatore monocomando bidet, senza scarico.



**LE 65 LT8**  
Miscelatore incasso per shut-off comprensivo di: doccetta shut-off art. 332OL, supporto doccia-presa acqua su piastra in ottone cromato e flessibile doccia cm 120.

 **CUCINA ECO**



**LE 72 LT8**  
Miscelatore monocomando monoforo 90°, con bocca alta girevole a "U".



**LE 72 C LT8**  
Miscelatore monocomando per lavello, con canna corta girevole tipo lusso.



**LE 42 LT8**  
Miscelatore monocomando per lavello, con bocca alta girevole tipo lusso.



**LE 42 C LT8**  
Miscelatore monocomando per lavello, con canna corta girevole, tipo lusso.



**LE 42 U LT8**  
Miscelatore monocomando per lavello, con bocca girevole a "U".



**LE 41 LT8**  
Miscelatore monocomando per lavello a muro con canna girevole 20 cm..



**LE 41 S LT8**  
Miscelatore monocomando per lavello a muro, con bocca a "S" con canna girevole 21 cm.



**LE 40 LT8**  
Miscelatore monocomando per lavello con canna girevole.



**LE 42 R LT8**  
Miscelatore monocomando monoforo 90° per lavello, con bocca alta girevole ed orientabile, tipo lusso, modello sottofinestra.



**LE 49 LT8**  
Miscelatore lavabo/vasca con canna fusa lunga 30 cm, deviatore e kit doccia con doccetta minimale a 4 funzioni.



**LE 46 LT8**  
Miscelatore lavabo/vasca con canna fusa lunga 30 cm e deviatore senza kit doccia.

# WINNER ECO



## CARATTERISTICHE TECNICHE:

La serie è dotata di cartuccia a dischi ceramici, Ø 35 mm, prodotta da S.T.S.R. – Studio Tecnico Sviluppo e Ricerche - [www.stsr.it](http://www.stsr.it)

ECO

CLASS LINE ECO

WINNER ECO





**SIMBOLOGIE:**

-  Con scarico con troppo pieno
-  Senza scarico
-  Con Click-Clack con Troppo Pieno
-  Proporzione perfetta.
-  Con Kit Doccia e flessibile lungo: 120, 150 o 200 cm
-  Lavello sottofinestra con canna girevole
-  Canna alta girevole
-  Canna girevole
-  Eco
-  Energy Saving
-  Risparmio Idrico 8L/min.
-  Limitatore di Temperatura (optional)
-  Risparmio Idrico Dinamico (optional)
-  Prodotto novità

**LAVABI ECO**



**WE 10 LT8**

Miscelatore monocomando lavabo con scarico. Altezza 150 mm, interasse 95 mm.



**WE 10L LT8**

Miscelatore monocomando lavabo, con scarico click-clack con troppo pieno. Altezza 305 mm, interasse 182 mm.

CR € 206,20



**WE 15 LT8**

Miscelatore monocomando a incasso per lavabo, con piastra rettangolare in ottone cromato e canna lunga 18 cm.



**WE 11 LT8**

Miscelatore monocomando lavabo senza scarico. Altezza 150 mm, interasse 95 mm.



**WE 11L LT8**

Miscelatore monocomando lavabo senza scarico. Altezza 305 mm, interasse 182 mm.

**WE 12 LT8**

Miscelatore monocomando lavabo senza scarico e senza foro sul corpo. Altezza 150 mm, interasse 95 mm.



**BIDET ECO**



**WE 20 LT8**  
Miscelatore monocomando bidet con scarico.



**WE 21 LT8**  
Miscelatore monocomando bidet senza scarico.



**WE 65 LT8**  
Miscelatore incasso per shut-off comprensivo di: doccetta shut-off art. 332OL, supporto doccia-presa acqua su piastra in ottone cromato e flessibile doccia cm 120.



**CUCINA ECO**



**WE 72 LT8**  
Miscelatore monocomando monoforo 90°, con canna alta girevole a "U".



**WE 72 C LT8**  
Miscelatore monocomando per lavello, con canna corta girevole a "U", tipo lusso.



**WE 41 LT8**  
Miscelatore monocomando per lavello a muro con canna girevole 20 cm.



**WE 42 LT8**  
Miscelatore monocomando per lavello, con bocca alta girevole.



**WE 42 C LT8**  
Miscelatore monocomando per lavello, canna corta girevole, tipo lusso.



**WE 42 R LT8**  
Miscelatore monocomando monoforo 90° per lavello, con bocca alta girevole ed orientabile, tipo lusso, modello sottofinestra.



# ELEGANCE

## CARATTERISTICHE TECNICHE:

La serie è dotata di cartuccia termostatica prodotta da S.T.S.R. – Studio Tecnico Sviluppo e Ricerche [www.stsr.it](http://www.stsr.it).  
Finiture disponibili: cromo



ELEGANCE

Q-ELEGANCE

MINIMAL THERMO

QUBIKA THERMO

THERMO





L'utilizzo dei modelli termostatici può aiutare ad avere un maggiore controllo sul consumo di acqua e energia, risparmiando la quantità di acqua solitamente sprecata cercando la temperatura desiderata.

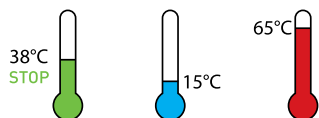

#### CARATTERISTICHE TECNICHE:

- Blocco di sicurezza: 38°C
- Campo di lavoro: da 15°C a 65°C
- Differenziale termico consigliato 50°C
- Campo di pressione in rete: da 1 a 5 bar dinamici
- Sistema di sicurezza con blocco dell'erogazione in caso di mancanza di una delle due acque
- Filtro in acciaio INOX per il trattamento delle impurità

#### SIMBOLOGIE:



Termostatico



Con Kit Doccia e flessibile lungo: 120, 150 o 200 cm



Doccetta Anticalcare



Soffione Autopulente



Colonna doccia girevole.



Colonna doccia girevole e telescopica.



Prodotto novità



Getto con massaggio intenso a risparmio idrico



Getto Esterno



Getto vigoroso concentrato e getto esterno



Getto aerato intenso



Getto ad ampia copertura effetto pioggia



Getto spray delicato ad ampia copertura con getto vigoroso all'esterno a risparmio idrico



Ampia getto pioggia a risparmio idrico



Getto soft aerato misciato ad un getto vigoroso a risparmio idrico

## GRUPPI VASCA E DOCCIA TERMOSTATICI



EQ 02

Miscelatore termostatico esterno vasca completo di kit duplex.



EQ 05

Miscelatore termostatico esterno vasca senza kit doccia.



EQ 31

Miscelatore esterno doccia termostatico con attacco inferiore da 1/2".



EQ 32

Miscelatore esterno doccia termostatico con deviatore incorporato, attacco alto da 1/2" ed attacco inferiore da 1/2".

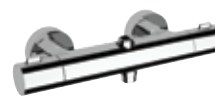

EQ 32 34

Miscelatore esterno doccia termostatico con deviatore incorporato, attacco alto 3/4" ed attacco inferiore da 1/2".



## COLONNE DOCCIA TERMOSTATICHE



**EQ 37 330U**

Set doccia composto da: Miscelatore termostatico esterno doccia EQ32 con colonna doccia deluxe con saliscendi e deviatore, doccetta anticalcare in ottone cromato 317MM e soffione in ottone cromato e anticalcare 359MM20. Flessibile in ottone cromato incluso.



**EQ 37 330L**

Set doccia composto da: Miscelatore termostatico esterno doccia EQ32 con colonna doccia con saliscendi e deviatore, doccetta anticalcare in ottone cromato 317MM e soffione in ottone cromato e anticalcare 359MM20. Flessibile in ottone cromato incluso.



**EQ 37 330N**

Set doccia composto da: Miscelatore termostatico esterno doccia EQ32 con colonna doccia minimale con saliscendi e deviatore, doccetta anticalcare in abs cromato 317DM e soffione in abs cromato e anticalcare 356MD25 Ø 25 cm. Flessibile in ottone cromato incluso.



**EQ 37 330FG**

Set doccia composto da: Miscelatore termostatico esterno doccia EQ32 con colonna doccia minimale con saliscendi e deviatore, doccetta anticalcare a 4 funzioni e soffione in abs cromato e anticalcare 356MD25 Ø 25 cm. Flessibile in ottone cromato incluso.

ELEGANCE

Q-ELEGANCE

MINIMAL THERMO

QUBIKA THERMO

THERMO



**EQ 32 AUFM20**

Miscelatore doccia termostatico con attacco superiore da 3/4" ed attacco inferiore da 1/2" con deviatore integrato, colonna doccia telescopica, doccetta anticalcare a 4 funzioni, con flessibile 333 CNX 150 cm e soffione ultrapiatto Ø 20 cm, in acciaio INOX lucidato a specchio.



**EQ 32 AUFM25**

Miscelatore doccia termostatico con attacco superiore da 3/4" ed attacco inferiore da 1/2" con deviatore integrato, colonna doccia telescopica, doccetta anticalcare a 4 funzioni, con flessibile 333 CNX 150 cm e soffione ultrapiatto Ø 25 cm, in acciaio INOX lucidato a specchio.



**EQ 32 A8CP UFD20**

Miscelatore doccia termostatico con attacco superiore da 3/4" ed attacco inferiore da 1/2" con deviatore integrato, colonna doccia telescopica, doccetta anticalcare a 4 funzioni, con pulsante per il cambio dei getti e flessibile 333 CNX 150 cm e soffione ultrapiatto con angoli arrotondati 20x20 cm, in acciaio INOX lucidato a specchio.



**EQ 32 A8CP UFD25**

Miscelatore doccia termostatico con attacco superiore da 3/4" ed attacco inferiore da 1/2" con deviatore integrato, colonna doccia telescopica, doccetta anticalcare a 4 funzioni, con pulsante per il cambio dei getti e flessibile 333 CNX 150 cm e soffione ultrapiatto con angoli arrotondati 25x25 cm, in acciaio INOX lucidato a specchio.



**EQ 32 AEC20**

Miscelatore doccia termostatico con attacco superiore da 3/4" ed attacco inferiore da 1/2" con deviatore integrato, colonna doccia telescopica, doccetta anticalcare a 4 funzioni, con flessibile 333 CNX 150 cm e soffione a pioggia, in ABS cromato, Ø 20 cm, con getti in silicone anticalcare.



**EQ 32 AMD20**

Miscelatore doccia termostatico con attacco superiore da 3/4" ed attacco inferiore da 1/2" con deviatore integrato, colonna doccia telescopica, doccetta anticalcare a 4 funzioni, con flessibile 333 CNX 150 cm e soffione lusso a pioggia, in ABS cromato, Ø 20 cm, con getti in silicone anticalcare.



**EQ 32 A8CP AD20**

Miscelatore doccia termostatico con attacco superiore da 3/4" ed attacco inferiore da 1/2" con deviatore integrato, colonna doccia telescopica, doccetta anticalcare a 4 funzioni, con pulsante per il cambio dei getti e flessibile 333 CNX 150 cm e soffione a pioggia squadrato con angoli arrotondati, in ABS cromato, 20x20 cm, con getti in silicone anticalcare.

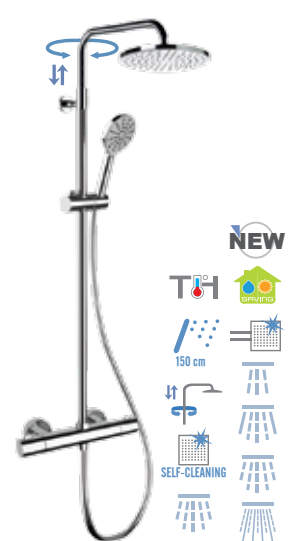

**EQ 32 A8MP MD20**

Miscelatore doccia termostatico con attacco superiore da 3/4" ed attacco inferiore da 1/2" con deviatore integrato, colonna doccia telescopica, doccetta anticalcare a 4 funzioni, con pulsante per il cambio dei getti e flessibile 333 CNX 150 cm e soffione lusso a pioggia, in ABS cromato, Ø 20 cm, con getti in silicone anticalcare.



**EQ 32X UFM20**

Miscelatore doccia termostatico con deviatore integrato, attacco superiore da 3/4", attacco inferiore da 1/2", colonna doccia minimale, doccetta anticalcare a 4 funzioni, con flessibile 333 CNX 150 cm e soffione a pioggia, in acciaio INOX lucidato a specchio, Ø 20 cm, con getti in silicone anticalcare.



**EQ 32 XUFM25**

Miscelatore doccia termostatico con deviatore integrato, attacco superiore da 3/4", attacco inferiore da 1/2", colonna doccia minimale, doccetta anticalcare a 4 funzioni, con flessibile 333 CNX 150 cm e soffione lusso a pioggia, in acciaio INOX lucidato a specchio, Ø 25 cm, con getti in silicone anticalcare.



**EQ 32 X8CP UFD20**

Miscelatore doccia termostatico con deviatore integrato, attacco superiore da 3/4", attacco inferiore da 1/2", colonna doccia minimale, doccetta anticalcare a 4 funzioni, con pulsante per il cambio dei getti e flessibile 333 CNX 150 cm e soffione a pioggia squadrato con angoli arrotondati, in acciaio INOX lucidato a specchio, 20x20 cm, con getti in silicone anticalcare.



### EQ 32 X8CP UFD25

Miscelatore doccia termostatico con deviatore integrato, attacco superiore da 3/4", attacco inferiore da 1/2", colonna doccia minimale, doccetta anticalcare a 4 funzioni, con pulsante per il cambio dei getti e flessibile 333 CNX 150 cm e soffione ultrapiatto a pioggia squadrato con angoli arrotondati, in acciaio INOX lucidato a specchio, 25x25 cm, con getti in silicone anticalcare.



### EQ 32 XEC20

Miscelatore doccia termostatico con deviatore integrato, attacco superiore da 3/4", attacco inferiore da 1/2", colonna doccia minimale, doccetta anticalcare a 4 funzioni, con flessibile 333 CNX 150 cm e soffione Ø 20 cm, in ABS cromato.



### EQ 32 XMD20

Miscelatore doccia termostatico con deviatore integrato, attacco superiore da 3/4", attacco inferiore da 1/2", colonna doccia minimale, doccetta anticalcare a 4 funzioni, con flessibile 333 CNX 150 cm e soffione Ø 20 cm, in ABS cromato.



### EQ 32 X8CP AD20

Miscelatore doccia termostatico con deviatore integrato, attacco superiore da 3/4", attacco inferiore da 1/2", colonna doccia minimale, doccetta anticalcare a 4 funzioni, con pulsante per il cambio dei getti e flessibile 333 CNX 150 cm e soffione quadrato con angoli arrotondati 20x20 cm, in ABS cromato.



### EQ 32 X8MP MD20

Miscelatore doccia termostatico con deviatore integrato, attacco superiore da 3/4", attacco inferiore da 1/2", colonna doccia minimale, doccetta anticalcare a 4 funzioni, con pulsante per il cambio dei getti e flessibile 333 CNX 150 cm e soffione Ø 20 cm, in ABS cromato.



### EQ 32 U

Miscelatore doccia termostatico con deviatore integrato, attacco superiore da 3/4", attacco inferiore da 3/4", colonna doccia minimale, doccetta minimale tonda, con flessibile 150 cm e soffione Ø 20 cm, in ABS cromato.

# Q-ELEGANCE

## CARATTERISTICHE TECNICHE:

La serie è dotata di cartuccia termostatica prodotta da S.T.S.R. – Studio Tecnico Sviluppo e Ricerche [www.stsr.it](http://www.stsr.it).  
Finiture disponibili: cromo



ELEGANCE

Q-ELEGANCE

MINIMAL THERMO

QUBIKA THERMO

THERMO





L'utilizzo dei modelli termostatici può aiutare ad avere un maggiore controllo sul consumo di acqua e energia, risparmiando la quantità di acqua solitamente sprecata cercando la temperatura desiderata.

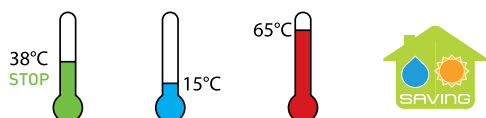

#### CARATTERISTICHE TECNICHE:

- Blocco di sicurezza: 38°C
- Campo di lavoro: da 15°C a 65°C
- Differenziale termico consigliato 50°C
- Campo di pressione in rete: da 1 a 5 bar dinamici
- Sistema di sicurezza con blocco dell'erogazione in caso di mancanza di una delle due acque
- Filtro in acciaio INOX per il trattamento delle impurità

#### SIMBOLOGIE:



Termostatico.



Con Kit Doccia e flessibile lungo: 120, 150 o 200 cm



Doccetta Anticalcare



Soffione Autopulente



Getto ad ampia copertura effetto pioggia



Getto spray delicato ad ampia copertura con getto vigoroso all'esterno a risparmio idrico



Ampia getto pioggia a risparmio idrico



Prodotto novità



## GRUPPI VASCA E DOCCIA TERMOSTATICI



#### ST 31

Miscelatore esterno doccia termostatico, forma quadrata, con attacco inferiore da 1/2", maniglie in abs cromato.



#### ST 31L

Miscelatore esterno doccia termostatico, forma quadrata, con attacco inferiore da 1/2", maniglie in ottone cromato.

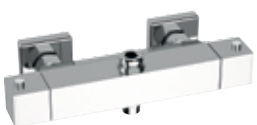

#### ST 32

Miscelatore esterno doccia termostatico, forma quadrata, con deviatore incorporato ed attacco alto da 3/4' ed attacco inferiore da 1/2", maniglie in abs cromato.



#### ST 32L

Miscelatore esterno doccia termostatico, forma quadrata, con deviatore incorporato ed attacco alto da 3/4' ed attacco inferiore da 1/2", maniglie in ottone cromato.

## COLONNE DOCCIA TERMOSTATICHE



### ST 32L S7SQ UFS20

Colonna doccia quadrata con miscelatore doccia termostatico con deviatore integrato, attacco superiore da 3/4", colonna doccia in ottone cromato e doccetta Qubika ad 1 funzione con getti in silicone, anticalcare, flessibile 333CN 150 cm e soffione ultra piatto 20x20 cm in acciaio INOX lucidato a specchio, con getti effetto pioggia in silicone, anticalcare.



### ST 31 317Q 317DS

Kit doccia composto da miscelatore esterno doccia termostatico ST31, saliscendi lusso ultrapiatto in ottone cromato 317Q, doccetta in abs cromata 317DS e flessibile 333CN 150 cm.



### ST 32S 7DS 56S

Colonna doccia quadrata con miscelatore doccia termostatico con deviatore integrato, attacco superiore da 3/4", colonna doccia in ottone cromato e doccetta minimale in ABS ad 1 funzione, con flessibile 333CN 150 cm e soffione a snodo in ABS, cromato art. 356S 23x23 cm, con getti effetto pioggia in silicone, anticalcare.



### ST 31L 317Q 317SQ

Kit doccia composto da miscelatore esterno doccia termostatico quadrato tipo lusso, con maniglie in ottone cromato ST31L, saliscendi lusso ultrapiatto in ottone cromato 317Q, doccetta anticalcare con getti in silicone 317SQ e flessibile 333CN 150 cm.

ELEGANCE

Q-ELEGANCE

MINIMAL THERMO

QUBIKA THERMO

THERMO



# MINIMAL THERMO

## CARATTERISTICHE TECNICHE:

La serie è dotata di cartuccia termostatica prodotta da S.T.S.R. – Studio Tecnico Sviluppo e Ricerche [www.stsr.it](http://www.stsr.it).  
Finiture disponibili: cromo, bianco opaco, nero opaco.

# TERMOSTATICI

ELEGANCE

Q-ELEGANCE

MINIMAL THERMO

QUBIKA THERMO

THERMO







L'utilizzo dei modelli termostatici può aiutare ad avere un maggiore controllo sul consumo di acqua e energia, risparmiando la quantità di acqua solitamente sprecata cercando la temperatura desiderata.

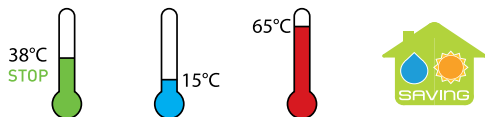

#### CARATTERISTICHE TECNICHE:

- Blocco di sicurezza: 38°C
- Campo di lavoro: da 15°C a 65°C
- Differenziale termico consigliato 50°C
- Campo di pressione in rete: da 1 a 5 bar dinamici
- Sistema di sicurezza con blocco dell'erogazione in caso di mancanza di una delle due acque
- Filtro in acciaio INOX per il trattamento delle impurità

#### SIMBOLOGIE:

**TH**  
Termostatico

**THC**  
Termostatico corpo freddo

Con Kit Doccia e flessibile lungo: 120, 150 o 200 cm

Doccetta Anticalcare

Soffione Anticalcare ed Autopulente

Getti Anticalcare

Risparmio energetico

Colonna doccia girevole

Colonna doccia girevole e telescopica



Getto con massaggio intenso a risparmio idrico



Getto Esterno



Getto spray delicato ad ampia copertura con getto vigoroso all'esterno a risparmio idrico



Getto ad ampia copertura effetto pioggia



Con getto a cascata



Prodotto novità

CR = cromato

BO = bianco opaco

NO = nero opaco

## GRUPPI DOCCIA TERMOSTATICI



### NT 60 W

Miscelatore incasso per shut-off comprensivo di: doccetta shut-off art 332 OW, supporto doccia-presa acqua su piastra in ottone cromato e flessibile doccia cm 120.



### NT 39

Miscelatore monocomando termostatico esterno per doccia, con doccia duplex in ottone cromato.



## TERMOSTATICI



### NT 35

Miscelatore esterno doccia termostatico con attacco alto da 3/4".



### NT 31

Miscelatore esterno doccia termostatico con attacco inferiore da 1/2".



### NT 35 V

Miscelatore esterno doccia termostatico verticale, con attacco alto da 3/4".

## GRUPPI DOCCIA TERMOSTATICI A CORPO FREDDO



### NT 31F

Miscelatore esterno doccia termostatico a corpo freddo con attacco inferiore da 1/2".



### NT 35F

Miscelatore esterno doccia termostatico a corpo freddo con attacco alto da 3/4".



### NT 32F

Miscelatore esterno doccia termostatico a corpo freddo con attacco alto da 3/4" ed attacco inferiore da 1/2".

## INCASSI TERMOSTATICI



### NT 09

Miscelatore termostatico da incasso con deviatore per vasca-doccia.

### NT 09 B

Parte interna miscelatore monocomando incasso vasca/doccia con deviatore.

### NT 09 E

Parte esterna miscelatore termostatico monocomando incasso vasca/doccia con deviatore.



### NT 30

Miscelatore termostatico da incasso per doccia, senza deviatore.

### NT 30 B

Parte interna miscelatore monocomando incasso doccia.

### NT 30 E

Parte esterna miscelatore termostatico monocomando incasso doccia.



### NT 92

Miscelatore termostatico per doccia, con deviatore a due posizioni (due uscite ed una entrata) su piastra unica.



### NT 93

Miscelatore termostatico per doccia con deviatore a tre vie (una entrata e tre uscite) su unica piastra

### NT 93 7

Miscelatore termostatico per doccia con deviatore a tre vie e sette posizioni (una entrata, tre uscite e sette posizioni con cui selezionare uscite singole o miscelate tra loro) su unica piastra.



### NT 94

Miscelatore termostatico per doccia, con deviatore a 4 posizioni (4 uscite ed 1 entrata) su piastra unica.

### NT 95

Miscelatore termostatico per doccia, con deviatore a 5 posizioni (5 uscite ed una entrata) su piastra unica.



### NT 94 C

Miscelatore termostatico per doccia, con deviatore a 4 posizioni (4 uscite ed 1 entrata) su doppia piastra, con possibilità di chiusura del flusso dal deviatore durante il cambio di posizione

### NT 95 C

Miscelatore termostatico per doccia, con deviatore a 5 posizioni (5 uscite ed una entrata) su doppia piastra, con possibilità di chiusura del flusso dal deviatore durante il cambio di posizione

ELEGANCE

Q-ELEGANCE

MINIMAL THERMO

QUBIKA THERMO

THERMO



**NT 92 Q**

Miscelatore termostatico per doccia, con deviatore a due posizioni (due uscite ed una entrata) su piastra unica rettangolare.



**NT 93 Q**

Miscelatore termostatico per doccia con deviatore a tre vie (una entrata e tre uscite) su unica piastra rettangolare.



**NT 94 Q**

Miscelatore termostatico per doccia, con deviatore a 4 posizioni (4 uscite ed 1 entrata) su piastra unica rettangolare.

**NT 93 7 Q**

Miscelatore termostatico per doccia con deviatore a tre vie e sette posizioni (una entrata, tre uscite e sette posizioni con cui selezionare uscite singole o miscelate tra loro) su piastra unica rettangolare.

**NT 95 Q**

Miscelatore termostatico per doccia, con deviatore a 5 posizioni (5 uscite ed una entrata) su piastra unica rettangolare.

**BOX INCASSO**



**RR BOX**

Box da incasso per miscelatore doccia con deviatore.



**NT 30 KB**

Set miscelatore doccia termostatico da abbinare al box incasso.



**RR BOX**

Box da incasso per miscelatore doccia con deviatore.

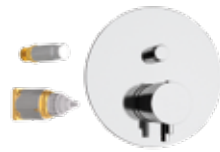

**NT 09 KB**

Set miscelatore doccia termostatico con deviatore da abbinare al box incasso.



**RR BOX 93**

Box da incasso per miscelatore doccia tre vie.



**NT 93 KB**

Set miscelatore doccia tre vie da abbinare al box incasso.



**RR BOX 92**

Box da incasso per miscelatore doccia due vie.



**NT 92 KB**

Set miscelatore doccia due vie da abbinare al box incasso.



**RR BOX 93**

Box da incasso per miscelatore doccia tre vie.



**NT 93 7 KB**

Set miscelatore doccia tre vie e sette uscite da abbinare al box incasso.



ELEGANCE

Q-ELEGANCE

MINIMAL THERMO

QUBIKA THERMO

## COLONNE DOCCIA TERMOSTATICHE

THERMO

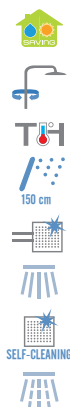

### NT 37 B

Set doccia composto da: Miscelatore termostatico esterno doccia NT35 con colonna doccia minimale con saliscendi e deviatore, doccetta anticalcare in abs cromato 317DM e soffione in abs cromato e anticalcare 356MD20 Ø 20 cm. Flessibile in ottone cromato incluso.



### NT 37

Set doccia composto da: Miscelatore termostatico esterno doccia NT35 con colonna doccia deluxe con saliscendi e deviatore, doccetta anticalcare in ottone cromato 317MM e soffione in ottone cromato e anticalcare 359MM20 Ø 20 cm. Flessibile in ottone cromato incluso.



### NT 37 XL

Set doccia composto da: Miscelatore termostatico esterno doccia NT35 con colonna doccia deluxe con saliscendi e deviatore, doccetta anticalcare in ottone cromato 317MM e soffione ultrapiatto in ottone cromato e anticalcare 359MMXL Ø 35 cm. Flessibile in ottone cromato incluso.



**NT 37 B XL**

Set doccia composto da:  
Miscelatore termostatico esterno doccia NT35 con colonna doccia minimale con saliscendi e deviatore, doccetta anticalcare in abs cromato 317DM e soffione in abs cromato e anticalcare 356MD25 Ø 25 cm. Flessibile in ottone cromato incluso.



**NT 36**

Set doccia composto da:  
Miscelatore termostatico verticale esterno doccia NT35V con colonna doccia deluxe con saliscendi e deviatore, doccetta anticalcare in ottone cromato 317MM e soffione in ottone cromato e anticalcare 359MM20 Ø 20 cm. Flessibile in ottone cromato incluso.



**NT 36 XL**

Set doccia composto da:  
Miscelatore termostatico verticale esterno doccia NT35V con colonna doccia deluxe con saliscendi e deviatore, doccetta anticalcare in ottone cromato 317MM e soffione ultrapiatto in ottone cromato e anticalcare 359MMXL Ø 35 cm. Flessibile in ottone cromato incluso.

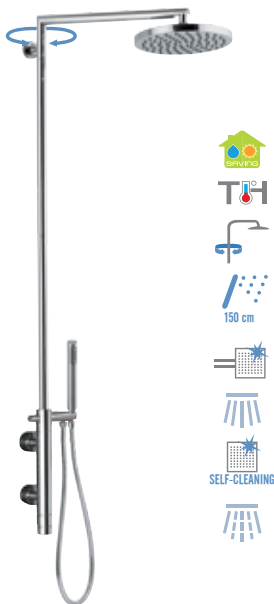

**NT 36 B**

Set doccia composto da:  
Miscelatore termostatico esterno doccia NT35V con colonna doccia minimale con saliscendi e deviatore, doccetta anticalcare in abs cromato 317DM e soffione in abs cromato e anticalcare 356MD20 Ø 20 cm. Flessibile in ottone cromato incluso.



**NT 36 B XL**

Set doccia composto da:  
Miscelatore termostatico esterno doccia NT35V con colonna doccia minimale con saliscendi e deviatore, doccetta anticalcare in abs cromato 317DM e soffione in abs cromato e anticalcare 356MD25 Ø 25 cm. Flessibile in ottone cromato incluso.

## COLONNA DOCCIA TERMOSTATICA A CORPO FREDDO



### NT 37F XL

Set doccia composto da: Miscelatore termostatico a corpo freddo esterno doccia NT32F con colonna doccia deluxe con saliscendi e deviatore, doccetta anticalcare in ottone cromato 317MM e soffione ultrapiatto in ottone cromato e anticalcare 359MMXL Ø 35 cm. Flessibile in ottone cromato incluso.

### LA SICUREZZA AL TATTO

Assicura che la superficie esterna del termostatico non sia mai troppo calda al tatto, evitando scottature.

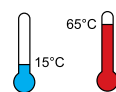
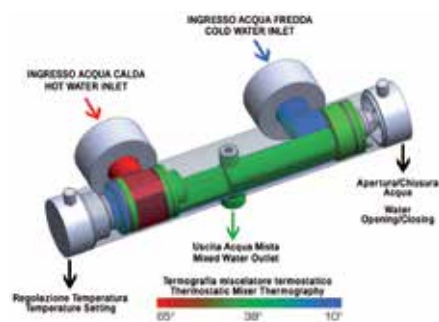

100% Sicuro ed efficace  
Questa tecnologia consente di proteggere l'utente separando il flusso dell'acqua calda all'interno del miscelatore dalla superficie esterna, evitando che il corpo umano venga a contatto diretto.

ELEGANCE

Q-ELEGANCE

MINIMAL THERMO

QUBIKA THERMO

THERMO





WELLNESS



**NT 93 7 S01 UFMCA**

Set doccia composto da:  
 Art. 350UFMCA: soffione doccia a parete 50x20cm, in acciaio INOX lucidato a specchio, 2 getti, pioggia e cascata.  
 Art. 317M 317MM con 333CN 150: Saliscendi minimale con doccetta anticalcare e flessibile conico in ottone cromato.  
 Art. 309 L: presa acqua tipo rotondo pesante.  
 Art. NT 93 7: miscelatore monocomando incasso termostatico per doccia con deviatore a tre vie e sette posizioni su unica piastra.



**NT 09 S01 UFM**

Set doccia composto da:  
 Art. 350UFM: soffione doccia a parete 50x20cm, in acciaio INOX lucidato a specchio, getto pioggia.  
 Art. 337M 317MM con 333CN 150: Doccia duplex minimale anticalcare con supporto presa acqua e flessibile conico in ottone cromato cm 150.  
 Art. 309 L: presa acqua tipo rotondo pesante.  
 Art. NT 09: Miscelatore incasso termostatico con deviatore e piastra lusso.



**NT 93 7 S02 UFMCA**

Set doccia composto da:  
 Art. 350UFMCA: soffione doccia a parete 50x20cm, in acciaio INOX lucidato a specchio, 2 getti, pioggia e cascata.  
 Art. 337M 317MM con 333CN 150: Doccia duplex minimale anticalcare con supporto presa acqua e flessibile conico in ottone cromato cm 150.  
 Art. NT 93 7: miscelatore monocomando incasso termostatico per doccia con deviatore a tre vie e sette posizioni su unica piastra.



**NT 09 S02 UFM**

Set doccia composto da:  
 Art. 350UFM: soffione doccia a parete 50x20cm, in acciaio INOX lucidato a specchio, getto pioggia.  
 Art. 337M 317MM con 333CN 150: Doccia duplex minimale anticalcare con supporto presa acqua e flessibile conico in ottone cromato cm 150.  
 Art. NT 09: Miscelatore incasso termostatico con deviatore e piastra lusso.



**NT 93 7 S03 UFMCA**

Set doccia composto da:  
 Art. 350UFMCA: soffione doccia a parete 50x20cm, in acciaio INOX lucidato a specchio, 2 getti, pioggia e cascata.  
 Art. 339N 317MM con 333CN 150: Doccia duplex minimale anticalcare con supporto duplex e flessibile conico in ottone cromato cm 150.  
 Art. 91 MD: Bocca incasso con deviatore integrato.  
 Art. NT 93 7: miscelatore monocomando incasso termostatico per doccia con deviatore a tre vie e sette posizioni su unica piastra.



**NT 09 S03 UFM**

Set doccia composto da:  
 Art. 350UFM: soffione doccia a parete 50x20cm, in acciaio INOX lucidato a specchio, getto pioggia.  
 Art. 339N 317MM con 333CN 150: Doccia duplex minimale anticalcare con supporto duplex e flessibile conico in ottone cromato cm 150.  
 Art. 91 MD: Bocca incasso con deviatore integrato.  
 Art. NT 09: Miscelatore incasso termostatico con deviatore e piastra lusso.



**NT 09 S11**

Set doccia composto da:  
 Art. 330U 356LU 317DM 330RA con 333CN 150: Colonna doccia deluxe girevole con deviatore e saliscendi, completa di soffione doccia cromato anticalcare, doccetta minimale, flessibile doccia e supporto presa acqua per colonna.  
 Art. NT 09: Miscelatore monocomando incasso termostatico con deviatore e piastra lusso.  
 Art. 91M: Bocca incasso Minimale.







## NT 09 S02

Set doccia composto da:  
 Art. 356LU 348N 30: Soffione minimale anticalcare con braccio in ottone Ø 30 cm.  
 Art. 337M 317DM con 333CN 150: Doccia duplex minimale anticalcare con supporto presa acqua e flessibile conico in ottone cromato cm 150.  
 Art. NT 09: Miscelatore incasso termostatico con deviatore e piastra lusso.

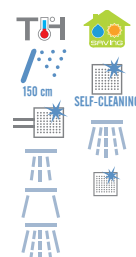

## NT 93 7 S01

Set doccia composto da:  
 Art. 359MM30 348N 30: soffione minimale anticalcare in ottone Ø 30 cm, con braccio in ottone cm 30.  
 Art. 337M 321HG con 333CN 150: Doccia minimale a 2 funzioni, con getti in silicone, supporto doccia duplex in ottone cromato con presa acqua e flessibile conico in ottone cromato cm 150.  
 Art. N 34 JET: 6 getti minimali anticalcare in ottone cromato.  
 Art. NT 93 7: miscelatore monocomando incasso termostatico per doccia con deviatore a tre vie e sette posizioni su unica piastra.



## NT 09 S01

Set doccia composto da:  
 Art. 356LU 348N 30: Soffione minimale anticalcare con braccio in ottone Ø 30 cm.  
 Art. 317M 317DM con 333CN 150: Saliscendi minimale con doccetta anticalcare e flessibile conico in ottone cromato.  
 Art. 309 L: presa acqua tipo rotondo pesante.  
 Art. NT 09: Miscelatore incasso termostatico con deviatore e piastra lusso.

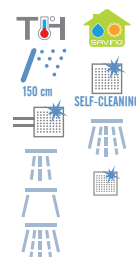

## NT 93 7 S02

Set doccia composto da:  
 Art. 359MM30 348N 30: soffione minimale anticalcare in ottone Ø 30 cm, con braccio in ottone cm 30.  
 Art. 317G 321HG con 333CN 150: Saliscendi in ottone cromato e doccetta minimale a 2 funzioni con getti in silicone e flessibile conico in ottone cromato cm 150.  
 Art. N 34 JET: 6 getti minimali anticalcare.  
 Art. NT 93 7: miscelatore monocomando incasso termostatico per doccia con deviatore a tre vie e sette posizioni su unica piastra.



## NT 09 S03

Set doccia composto da:  
 Art. 356LU 348N 30: Soffione minimale anticalcare con braccio in ottone Ø 30 cm.  
 Art. 339N 317DM con 333CN 150: Doccia duplex minimale anticalcare con supporto duplex e flessibile conico in ottone cromato cm 150.  
 Art. 91 MD: Bocca incasso Minimal con deviatore integrato.  
 Art. NT 09: Miscelatore incasso termostatico con deviatore e piastra lusso.

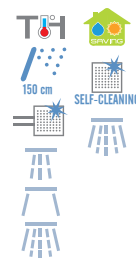

## NT 93 7 S03

Set doccia composto da:  
 Art. 359MM30 348N 30: soffione minimale anticalcare in ottone Ø 30 cm, con braccio in ottone cm 30.  
 Art. 337M 321HG con 333CN 150: Doccia minimale a 2 funzioni, con getti in silicone, supporto doccia duplex in ottone cromato con presa acqua e flessibile conico in ottone cromato cm 150.  
 Art. 91 M: bocca incasso minimale.  
 Art. NT 93 7: miscelatore monocomando incasso termostatico per doccia con deviatore a tre vie e sette posizioni su unica piastra.

ELEGANCE

Q-ELEGANCE

MINIMAL THERMO

QUBIKA THERMO

THERMO

# QUBIKA THERMO

## CARATTERISTICHE TECNICHE:

La serie è dotata di cartuccia termostatica prodotta da S.T.S.R. – Studio Tecnico Sviluppo e Ricerche - [www.stsr.it](http://www.stsr.it).  
Finiture disponibili: cromo, bianco opaco, nero opaco.

TERMOSTATICI

ELEGANCE

Q-ELEGANCE

MINIMAL THERMO

QUBIKA THERMO

THERMO





L'utilizzo dei modelli termostatici può aiutare ad avere un maggiore controllo sul consumo di acqua e energia, risparmiando la quantità di acqua solitamente sprecata cercando la temperatura desiderata.

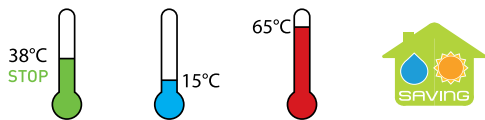

#### CARATTERISTICHE TECNICHE:

- Blocco di sicurezza: 38°C
- Campo di lavoro: da 15°C a 65°C
- Differenziale termico consigliato 50°C
- Campo di pressione in rete: da 1 a 5 bar dinamici
- Sistema di sicurezza con blocco dell'erogazione in caso di mancanza di una delle due acque
- Filtro in acciaio INOX per il trattamento delle impurità

#### SIMBOLOGIE:

 Termostatico.	 Termostatico corpo freddo.	 Con Kit Doccia e flessibile lungo: 120, 150 o 200 cm	 Doccetta Anticalcare	 Soffione Anticalcare ed Autopulente	 Getti Anticalcare	 Ampio getto pioggia a risparmio idrico	 Getto ad ampia copertura effetto pioggia	 Con getto a cascata.	
CR = cromato			BO = bianco opaco			NO = nero opaco			

### GRUPPI DOCCIA TERMOSTATICI

			
<b>QT 31</b> Miscelatore termostatico esterno doccia, con attacco inferiore da 1/2".	<b>QT 35</b> Miscelatore termostatico esterno doccia, con attacco superiore da 3/4".	<b>QT 35 V</b> Miscelatore termostatico esterno doccia verticale, con attacco superiore da 3/4".	<b>QT 39</b> Miscelatore termostatico esterno per doccia, con doccia duplex.
			

### GRUPPI DOCCIA A TERMOSTATICI CORPO FREDDO

		
<b>QT 35 F</b> Miscelatore termostatico esterno doccia corpo freddo, con attacco superiore da 3/4".	<b>QT 31 F</b> Miscelatore termostatico esterno doccia corpo freddo, con attacco inferiore da 1/2".	<b>QT 32 F</b> Miscelatore termostatico esterno doccia corpo freddo, con attacco alto da 3/4" ed attacco inferiore da 1/2".
		



# TERMOSTATICI

## COLONNE DOCCIA TERMOSTATICHE A CORPO FREDDO



### QT 37F XL

Set doccia composto da:  
 Miscelatore termostatico esterno doccia a corpo freddo QT32F con colonna doccia quadra con saliscendi e deviatore, doccetta anticalcare 317SQ e soffione completamente in ottone cromato e anticalcare 359SSXL 35x35 cm.  
 Flessibile in ottone cromato incluso.

### LA SICUREZZA AL TATTO

Assicura che la superficie esterna del termostatico non sia mai troppo calda al tatto, evitando scottature.

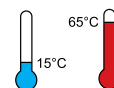
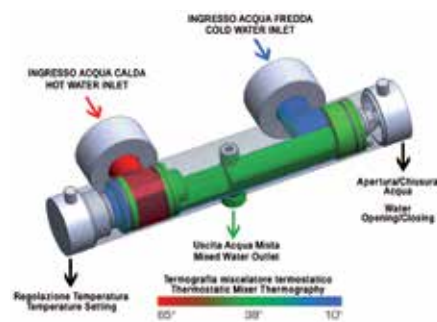

100% Sicuro ed efficace  
 Questa tecnologia consente di proteggere l'utente separando il flusso dell'acqua calda all'interno del miscelatore dalla superficie esterna, evitando che il corpo umano venga a contatto diretto.

ELEGANCE

Q-ELEGANCE

MINIMAL THERMO

QUBIKA THERMO

THERMO



## COLONNE DOCCIA TERMOSTATICHE



### QT 36

Set doccia composto da: Miscelatore termostatico esterno doccia QT35V con deviatore, flessibile e doccetta 317RR, con colonna doccia quadra con soffione completamente in ottone cromato e anticalcare 359SS 20x2 cm.



### QT 36 XL

Set doccia composto da: Miscelatore termostatico esterno doccia QT35V con deviatore, flessibile e doccetta in ottone 317RR, con colonna doccia quadra con soffione completamente in ottone cromato e anticalcare 359SSXL 35x35 cm.

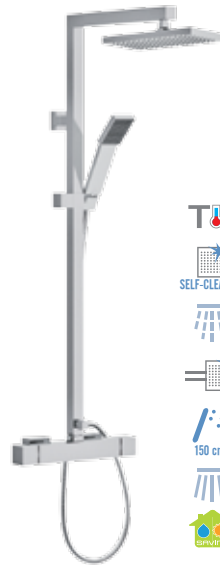

### QT 37

Set doccia composto da: Miscelatore termostatico esterno doccia QT35 con colonna doccia quadra con saliscendi e deviatore, doccetta anticalcare 317SQ e soffione completamente in ottone cromato e anticalcare 359SS 20x20 cm. Flessibile in ottone cromato incluso.



### QT 37 XL

Set doccia composto da: Miscelatore termostatico esterno doccia QT35 con colonna doccia quadra con saliscendi e deviatore, doccetta anticalcare 317SQ e soffione completamente in ottone cromato e anticalcare 359SSXL 35x35 cm. Flessibile in ottone cromato incluso.

## INCASSI TERMOSTATICI



### QT 09

Miscelatore termostatico da incasso con deviatore per vasca/doccia.

### NT 09 B

Parte interna miscelatore termostatico da incasso con deviatore per vasca/doccia.

### QT 09 E

Parte esterna miscelatore termostatico da incasso con deviatore per vasca/doccia.



### QT 30

Miscelatore termostatico da incasso per doccia, senza deviatore.

### NT 30 B

Parte interna miscelatore termostatico da incasso per doccia, senza deviatore.

### QT 30 E

Parte esterna miscelatore termostatico da incasso per doccia, senza deviatore.



### QT 92

Miscelatore termostatico per doccia, con deviatore a due posizioni (due uscite ed una entrata) su piastra unica.





**QT 93**  
Miscelatore termostatico per doccia con deviatore a tre vie (una entrata e tre uscite) su piastra unica.

**QT 93 7**  
Miscelatore termostatico per doccia con deviatore a tre vie e sette posizioni (una entrata, tre uscite e sette posizioni con cui selezionare uscite singole o miscelate tra loro) su piastra unica.



**QT 95**  
Miscelatore termostatico per doccia, con deviatore a 5 posizioni (5 uscite ed una entrata) su piastra unica.

**QT 94**  
Miscelatore termostatico per doccia, con deviatore a 4 posizioni (4 uscite ed 1 entrata) su piastra unica.



**QT 94 C**  
Miscelatore termostatico per doccia, con deviatore a 4 posizioni (4 uscite ed 1 entrata) su doppia piastra, con possibilità di chiusura del flusso dal deviatore durante il cambio di posizione.

**QT 95 C**  
Miscelatore termostatico per doccia, con deviatore a 5 posizioni (5 uscite ed una entrata) su doppia piastra, con possibilità di chiusura del flusso dal deviatore durante il cambio di posizione.

ELEGANCE

Q-ELEGANCE

MINIMAL THERMO

QUBIKA THERMO

THERMO

## BOX INCASSO



**RR BOX**  
Box da incasso per miscelatore doccia con deviatore.

**QT 30 KB**  
Set miscelatore doccia termostatico da abbinare al box incasso.

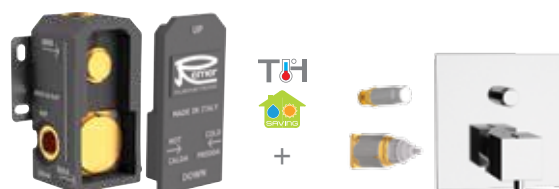

**RR BOX**  
Box da incasso per miscelatore doccia con deviatore.

**QT 09 KB**  
Set miscelatore doccia termostatico con deviatore da abbinare al box incasso.



**RR BOX 93**  
Box da incasso per miscelatore doccia tre vie.

**QT 93 KB**  
Set miscelatore doccia tre vie da abbinare al box incasso.



**RR BOX 92**  
Box da incasso per miscelatore doccia due vie.

**QT 92 KB**  
Set miscelatore doccia due vie da abbinare al box incasso.



**RR BOX 93**  
Box da incasso per miscelatore doccia tre vie.

**QT 93 7 KB**  
Set miscelatore doccia tre vie e sette uscite da abbinare al box incasso.



## WELLNESS



### QT 09 S01

Set doccia composto da:  
 Art. 359SS 348S 30: Soffione SQ in ottone anticalcare con braccio quadro in ottone cm 30.  
 Art. 317S 317SQ: Saliscendi quadro con doccetta Q anticalcare e flessibile conico in ottone cromato cm 150.  
 Art. 309 S: Presa acqua lusso quadrata.  
 Art. QT 09: Miscelatore incasso termostatico con deviatore.



### QT 93 7 S01 SSCA

Set doccia composto da:  
 Art. 350SSCA soffione doccia a parete 50x20cm, in acciaio INOX lucidato aspecchio, 2 getti, pioggia e cascata.  
 Art. 317S 317SQ: Saliscendi quadro con doccetta Q anticalcare e flessibile conico in ottone cromato cm 150.  
 Art. 309 S: Presa acqua lusso quadrata.  
 Art. QT 93 7 miscelatore termostatico monocomando per doccia con deviatore a tre vie e 7 posizioni su piastra unica.



### QT 09 S01 SS

Set doccia composto da:  
 Art. 350SS soffione doccia a parete 50x20cm, in acciaio INOX lucidato a specchio.  
 Art. 317S 317SQ: Saliscendi quadro con doccetta Q anticalcare e flessibile conico in ottone cromato cm 150.  
 Art. 309 S: Presa acqua lusso quadrata.  
 Art. QT 09: Miscelatore incasso termostatico con deviatore.



### QT 09 S02

Set doccia composto da:  
 Art. 359SS 348S30: Soffione SQ in ottone anticalcare con braccio quadro in ottone cm 30.  
 Art. 337S: Supporto doccia deluxe duplex con presa acqua.  
 Art. 317SQ con 333CN150 con doccetta Q anticalcare e flessibile conico in ottone cromato cm 150.  
 Art. QT 09: Miscelatore incasso termostatico con deviatore.



### QT 93 7 S02 SSCA

Set doccia composto da:  
 Art. 350SSCA soffione doccia a parete 50x20cm, in acciaio INOX lucidato aspecchio, 2 getti, pioggia e cascata.  
 Art. 337S: Supporto doccia deluxe duplex con presa acqua.  
 Art. 317SQ con 333CN150 con doccetta Q anticalcare e flessibile conico in ottone cromato cm 150.  
 Art. QT 93 7 miscelatore termostatico monocomando per doccia con deviatore a tre vie e 7 posizioni su piastra unica



### QT 09 S02 SS

Set doccia composto da:  
 Art. 350SS soffione doccia a parete 50x20cm, in acciaio INOX lucidato a specchio.  
 Art. 337S: Supporto doccia deluxe duplex con presa acqua.  
 Art. 317SQ con 333CN150 con doccetta Q anticalcare e flessibile conico in ottone cromato cm 150.  
 Art. QT 09: Miscelatore incasso termostatico con deviatore.



### QT 09 S03 CR € 654,70 BO-NO € 1.047,60

Set doccia composto da:  
 Art. 359SS 348S30: Soffione SQ in ottone anticalcare con braccio quadro in ottone cm 30.  
 Art. 339S 317SQ con 333CN 150: Supporto doccia cromato con doccetta Q anticalcare e flessibile conico in ottone cromato cm 150.  
 Art. 91 QD: Bocca incasso Q con deviatore.  
 Art. QT 09: Miscelatore incasso termostatico con deviatore.



### QT 93 7 S03 SSCA

Set doccia composto da:  
 Art. 350SSCA soffione doccia a parete 50x20cm, in acciaio INOX lucidato aspecchio, 2 getti, pioggia e cascata.  
 Art. 337S 317SQ con 333CN 150: Supporto doccia cromato con doccetta Q anticalcare e flessibile conico in ottone cromato cm 150.  
 Art. 91 Q: Bocca incasso Q.  
 Art. QT 93 7 miscelatore termostatico monocomando per doccia con deviatore a tre vie e 7 posizioni su piastra unica.



### QT 09 S03 SS

Set doccia composto da:  
 Art. 350SS soffione doccia a parete 50x20cm, in acciaio INOX lucidato a specchio.  
 Art. 339S 317SQ con 333CN 150: Supporto doccia cromato con doccetta Q anticalcare e flessibile conico in ottone cromato cm 150.  
 Art. 91 QD: Bocca incasso Q con deviatore.  
 Art. QT 09: Miscelatore incasso termostatico con deviatore.



## QT 93 7 S01

Set doccia composto da:

Art. 359SS 348S30: Soffione SQ in ottone anticalcare con braccio quadro in ottone cm 30.

Art. 317S 317SQ: saliscendi Q in ottone cromato con doccetta Q anticalcare e flessibile conico in ottone cromato cm 150.

Art. 309S: Presa acqua Q in ottone cromato.

Art. Q 34 JET: 6 getti anticalcare Q in ottone cromato.

Art. QT 93 7: Miscelatore incasso termostatico con deviatore a tre vie e sette posizioni su piastra unica.

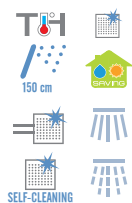

## QT 93 7 S02

Set doccia composto da:

Art. 359SS 348S30: Soffione SQ in ottone anticalcare con braccio quadro in ottone cm 30.

Art. 337 S: Supporto doccia deluxe duplex con presa acqua.

Art. 317SQ con 333CN 150: con doccetta Q anticalcare e flessibile conico in ottone cromato cm 150.

Art. Q 34 JET: 6 getti anticalcare Q in ottone cromato.

Art. QT 93 7: Miscelatore incasso termostatico con deviatore a tre vie e sette posizioni su piastra unica.

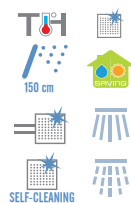

## QT 93 7 S03

Set doccia composto da:

Art. 359SS 348S30: Soffione SQ in ottone anticalcare con braccio quadro in ottone cm 30.

Art. 337 S: Supporto doccia deluxe duplex con presa acqua.

Art. 317SQ con 333CN 150: con doccetta Q anticalcare e flessibile conico in ottone cromato cm 150.

Art. 91 Q: Bocca incasso serie Q.

Art. QT 93 7: Miscelatore incasso termostatico con deviatore a tre vie e sette posizioni su piastra unica.

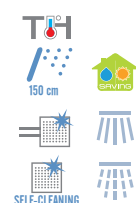

## QT 30 S11

Set doccia composto da:

Art. 330S 359 SS 317SQ 333CN 150: Colonna doccia a barra quadrata, deluxe, con deviatore e saliscendi, soffione doccia quadrato in ottone con getti in silicone anticalcare, doccetta serie Qubika anticalcare, flessibile doccia conico in ottone.

Art. 330SRA: Presa acqua/attacco a muro quadrato.

Art. QT 30: Miscelatore incasso termostatico doccia Qubika.



ELEGANCE

Q-ELEGANCE

MINIMAL THERMO

QUBIKA THERMO

THERMO

# THERMO

## CARATTERISTICHE TECNICHE:

La serie è dotata di cartuccia termostatica prodotta da  
S.T.S.R. – Studio Tecnico Sviluppo e Ricerche - [www.stsr.it](http://www.stsr.it)

# TERMOSTATICI

ELEGANCE

Q-ELEGANCE

MINIMAL THERMO

QUBIKA THERMO

THERMO





L'utilizzo dei modelli termostatici può aiutare ad avere un maggiore controllo sul consumo di acqua e energia, risparmiando la quantità di acqua solitamente sprecata cercando la temperatura desiderata.

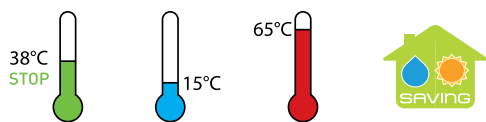

#### CARATTERISTICHE TECNICHE:

- Blocco di sicurezza: 38°C
- Campo di lavoro: da 15°C a 65°C
- Differenziale termico consigliato 50°C
- Campo di pressione in rete: da 1 a 5 bar dinamici
- Sistema di sicurezza con blocco dell'erogazione in caso di mancanza di una delle due acque
- Filtro in acciaio INOX per il trattamento delle impurità

#### SIMBOLOGIE:

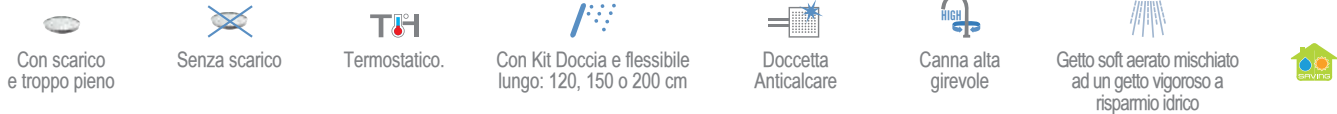

### LAVABI E BIDET



**H 10**  
Miscelatore termostatico lavabo con scarico.



**H 11**  
Miscelatore termostatico lavabo senza scarico.



**H 20**  
Miscelatore termostatico bidet con aeratore direzionabile con scarico.



**H 21**  
Miscelatore termostatico bidet con aeratore direzionabile senza scarico.



## VASCA E DOCCE

ELEGANCE

Q-ELEGANCE

MINIMAL THERMO

QUBIKA THERMO

THERMO



**H 05**

Miscelatore termostatico monoblocco vasca doccia senza set doccia.



**H 02**

Miscelatore termostatico monoblocco vasca doccia con set doccia.



**H 39**

Miscelatore termostatico doccia esterno con saliscendi.



**H 39 D**

Miscelatore termostatico doccia esterno con set doccia.



**H 31**

Miscelatore termostatico doccia esterno senza set doccia.



## CUCINA



**H 40**

Miscelatore termostatico per lavello con bocca alta girevole.



# Q-COLOR

## CARATTERISTICHE TECNICHE:

La serie è dotata di cartuccia a dischi ceramici, Ø 25 mm, prodotta da S.T.S.R. – Studio Tecnico Sviluppo e Ricerche - [www.stsr.it](http://www.stsr.it)

Q-COLOR

Q-AMBIENT

MINIMAL COLOR

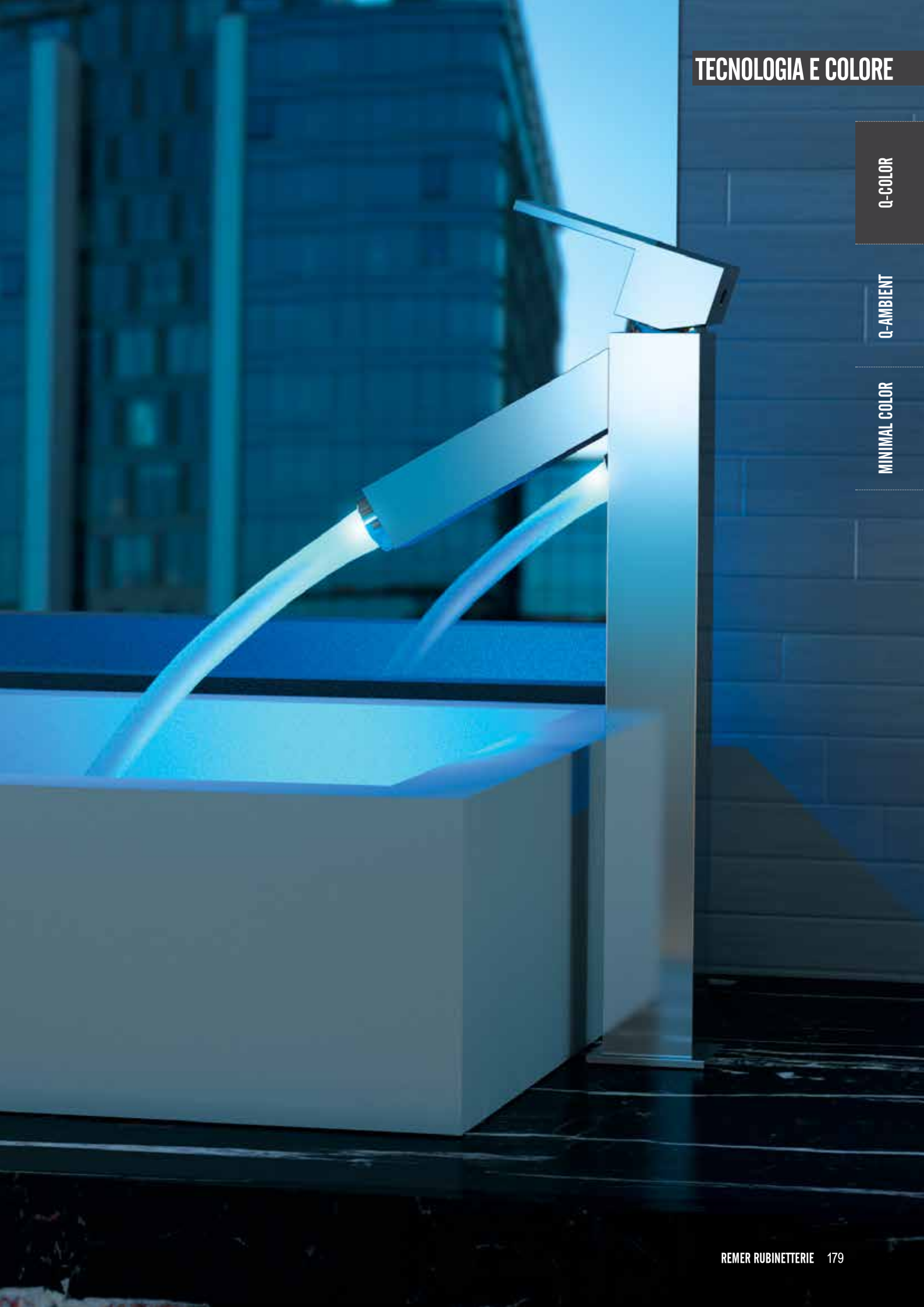

## Q-COLOR

## Q-COLOR

*Q-Color è il progetto Remer Rubinetterie che, partendo dallo studio di forme cubiche con base la cartuccia minimale da 25 mm, sviluppa un miscelatore dal design totalmente squadrato ma molto d'impatto, in cui le proporzioni sono concepite per riproporsi e donare alla serie una grande armonia tra le parti.*

*L'inserimento della cartuccia Color Fountain risulta essere il valore aggiunto che caratterizza questa linea.*

*L'emanazione di acqua illuminata e colorata avviene tramite questo dispositivo, dotato di luci a led, che non necessita di batterie o collegamenti alla corrente in quanto autoalimentato da un sistema interno a turbina.*

*Il Color Fountain, oltre a contenere un elemento termosensibile che a seconda dei modelli e della programmazione riconosce e segnala tramite diverso colore la temperatura dell'acqua, ha la possibilità di essere scelto in quattro modelli: la versione arcobaleno, una emozionante gamma cromatica in continua rotazione, la versione che segnala i passaggi di temperatura tramite il cambiamento dei colori rosso, giallo verde e blu, la versione soft che propone al cambio della temperatura i colori azzurro, bianco LED e rosa, e la versione totalmente bianco LED. Il dispositivo Color Fountain è, per completezza di informazione, interamente prodotto in Italia da S.T.S.R., azienda storica milanese sinonimo di alta qualità.*

*Q-Color unisce all'alto design la magia della luce e del colore per creare atmosfere sorprendenti.*



*Il design della serie è stato ideato dal designer Cristian Mapelli, parte del Dipartimento di Ricerca e Sviluppo del Gruppo Remer ed ingegnerizzata e prodotta nei nostri stabilimenti produttivi situati in provincia di Milano.*







La tecnologia COLOR LED LIGHT é disponibile in quattro varianti denominate A, B, C, D, di seguito dettagliate. Per evidenziare la Vostra scelta, aggiungere la lettera corrispondente a fine codice articolo.

Le temperature indicate possono variare di circa +/-2 gradi a seconda delle caratteristiche del miscelatore e dell'ambiente.  
I modelli A B e D oltre i 40° emaneranno luce di colore rosso come protezione.

**A**  La luce emanata è solo bianca

**B**    La luce emanata cambia colore al variare della temperatura  
Azzurro: fino a 32°  
Bianco : da 32° a 38°  
Rosa: oltre 38°

**C**     La luce emanata cambia colore al variare della temperatura  
Blu : fino a 28°  
Verde : da 28° a 33°  
Giallo: da 33° a 38°  
Rosso: da 38°

**D**         Un arcobaleno di colori e sfumature si alternano creando un continuo gioco emozionale



Q-COLOR

Q-AMBIENT

MINIMAL COLOR



**SIMBOLOGIE:**

-   
 Con scarico  
con troppo pieno
-   
 Senza scarico
-   
 Con Click-Clac
-   
 Con Click-Clac  
con Troppo Pieno
-   
 Con Luce  
Led
-   
 Proporzione  
perfetta.
-   
 Con Kit Doccia e flessibile  
lungo: 120, 150 o 200 cm
-   
 Doccetta  
estraibile
-   
 Getto ad ampia  
copertura effetto pioggia

**LAVABI**





**QR 10**  
Miscelatore monocomando lavabo.  
Altezza 194 mm, interasse 100 mm.





**QR 11**  
Miscelatore monocomando lavabo senza  
scarico.  
Altezza 194 mm, interasse 100 mm.





**QR 10 L**  
Miscelatore monocomando lavabo alto L, con  
scarico clic-clack con troppo pieno.  
Altezza 315 mm, interasse 118 mm.





**QR 11 L**  
Miscelatore monocomando lavabo alto L, senza  
scarico.  
Altezza 315 mm, interasse 118 mm.









**QR 10 LXL**  
Miscelatore monocomando lavabo alto LXL,  
con scarico click-clack con troppo pieno.  
Altezza 476 mm, interasse 118 mm.





**QR 11 LXL**  
Miscelatore monocomando lavabo alto LXL,  
senza scarico.  
Altezza 476 mm, interasse 118 mm.

**QR 18**  
Miscelatore monocomando lavabo da pavimento,  
con scarico click-clack con troppo pieno.  
Altezza 1061 mm, interasse 118 mm.



BIDET



**QR 20**  
Miscelatore monocomando bidet.



**QR 21**  
Miscelatore monocomando bidet, senza scarico.

Q-COLOR

Q-AMBIENT

MINIMAL COLOR

BOCCHIE ED INCASSI DOCCIA



**S 30 3**  
Miscelatore monocomando da incasso per doccia.



**S 09 3**  
Miscelatore monocomando da incasso con deviatore per vasca/doccia.



**91 QR**  
Bocca incasso.

VASCA E DOCCE ED INCASSI DOCCIA



**QR 02**  
Miscelatore vasca esterno con kit doccia.

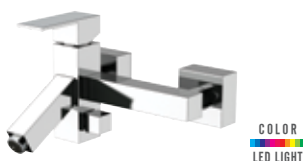

**QR 05**  
Miscelatore vasca esterno senza kit doccia.



**QR 07**  
Miscelatore monocomando bordo vasca con deviatore integrato nella bocca e doccetta estraibile in ottone cromato.

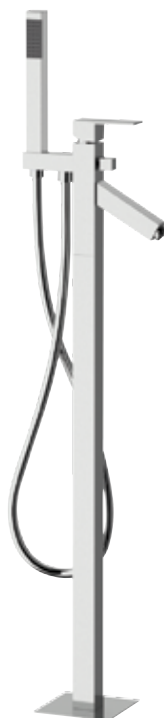

**QR 08**  
Miscelatore vasca da pavimento, con deviatore, senza scarico. Altezza 960 mm, interasse 118 mm.



**QR 39**  
Miscelatore doccia esterno con kit doccia.



**QR 31**  
Miscelatore doccia esterno senza kit doccia.

A glass vase with three dark reed diffusers is positioned in the lower-left corner of the frame. The background is a vibrant green wall with a textured surface. A dark horizontal band spans across the middle of the image, containing text. The overall composition is minimalist and modern.

# Q-AMBIENT

## CARATTERISTICHE TECNICHE:

La serie è dotata di cartuccia a dischi ceramici, Ø 25 mm, prodotta da S.T.S.R. – Studio Tecnico Sviluppo e Ricerche - [www.stsr.it](http://www.stsr.it)

Q-COLOR

Q-AMBIENT

MINIMAL COLOR





**SIMBOLOGIE:**

-   
 Con scarico con troppo pieno
-   
 Senza scarico
-   
 Con Click-Clack
-   
 Con Click-Clack con Troppo Pieno
-   
 Con tecnologia ambient led faucet
-   
 Proporzione perfetta.
-   
 Con Kit Doccia e flessibile lungo: 120, 150 o 200 cm
-   
 Canna alta girevole
-   
 Doccetta estraibile
-   
 Getto ad ampia copertura effetto pioggia
-   
 Con getto a cascata

**Q-AMBIENT LAVABI E BIDET**



**QA 10**

Miscelatore monocomando lavabo con dispositivo luminoso AMBIENT, scarico click-clack con troppo pieno.  
 Altezza 138 mm, interasse 115 mm.



**QA 10 L**

Miscelatore monocomando lavabo alto L con dispositivo luminoso AMBIENT, scarico click-clack con troppo pieno.  
 Altezza 230 mm, interasse 184 mm



**QA 10 LXL**

Miscelatore monocomando lavabo alto LXL con dispositivo luminoso AMBIENT, scarico click-clack con troppo pieno.  
 Altezza 275 mm, interasse 184 mm



**QA 11**

Miscelatore monocomando lavabo con dispositivo luminoso AMBIENT, senza scarico.  
 Altezza 138 mm, interasse 115 mm.



**QA 11 L**

Miscelatore monocomando lavabo alto L con dispositivo luminoso AMBIENT, senza scarico.  
 Altezza 230 mm, interasse 184 mm



**QA 11 LXL**

Miscelatore monocomando lavabo alto LXL con dispositivo luminoso AMBIENT, senza scarico.  
 Altezza 275 mm, interasse 184 mm

## Q-AMBIENT Q-DESIGN BORDO VASCA ED INCASSI DOCCIA

Q-COLOR

Q-AMBIENT

MINIMAL COLOR

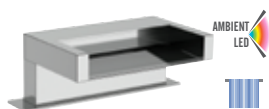

**91 QA**

Bocca a cascata bordo vasca con dispositivo luminoso AMBIENT.

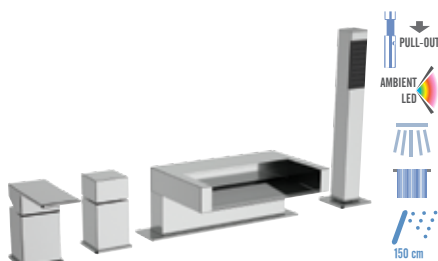

**QA 06**

Miscelatore monocomando bordo vasca con deviatore, doccetta estraibile in ottone cromato e bocca a cascata con dispositivo luminoso AMBIENT.



**QD 30**

Miscelatore doccia incasso.



**QD 09**

Miscelatore doccia incasso con deviatore.



## CUCINA



**QA 40**

Monocomando lavello con bocca girevole dotato di dispositivo luminoso AMBIENT.



**QKA 72**

Monocomando lavello bocca girevole, corpo quadrato, dotato di dispositivo luminoso AMBIENT con illuminazione sotto la bocca di erogazione.





# MINIMAL COLOR

## CARATTERISTICHE TECNICHE:

La cartuccia Color è prodotta in Italia da S.T.S.R., certificata CE ed interamente a norma. La cartuccia è dotata anche di filtro in entrata che permette alla turbina di lavorare isolata dalle impurità presenti nell'acqua ed alla cartuccia di essere pulita tipo un normale aeratore.



Q-COLOR

Q-AMBIENT

MINIMAL COLOR



**SIMBOLOGIE:**

Con scarico con troppo pieno



Senza scarico



Con Click-Clack



Con Click-Clack con Troppo Pieno



Proporzione perfetta.



Con Luce Led



Con tecnologia ambient led faucet



Con Kit Doccia e flessibile lungo: 120, 150 o 200 cm



Doccetta Anticalcare



Canna alta girevole



Doccetta estraibile



Getto con massaggio intenso a risparmio idrico



Getto Esterno



Getto spray delicato ad ampia copertura con getto vigoroso all'esterno a risparmio idrico



Massaggio con getto vigoroso concentrato



Getto aerato intenso



Getto ad ampia copertura effetto pioggia

**NEW**  
Prodotto novità

**CE**

CR = cromato

BO = bianco opaco

NO = nero opaco

**MANIGLIE:**

NR 10 1



NR 10 2



NR 10 3

**LAVABI E BIDET**

COLOR LED LIGHT  
PERFECT FINISH  
CE

**NR 10 2**

Miscelatore monocomando per lavabo con cartuccia con luce a led e scarico.  
Altezza 215 mm, interasse 100 mm.



COLOR LED LIGHT  
PERFECT FINISH  
CE

**NR 11 2**

Miscelatore monocomando per lavabo con cartuccia con luce a led, senza scarico.  
Altezza 215 mm, interasse 100 mm.



COLOR LED LIGHT  
OVERFLOW  
PERFECT FINISH  
CE

**NR 10 L 2**

Miscelatore monocomando alto L per lavabo con cartuccia con luce a led, su colonna, scarico click-clack con troppo pieno.  
Altezza 335 mm, interasse 145 mm.



COLOR LED LIGHT  
OVERFLOW  
PERFECT FINISH  
CE

**NR 10 L B 2**

Miscelatore monocomando alto L per lavabo con cartuccia con luce a led, su colonna, scarico click-clack.  
Altezza 335 mm, interasse 145 mm.



COLOR LED LIGHT  
PERFECT FINISH  
CE

**NR 11 L 2**

Miscelatore monocomando alto L per lavabo con cartuccia con luce a led, su colonna, senza scarico.  
Altezza 335 mm, interasse 145 mm.



COLOR LED LIGHT  
OVERFLOW  
PERFECT FINISH  
CE

**NR 10 LXL 2**

Miscelatore monocomando lavabo alto LXL con cartuccia con luce a led, su colonna, scarico click-clack con troppo pieno.  
Altezza 385 mm, interasse 145 mm.



COLOR LED LIGHT  
OVERFLOW  
PERFECT FINISH  
CE

**NR 10 LXL B2**

Miscelatore monocomando lavabo alto LXL con cartuccia con luce a led, su colonna, scarico click-clack.  
Altezza 385 mm, interasse 145 mm.



COLOR LED LIGHT  
PERFECT FINISH  
CE

**NR 11 LXL 2**

Miscelatore monocomando lavabo alto LXL con cartuccia con luce a led, su colonna, senza scarico.  
Altezza 385 mm, interasse 145 mm.



COLOR  
LED LIGHT

OVERFLOW

PERFECT  
FINISH

CE

## NR 18 2

Miscelatore monocomando lavabo da terra con cartuccia con luce a led, con scarico click-clack con troppo pieno.  
Altezza 1040 mm, interasse 175 mm.



## NR 17

Miscelatore da soffitto in ottone cromato lunghezza 166 cm, con miscelazione e controllo flusso integrati nella bocca di erogazione, e dispositivo color.

## NR 17 L

Miscelatore da soffitto in ottone cromato lunghezza 181 cm, con miscelazione e controllo flusso integrati nella bocca di erogazione, e dispositivo color.

## NR 17 LXL

Miscelatore da soffitto in ottone cromato lunghezza 231 cm, con miscelazione e controllo flusso integrati nella bocca di erogazione, e dispositivo color.

CE PERFECT FINISH COLOR LED LIGHT



COLOR  
LED LIGHT

PERFECT  
FINISH

CE

## NR 20 2

Miscelatore monocomando per bidet, con aeratore direzionabile, cartuccia con luce a led.



COLOR  
LED LIGHT

PERFECT  
FINISH

CE

## NR 21 2

Miscelatore monocomando per bidet, con aeratore direzionabile, cartuccia con luce a led, senza scarico.

## BOCCHIE



COLOR  
LED LIGHT

CE

## 91 NR

Bocca incasso per miscelatore vasca-doccia con cartuccia con luce a led, cm 18.



COLOR  
LED LIGHT

PERFECT  
FINISH

CE

## 91 V NR

Bocca da soffitto in ottone cromato lunghezza 166 cm, con dispositivo color.



COLOR  
LED LIGHT

PERFECT  
FINISH

CE

## 91 VL NR

Bocca da soffitto in ottone cromato lunghezza 181 cm, con dispositivo color.

Q-COLOR

Q-AMBIENT

MINIMAL COLOR

## MINIMAL COLOR

## MINIMAL COLOR

*La Minimal Color è realizzata per arricchire l'ambiente bagno di elementi con valore rigenerante.*

*La Cromoterapia è un metodo antichissimo usato per ristabilire equilibri fisici ed emozionali tramite l'uso e l'irradiazione del colore.*

*Seguendo questa ricerca, presentiamo i nostri miscelatori per la Cromoterapia come elementi che entrano nel quotidiano con semplicità grazie a nuove tecnologie che permettono di generare energia direttamente e continuamente tramite il flusso d'acqua in uscita dal miscelatore.*

*La luce bianca o multi-colore fuoriesce quindi come per magia dalle bocche di erogazione senza la necessità di impianti elettrici o di allacciamenti alla corrente.*

*La cartuccia interna è dotata di una turbina e di un sensore della temperatura.*

*Una terapia naturale ad energia pulita.*

*Il design della serie è stato ideato dal Gruppo di Ricerca e Sviluppo di Remer Rubinetterie ed ingegnerizzata e prodotta nei nostri stabilimenti produttivi situati in provincia di Milano.*

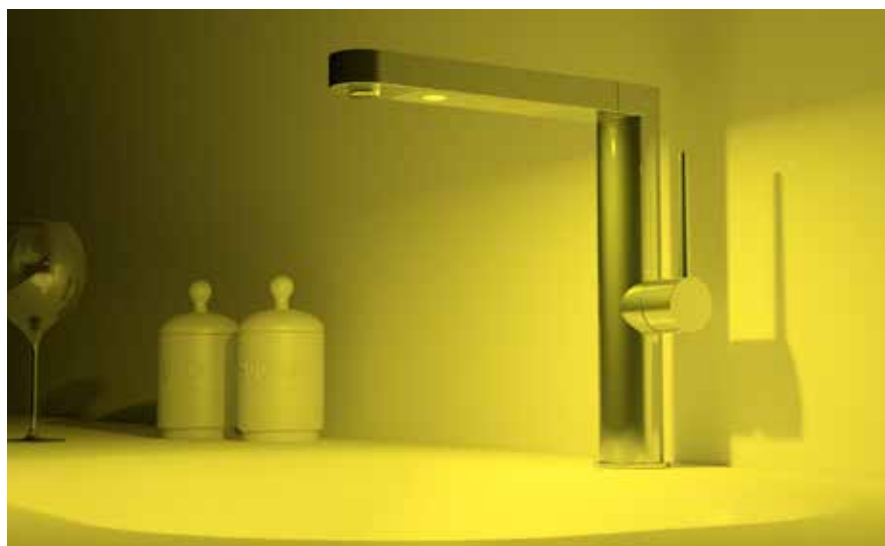









La tecnologia COLOR LED LIGHT é disponibile in quattro varianti denominate A, B, C, D, di seguito dettagliate. Per evidenziare la Vostra scelta, aggiungere la lettera corrispondente a fine codice articolo.

Le temperature indicate possono variare di circa +/-2 gradi a seconda delle caratteristiche del miscelatore e dell'ambiente.  
I modelli A B e D oltre i 40° emaneranno luce di colore rosso come protezione.

**A**   
La luce emanata è solo bianca

**B**     
La luce emanata cambia colore al variare della temperatura  
Azzurro: fino a 32°  
Bianco : da 32° a 38°  
Rosa: oltre 38°

**C**      
La luce emanata cambia colore al variare della temperatura  
Blu : fino a 28°  
Verde : da 28° a 33°  
Giallo: da 33° a 38°  
Rosso: da 38°

**D**         Un arcobaleno di colori e sfumature si alternano creando un continuo gioco emozionale



Q-COLOR

Q-AMBIENT

MINIMAL COLOR

## INCASSI



### N 09 L 2

Miscelatore monocomando da incasso con deviatore per vasca/doccia.

### N 09 B

Parte interna miscelatore monocomando incasso vasca/doccia con deviatore.

### N 09L E

Parte esterna miscelatore monocomando incasso vasca/doccia con deviatore.



### N 30 L 2

Miscelatore monocomando da incasso senza deviatore per vasca/doccia.

### N 30 B

Parte interna miscelatore monocomando incasso doccia.

### N 30L E

Parte esterna miscelatore monocomando incasso doccia.

## BOX INCASSO



NEW



### RR BOX

Box da incasso per miscelatore doccia con deviatore.

### N 30 2 KB

Set miscelatore doccia da abbinare al box incasso.



+



### RR BOX

Box da incasso per miscelatore doccia con deviatore.

### N 09 2 KB

Set miscelatore doccia con deviatore da abbinare al box incasso.



NEW



### RR BOX 93

Box da incasso per miscelatore doccia tre vie.

### N 93 2 KB

Set miscelatore doccia tre vie da abbinare al box incasso.



NEW



### RR BOX 92

Box da incasso per miscelatore doccia due vie.

### N 92 2 KB

Set miscelatore doccia due vie da abbinare al box incasso.



NEW



### RR BOX 93

Box da incasso per miscelatore doccia tre vie.

### N 93 7 2 KB

Set miscelatore doccia tre vie e sette posizioni da abbinare al box incasso.



## VASCA



**NR 02 2**

Miscelatore monocomando per vasca, esterno, con cartuccia con luce a led e doccia duplex.



**NR 07 2**

Miscelatore monocomando bordo vasca con cartuccia con luce a led, deviatore integrato nella bocca, bocca minimale e doccetta estraibile minimale in ottone cromato.



**NR 05 2**

Miscelatore monocomando per vasca, esterno, con cartuccia con luce a led, senza doccia.



**NR 08 2**

Miscelatore vasca da pavimento con cartuccia con luce a led, con deviatore e kit doccia, senza scarico. Altezza 920 mm, interasse 135 mm.

Q-COLOR

Q-AMBIENT

MINIMAL COLOR

## CUCINA

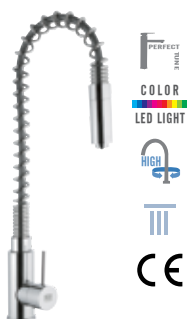

**NR 75 2**

Miscelatore monocomando laterale per lavello, alto, con base tonda e doccetta monogetto con luce led, bocca girevole a molla in acciaio inox elettrolucidata, flessibile in acciaio inox ricoperto in pvc metallizzato e doccetta monogetto. Materiale: miscelatore in ottone cromato, doccetta in ottone cromato.



**NR 77 2**

Miscelatore monocomando laterale per lavello alto, con base tonda e doccetta monogetto con luce led, bocca girevole a molla in acciaio inox elettrolucidata, flessibile e doccetta monogetto.

Materiale: miscelatore in ottone cromato, molla in acciaio inox, flessibile in acciaio inox ricoperto in pvc metallizzato argento, doccetta in ottone cromato. Interasse miscelatore/doccetta: regolabile da cm 20 a cm 30 (regolazione sull'asta).



**NR 75S 2**

Miscelatore monocomando con base tonda e doccetta monogetto con luce led.

## AMBIENT



**NA 40**

Miscelatore monocomando lavello, con bocca girevole, dotato di dispositivo luminoso AMBIENT.



**NKA 72**

Miscelatore monocomando lavello, con bocca girevole, corpo tondo, dotato di dispositivo luminoso AMBIENT, con illuminazione sotto la bocca di erogazione.

# FLASH

## CARATTERISTICHE TECNICHE:

La serie è dotata di cartuccia a dischi ceramici, Ø 25 mm, prodotta da S.T.S.R. – Studio Tecnico Sviluppo e Ricerche - [www.stsr.it](http://www.stsr.it)







**SIMBOLOGIE:**

- |   |   |  |   |   |  |  |  |
|---|---|--|---|---|--|--|--|
| <br>Con scarico con troppo pieno | <br>Senza scarico          | <br>Con Click-Clack   | <br>Con Click-Clack con Troppo Pieno         | <br>Proporzione perfetta                       | <br>Con Kit Doccia e flessibile lungo: 120, 150 o 200 cm | <br>Corpo girevole              | <br>Doccetta estraibile |
|   | <br>Con getto a cascata. | <br>Con multigetto. | <br>Ampio getto pioggia a risparmio idrico | <br>Getto ad ampia copertura effetto pioggia | <br>Massaggio con getto vigoroso concentrato          | <br>Risparmio idrico 6 l/min. |  |

**LAVABI**

**Z 10**  
Miscelatore monocomando lavabo con scarico.  
Altezza 180 mm, interasse 142 mm.



**Z 11**  
Miscelatore monocomando lavabo, senza scarico.  
Altezza 180 mm, interasse 142 mm.



**ZC 10**  
Miscelatore monocomando lavabo con scarico.  
Altezza 180 mm, interasse 107 mm.



**ZC 11**  
Miscelatore monocomando lavabo, senza scarico.  
Altezza 180 mm, interasse 107 mm.



**Z 18**  
Miscelatore monocomando lavabo da pavimento con scarico click-clack con troppo pieno.  
Altezza 940 mm, interasse 120 mm.





**ZC 10 L**

Miscelatore monocomando lavabo alto L con scarico click-clack con troppo pieno. Altezza 270 mm, interasse 100 mm.



**ZC 10 LB**

Miscelatore monocomando lavabo alto L con scarico click-clack. Altezza 270 mm, interasse 100 mm.



**ZC 11 L**

Miscelatore monocomando lavabo alto L senza scarico. Altezza 270 mm, interasse 100 mm.

## BIDET



**Z 20**

Miscelatore monocomando bidet con aeratore direzionabile.



**Z 21**

Miscelatore monocomando bidet con aeratore direzionabile, senza scarico.



**Z 60**

Set miscelatore incasso shut-off con flessibile doccia cm 120.



**Z 63**

Miscelatore incasso per shut-off.

## VASCA



**ZC 02**

Miscelatore monocomando per vasca, esterno, con bocca a cascata e con set doccia.



**ZC 05**

Miscelatore monocomando per vasca, esterno, con bocca a cascata, senza set doccia.



**Z 07**

Miscelatore monocomando bordo vasca con deviatore integrato nella bocca quadra, e doccetta quadrata estraibile in ottone cromato.

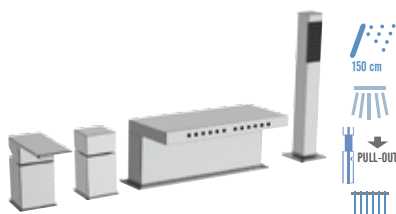

**Z 06**

Miscelatore monocomando bordo vasca con deviatore, bocca con effetto multigetto e doccetta estraibile in ottone cromato.

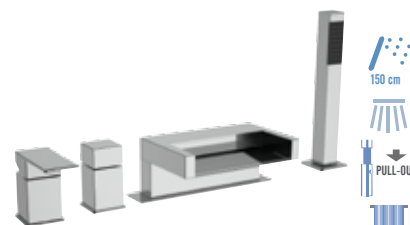

**ZC 06**

Miscelatore monocomando bordo vasca con deviatore, bocca cascata e doccetta estraibile in ottone cromato.



FLASH

## DOCCE



**Z 39**

Miscelatore monocomando esterno doccia, con set doccia.



**Z 31**

Miscelatore monocomando esterno doccia, senza set doccia.

## INCASSI DOCCIA



**Z 30**

Miscelatore monocomando da incasso senza deviatore.

**N 30 B**

Parte interna miscelatore monocomando incasso doccia.

**Z 30 E**

Parte esterna miscelatore monocomando incasso doccia.



**Z 09**

Miscelatore monocomando da incasso con deviatore per vasca/doccia.

**N 09 B**

Parte interna miscelatore monocomando incasso vasca/doccia con deviatore.

**Z 09 E**

Parte esterna miscelatore monocomando incasso vasca/doccia con deviatore.



**Z 92**

Miscelatore monocomando per doccia, con deviatore a due posizioni (due uscite ed una entrata) su piastra unica.



**Z 93**

Miscelatore monocomando per doccia con deviatore a tre vie (una entrata e tre uscite) su piastra unica.



**Z 93 7**

Miscelatore monocomando per doccia con deviatore a tre vie e sette posizioni (una entrata, tre uscite e sette posizioni con cui selezionare uscite singole o miscelate tra loro) su unica piastra.



**Z 94**

Miscelatore monocomando per doccia, con deviatore a 4 posizioni (4 uscite ed 1 entrata) su piastra unica.



**Z 95**

Miscelatore monocomando per doccia, con deviatore a 5 posizioni (5 uscite ed una entrata) su piastra unica.



**Z 94 C**

Miscelatore monocomando per doccia, con deviatore a 4 posizioni (4 uscite ed una entrata) su doppia piastra, con possibilità di chiusura del flusso dal deviatore durante il cambio di posizione.



**Z 95 C**

Miscelatore monocomando per doccia, con deviatore a 5 posizioni (5 uscite ed una entrata) su doppia piastra, con possibilità di chiusura del flusso dal deviatore durante il cambio di posizione.



BOX INCASSO



NEW

+



**RR BOX**

Box da incasso per miscelatore doccia con deviatore.

**Z 30 KB**

Set miscelatore doccia da abbinare al box incasso.



+



**RR BOX**

Box da incasso per miscelatore doccia con deviatore.

**Z 09 KB**

Set miscelatore doccia con deviatore da abbinare al box incasso.



NEW

+



**RR BOX93**

Box da incasso per miscelatore doccia tre vie.

**Z 93 KB**

Set miscelatore doccia tre vie da abbinare al box incasso.



NEW

+



**RR BOX92**

Box da incasso per miscelatore doccia due vie.

**Z 92 KB**

Set miscelatore doccia due vie da abbinare al box incasso.



NEW

+



**RR BOX93**

Box da incasso per miscelatore doccia tre vie.

**Z 93 7 KB**

Set miscelatore doccia tre vie e sette posizioni da abbinare al box incasso.

BOCCHIE



**91 ZC**

Bocca incasso a cascata.

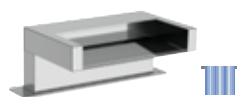

**91 ZCA**

Bocca bordo vasca getto a cascata.



**91 ZCF**

Bocca bordo vasca con effetto multigetto.



FLASH



## WELLNESS

### Z 93 7 S02

Set doccia composto da:  
 Art. 359 ZC: Soffione doccia con getto a cascata completamente in ottone cromato.  
 Art. Q 34 JET: 6 getti Q idromassaggio anticalcare.  
 Art. 337S 317RR 333CN150: Presa acqua con supporto doccia duplex, doccetta flat e flessibile conico cm 150 il tutto in ottone cromato.  
 Z 93 7: Miscelatore monocomando incasso con deviatore a tre vie e sette posizioni su piastra unica.



### Z 93 7 S03

Set doccia composto da:  
 Art. 359 ZC: Soffione doccia con getto a cascata completamente in ottone cromato.  
 Art. 337S 317RR 333CN150: Presa acqua con supporto doccia duplex, doccetta flat e flessibile conico cm 150 il tutto in ottone cromato.  
 Z 93 7: Miscelatore monocomando incasso con deviatore a tre vie e sette posizioni su piastra unica.  
 Art. 91 ZC: bocca incasso con getto a cascata completamente in ottone cromato.





## Z 09 S02

Set doccia composto da:  
 Art. 359 ZC: Soffione doccia con getto a cascata completamente in ottone cromato.  
 Art. 337S 317RR 333CN150: Presa acqua deluxe in ottone cromato, doccetta flat in ottone cromato e flessibile doccia conico in ottone cromato.  
 Art. Z 09: Miscelatore monocomando incasso per doccia con deviatore.



## Z 93 7 S01

Set doccia composto da:  
 Art. 359 ZC: Soffione doccia con getto a cascata completamente in ottone cromato.  
 Art. Q 34 JET: 6 getti Q idromassaggio anticalcare.  
 Art. 317R 317RR: Saliscendi e doccetta tutto in ottone cromato, serie ultrapiatta rettangolare minimale lusso coN flessibile 333CN cm 150.  
 Z 93 7: Miscelatore monocomando incasso con deviatore a tre vie e sette posizioni su piastra unica.  
 Art. 309S: Presa acqua quadrata in ottone cromato.



## Z 93 7 S01 UFCA

Set doccia composto da:  
 Art. 350 UF CA: Soffione doccia ultrapiatto 50x25 cm, a parete in acciaio INOX lucidato a specchio, 2 getti, pioggia e cascata.  
 Art. 317R 317RR: Saliscendi e doccetta tutto in ottone cromato, serie ultrapiatta rettangolare minimale lusso coN flessibile 333CN cm 150.  
 Art. Z 93 7: Miscelatore monocomando per doccia con deviatore a tre vie e sette posizioni su piastra unica.  
 Art. 309S: Presa acqua quadrata in ottone cromato.



## Z 09 S01 UF

Set doccia composto da:  
 Art. 350 UF: Soffione doccia ultrapiatto 50x25 cm, a parete in acciaio INOX lucidato a specchio, 1 getto pioggia.  
 Art. 317R 317RR: Saliscendi e doccetta tutto in ottone cromato, serie ultrapiatta rettangolare minimale lusso coN flessibile 333CN cm 150.  
 Art. Z 09: Miscelatore monocomando da incasso con deviatore per vasca/doccia.  
 Art. 309S: Presa acqua quadrata in ottone cromato.



## Z 93 7 S02 UFCA

Set doccia composto da:  
 Art. 350 UF CA: Soffione doccia ultrapiatto 50x25 cm, a parete in acciaio INOX lucidato a specchio, 2 getti, pioggia e cascata.  
 Art. 337S 317RR 333CN150: Presa acqua deluxe in ottone cromato, doccetta flat in ottone cromato e flessibile doccia conico in ottone cromato.  
 Art. Z 93 7: Miscelatore monocomando per doccia con deviatore a tre vie e sette posizioni su piastra unica.



## Z 09 S02 UF

Set doccia composto da:  
 Art. 350 UF: Soffione doccia ultrapiatto 50x25 cm, a parete in acciaio INOX lucidato a specchio, 1 getto pioggia.  
 Art. 337S 317RR 333CN150: Presa acqua deluxe in ottone cromato, doccetta flat in ottone cromato e flessibile doccia conico in ottone cromato.  
 Art. Z 09: Miscelatore monocomando da incasso con deviatore per vasca/doccia.



## CUCINA



## Z 40

Miscelatore monocomando per lavello con corpo girevole.



# QUBIKA CASCATA

## CARATTERISTICHE TECNICHE:

La serie è dotata di cartuccia a dischi ceramici, Ø 35 mm, prodotta da S.T.S.R. – Studio Tecnico Sviluppo e Ricerche - [www.stsr.it](http://www.stsr.it).  
Finiture disponibili: cromo, bianco opaco, nero opaco.

KEMER

DESIGN WATERFALL

FLASH

QUBIKA CASCATA





**SIMBOLOGIE:**

**LAVABI**



**QC 10**  
Miscelatore monocomando per lavabo con scarico.  
Altezza 155 mm, interasse 138 mm.



**QC 11**  
Miscelatore monocomando per lavabo senza scarico.  
Altezza 155 mm, interasse 138 mm.

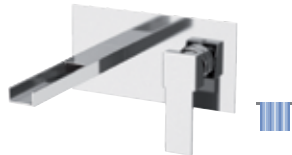

**QC 14**  
Miscelatore monocomando a incasso per lavabo, con piastra verticale rettangolare in ottone cromato e bocca a cascata squadrata lunghezza 19 cm.



**QC 15**  
Miscelatore monocomando a incasso per lavabo, con piastra verticale rettangolare in ottone cromato e bocca a cascata squadrata lunghezza 19 cm.

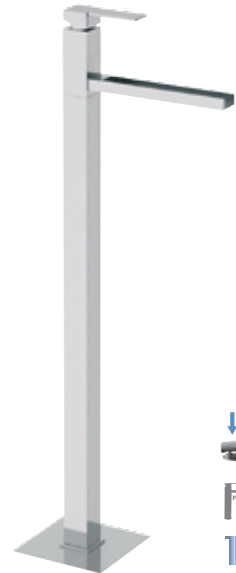

**QC 18**  
Miscelatore monocomando lavabo da pavimento, con scarico click-clack con troppo pieno.  
Altezza 1010 mm, interasse 150 mm.



**QC 10 L**  
Miscelatore monocomando alto L per lavabo con scarico click-clack con troppo pieno.  
Altezza 315 mm, interasse 150 mm.



**QC 10 LB**  
Miscelatore monocomando alto L per lavabo con scarico click-clack.  
Altezza 315 mm, interasse 150 mm.



**QC 11 L**  
Miscelatore monocomando lavabo alto L senza scarico.  
Altezza 315 mm, interasse 150 mm.



**QC 10 LXXL**  
Miscelatore monocomando lavabo extra alto XXL, con scarico click-clack e troppo pieno.  
Altezza 540 mm, interasse 150 mm.



**QC 11 LXXL**  
Miscelatore monocomando lavabo extra alto XXL senza scarico.  
Altezza 540 mm, interasse 150 mm.



## BIDET



**Q 20**  
Miscelatore monocomando per bidet, con aeratore direzionabile e tettuccio di protezione, con scarico.



**Q 21**  
Miscelatore monocomando per bidet, con aeratore direzionabile e tettuccio di protezione, senza scarico.

## VASCA



**QC 02**  
Miscelatore monocomando per vasca, esterno, con bocca a cascata, con doccia duplex.



**QC 05**  
Miscelatore monocomando per vasca, esterno, con bocca a cascata, senza set doccia.



**QC 08**  
Miscelatore vasca da pavimento, con doccetta 317RR in ottone cromato, con bocca a cascata, deviatore e kit doccia. Altezza 900 mm, interasse 183 mm.

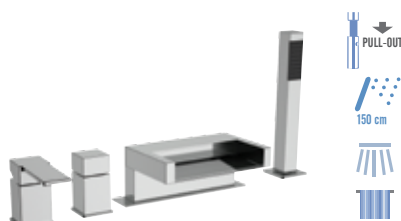

**Q 06**  
Miscelatore monocomando bordo vasca con deviatore, bocca cascata e doccetta in ottone cromato



**Q 06**  
Miscelatore monocomando bordo vasca con deviatore, bocca con effetto multigetto e doccetta in ottone cromato.

## BOCCE



**91 QC**  
Bocca incasso a cascata.



**91 ZC**  
Bocca incasso a cascata.

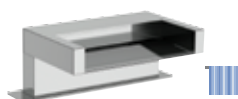

**91 ZCA**  
Bocca bordo vasca getto cascata.



**91 ZCF**  
Bocca bordo vasca multigetto.

## QUBIKA CASCATA

## QUBIKA CASCATA

*Con la sua forza vitale, la cascata è il simbolo di rigenerazione per eccellenza. Il suo correre ci riporta in luoghi naturali e accompagna la mente in fantasie e rituali di benessere.*

*Qubika Cascata, nata sulle linee di Qubika, ci porta in una nuova condizione di relax nell'uso di oggetti del quotidiano, riequilibrando attraverso la freschezza, il suono e la purezza dell'elemento vitale, l'acqua.*

*Il design della serie è stato ideato dal Gruppo di Ricerca e Sviluppo di Remer Rubinetterie ed ingegnerizzata e prodotta nei nostri stabilimenti produttivi situati in provincia di Milano.*

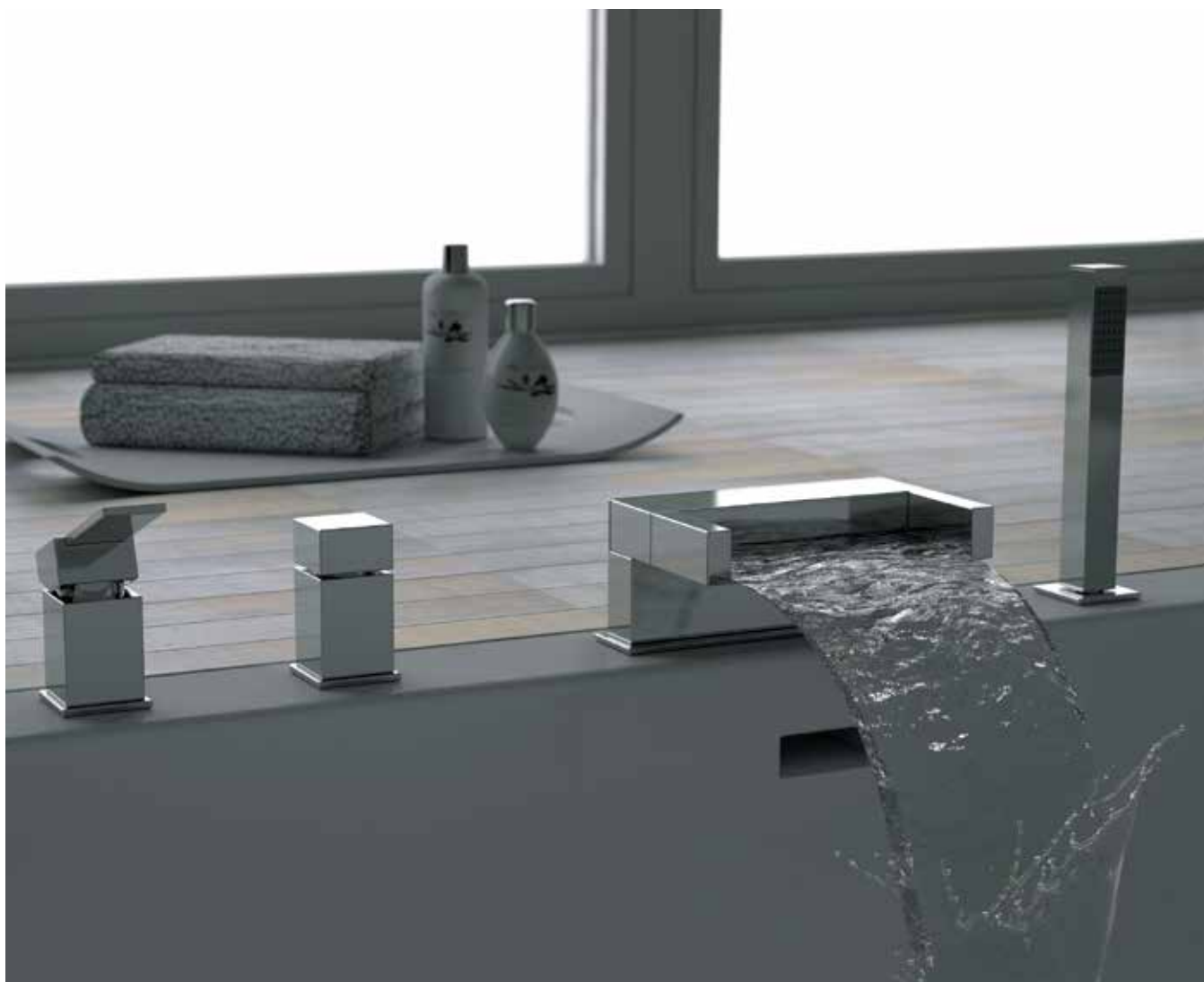

FLASH

QUBIKA CASCATA



**WELLNESS**



**QC 93 7 S33**

Set doccia composto da:  
 Art. 359 ZC: Soffione doccia con getto a cascata.  
 Art. 317SQ 337S: Set doccia duplex anticalcare SQ con presa acqua.  
 Art. 91 QC: Bocca incasso a cascata serie QC.  
 Art. Q 93 7: Miscelatore monocomando per doccia con deviatore a tre vie e sette posizioni su unica piastra



Set doccia composto da:  
 Art. 359SS: soffione anticalcare a pioggia rettangolare completamente in ottone 20x20 cm.  
 Braccio doccia quadrato in ottone cromato, cm 30.  
 Art. 317SQ 337S: Set doccia duplex anticalcare SQ con presa acqua.  
 Art. 91 QC: Bocca incasso a cascata serie QC.  
 Art. Q 93 7: Miscelatore monocomando per doccia con deviatore a tre vie e sette posizioni su unica piastra

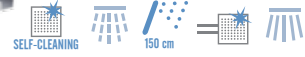

CODICE	DESCRIZIONE
<b>QC 93 7 S03</b>	Con art. 348S: braccio doccia a parete quadrato in ottone cromato, lunghezza 30 cm.
<b>QC 93 7 S23</b>	Con art. 347S: braccio doccia a soffitto quadrato in ottone cromato, lunghezza 30 cm.



**QC 94 S03 UFCA**

Set doccia composto da:  
 Art. 350UFCA: soffione doccia ultrapiatto 50x25 cm, a parete in acciaio INOX lucidato a specchio, 2 getti, pioggia e cascata.  
 Art. 317SQ 337S: Set doccia duplex anticalcare SQ con presa acqua.  
 Art. 91 QC: Bocca incasso a cascata serie QC.  
 Art. Q 94: Miscelatore monocomando per doccia con deviatore a quattro posizioni su piastra unica.



**QC 94 S03 SSSCA**

Set doccia composto da:  
 Art. 350SSCA: Soffione doccia a parete in acciaio INOX lucidato a specchio 50x20 cm, 2 getti, pioggia e cascata.  
 Art. 317SQ 337S: Set doccia duplex anticalcare SQ con presa acqua.  
 Art. 91 QC: Bocca incasso a cascata serie QC.  
 Art. Q 94: Miscelatore monocomando per doccia con deviatore a quattro posizioni su piastra unica.



**QC 95 S04 UFCA**

Set doccia composto da:  
 Art. 350UFCA: soffione ultrapiatto doccia 50x25 cm, a parete in acciaio INOX lucidato a specchio, 2 getti, pioggia e cascata.  
 Art. 317S 317SQ: Saliscendi quadro con doccetta Q anticalcare e flessibile conico in ottone cromato.  
 Art. 309 S: Presa acqua lusso quadrata.  
 Art. 91 QC: Bocca incasso a cascata serie QC.  
 Art. Q34 JET: 6 getti anticalcare SQ in ottone cromato.  
 Art. Q 95: Miscelatore monocomando per doccia, con deviatore a 5 posizioni su piastra singola.



**QC 95 S04 SSSCA**

Set doccia composto da:  
 Art. 350 SS CA: Soffione doccia a parete in acciaio INOX lucidato a specchio 50x20 cm, 2 getti, pioggia e cascata.  
 Art. 317S 317SQ: Saliscendi quadro con doccetta Q anticalcare e flessibile conico in ottone cromato.  
 Art. 309 S: Presa acqua lusso quadrata.  
 Art. 91 QC: Bocca incasso a cascata serie QC.  
 Art. Q34 JET: 6 getti anticalcare SQ in ottone cromato.  
 Art. Q 95: Miscelatore monocomando per doccia, con deviatore a 5 posizioni su piastra singola.



WELLNESS CASCATA TERMOSTATICO

FLASH

QUBIKA CASCATA



Set doccia composto da:  
 Art. 359SS: soffione anticalcare a pioggia rettangolare completamente in ottone 20x20 cm. Braccio doccia quadrato in ottone cromato, cm 30.  
 Art. 317 SQ 337S: Set doccia duplex anticalcare SQ con presa acqua.  
 Art. 91 QC: Bocca incasso a cascata serie QC.  
 Art. QT 93 7: Miscelatore monocomando termostatico per doccia con deviatore a tre vie e sette posizioni su piastra unica.



QTC 93 7 S33

Set doccia composto da:  
 Art. 359 ZC: Soffione doccia con getto a cascata.  
 Art. 317 SQ 337S: Set doccia duplex anticalcare SQ con presa acqua.  
 Art. 91 QC: Bocca incasso a cascata serie QC.  
 Art. QT 93 7: Miscelatore monocomando termostatico per doccia con deviatore a tre vie e sette posizioni su piastra unica.

CODICE	DESCRIZIONE
QTC 937 S03	Con art. 348S: braccio doccia a parete quadrato in ottone cromato, lunghezza 30 cm.
QTC 937 S23	Con art. 347S: braccio doccia a soffito quadrato in ottone cromato, lunghezza 30 cm.



QTC 94 S03 UFCA

Set doccia composto da:  
 Art. 350UFCA: soffione doccia ultrapiatto 50x25 cm, a parete in acciaio INOX lucidato a specchio, 2 getti, pioggia e cascata.  
 Art. 317SQ 337S: Set doccia duplex anticalcare SQ con presa acqua.  
 Art. 91 QC: Bocca incasso a cascata serie QC.  
 Art. QT 94: Miscelatore monocomando termostatico per doccia con deviatore a quattro posizioni su piastra unica.



QTC 94 S03 SSSCA

Set doccia composto da:  
 Art. 350SSCA: Soffione doccia a parete in acciaio INOX lucidato a specchio 50x20 cm, 2 getti, pioggia e cascata.  
 Art. 317SQ 337S: Set doccia duplex anticalcare SQ con presa acqua.  
 Art. 91 QC: Bocca incasso a cascata serie QC.  
 Art. QT 94: Miscelatore monocomando termostatico per doccia con deviatore a quattro posizioni su piastra unica.



QTC 95 S04 UFCA

Set doccia composto da:  
 Art. 350UFCA: soffione doccia ultrapiatto 50x25 cm, a parete in acciaio INOX lucidato a specchio, 2 getti, pioggia e cascata.  
 Art. 317S 317SQ: Saliscendi quadro con doccetta Q anticalcare e flessibile conico in ottone cromato.  
 Art. 309 S: Presa acqua lusso quadrata.  
 Art. 91 QC: Bocca incasso a cascata serie QC.  
 Art. Q34 JET: 6 getti anticalcare SQ in ottone cromato.  
 Art. QT 95: Miscelatore monocomando termostatico per doccia, con deviatore a 5 posizioni su piastra singola.

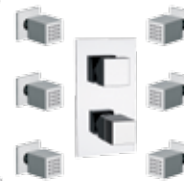

QTC 95 S04 SSSCA

Set doccia composto da:  
 Art. 350 SS CA: Soffione doccia a parete in acciaio INOX lucidato a specchio 50x20 cm, 2 getti, pioggia e cascata.  
 Art. 317S 317SQ: Saliscendi quadro con doccetta Q anticalcare e flessibile conico in ottone cromato.  
 Art. 309 S: Presa acqua lusso quadrata.  
 Art. 91 QC: Bocca incasso a cascata serie QC.  
 Art. Q34 JET: 6 getti anticalcare SQ in ottone cromato.  
 Art. QT 95: Miscelatore monocomando termostatico per doccia, con deviatore a 5 posizioni su piastra singola.



# LIBERTY

## CARATTERISTICHE TECNICHE:

La serie è normalmente dotata di vitoni tradizionali, a richiesta è disponibile anche con vitoni ceramici S.T.S.R. - [www.stsr.it](http://www.stsr.it).

Finiture disponibili: cromo, cromo-oro, bianco, bianco-oro.







**SIMBOLOGIE:**

-   
Con scarico e troppo pieno
-   
Senza scarico
-   
Con Click-Clack con Troppo Pieno
-   
Proporzione perfetta.
-   
Con Kit Doccia e flessibile lungo: 120, 150 o 200 cm
-   
Colonna doccia girevole.
-   
Canna girevole
-   
Canna alta girevole
-   
Doccetta estraibile
-   
Ampio getto pioggia a risparmio idrico
-   
Getto ad ampia copertura effetto pioggia



Disponibile anche con vitone ceramico; aggiungere CE alla fine del codice.



**71 LI**  
Maniglia.

€ 13,00

**LAVABI**

Batteria lavabo/lavello da incasso.

ARTICOLO	10 LI	10 LI CE
FINITURA	VITONE TRADIZIONALE	VITONE CERAMICO



Batteria lavabo con scarico 1"1/4.

ARTICOLO	11 LI	11 LI CE
FINITURA	VITONE TRADIZIONALE	VITONE CERAMICO



Batteria lavabo con bocca a "C" e scarico 1"1/4.

ARTICOLO	11 C LI	11 C LI CE
FINITURA	VITONE TRADIZIONALE	VITONE CERAMICO



Monofovo lavabo con scarico 1"1/4.

ARTICOLO	13 LI	13 LI CE
FINITURA	VITONE TRADIZIONALE	VITONE CERAMICO



Monofovo lavabo.

ARTICOLO	13 LI B	13 LI B CE
FINITURA	VITONE TRADIZIONALE	VITONE CERAMICO



Miscelatore tradizionale monofovo per lavabo serie Liberty, con canna antica.

ARTICOLO	13 A LI	13 A LI CE
FINITURA	VITONE TRADIZIONALE	VITONE CERAMICO



Miscelatore tradizionale monofovo per lavabo serie Liberty, con canna fusa.

ARTICOLO	13 C LI	13 C LI CE
FINITURA	VITONE TRADIZIONALE	VITONE CERAMICO



Miscelatore tradizionale monofovo per lavabo serie Liberty, con canna alta.

ARTICOLO	13 G LI	13 G LI CE
FINITURA	VITONE TRADIZIONALE	VITONE CERAMICO



Miscelatore tradizionale monofovo per lavabo serie Liberty, con canna tubo.

ARTICOLO	13 U LI	13 U LI CE
FINITURA	VITONE TRADIZIONALE	VITONE CERAMICO



Gruppo lavabo tipo a ponte, canna Ø18 cm.

ARTICOLO	14 LI	14 LI CE
FINITURA	VITONE TRADIZIONALE	VITONE CERAMICO

BIDET



Batteria bidet con scarico automatico 1"1/4.

ARTICOLO	21 LI	21 LI CE
FINITURA	VITONE TRADIZIONALE	VITONE CERAMICO



Batteria bidet con doccia e scarico 1"1/4.

ARTICOLO	22 LI	22 LI CE
FINITURA	VITONE TRADIZIONALE	VITONE CERAMICO



Monoforo bidet con scarico automatico 1"1/4.

ARTICOLO	23 LI	23 LI CE
FINITURA	VITONE TRADIZIONALE	VITONE CERAMICO

VASCA



Gruppo vasca con doccia duplex.

ARTICOLO	02 LI	02 LI CE
FINITURA	VITONE TRADIZIONALE	VITONE CERAMICO



Gruppo vasca esterno su colonnette alte Liberty, con doccia.

ARTICOLO	02 LI UK	02 LI CE UK
FINITURA	VITONE TRADIZIONALE	VITONE CERAMICO



Gruppo vasca senza doccia duplex.

ARTICOLO	05 LI	05 LI CE
FINITURA	VITONE TRADIZIONALE	VITONE CERAMICO



Bordo vasca.

ARTICOLO	06 LI	06 LI CE
FINITURA	VITONE TRADIZIONALE	VITONE CERAMICO



Batteria vasca incasso.

ARTICOLO	03 LI S01	03 LI CE S01
FINITURA	VITONE TRADIZIONALE	VITONE CERAMICO



Batteria vasca incasso.

ARTICOLO	03 LI S02	03 LI CE S02
FINITURA	VITONE TRADIZIONALE	VITONE CERAMICO



Gruppo vasca esterno su colonne da pavimento Liberty, con doccia.

ARTICOLO	<b>01 LI</b>	<b>01 LI CE</b>
FINITURA	VITONE TRADIZIONALE	VITONE CERAMICO



**88 01 LI**  
Colonne da pavimento Liberty.



**88 01 LI S**  
Coppia colonne vasca in ottone cromato, serie Liberty, con supporto doccia, 3/4M x 3/4M.



Gruppo vasca esterno con doccia duplex e canna lunga girevole 40 cm.

ARTICOLO	04 LI	04 LI CE
FINITURA	VITONE TRADIZIONALE	VITONE CERAMICO



Gruppo vasca con deviatore e attacco 3/4M.

ARTICOLO	07 LI	07 LI CE
FINITURA	VITONE TRADIZIONALE	VITONE CERAMICO



Gruppo vasca con colonna doccia lusso e soffione doccia in ottone cromato.

ARTICOLO	08 LI	08 LI CE
FINITURA	VITONE TRADIZIONALE	VITONE CERAMICO



Miscelatore vasca-doccia serie Liberty con colonna saliscendi con deviatore e doccetta Liberty con flessibile e soffione doccia a campanella. Tutti gli elementi sono esclusivamente in ottone cromato.

ARTICOLO	09 LI	09 LI CE
FINITURA	VITONE TRADIZIONALE	VITONE CERAMICO

LIBERTY

MUSA

1000-2000

## DOCCE



Gruppo doccia con colonna lusso e soffione doccia a campanella, tutto in ottone cromato.

ARTICOLO	36 LI	36 LI CE
FINITURA	VITONE TRADIZIONALE	VITONE CERAMICO



Gruppo doccia con colonna saliscendi e deviatore, completa di doccetta con flessibile e soffione a campanella, tutto in ottone cromato.

ARTICOLO	37 LI	37 LI CE
FINITURA	VITONE TRADIZIONALE	VITONE CERAMICO



### 317L 323CR

Saliscendi Liberty lusso, completamente in ottone cromato, con asta tonda e doccetta in ottone cromato modello Liberty.





Gruppo doccia a muro con attacco superiore 3/4"™.

ARTICOLO	<b>35 LI</b>	<b>35 LI CE</b>
FINITURA	VITONE TRADIZIONALE	VITONE CERAMICO



Gruppo doccia a muro, senza kit doccia.

ARTICOLO	<b>38 LI</b>	<b>38 LI CE</b>
FINITURA	VITONE TRADIZIONALE	VITONE CERAMICO



Gruppo doccia a muro con doccia duplex.

ARTICOLO	<b>39 LI</b>	<b>39 LI CE</b>
FINITURA	VITONE TRADIZIONALE	VITONE CERAMICO



**LV 30**

Miscelatore monocomando da incasso senza deviatore.



**LV 09**

Miscelatore monocomando da incasso con deviatore per vasca/doccia.

## CUCINA



Gruppo lavello a muro con canna inferiore.

ARTICOLO	<b>41 LI</b>	<b>41 LI CE</b>
FINITURA	VITONE TRADIZIONALE	VITONE CERAMICO



Gruppo lavello a muro con canna superiore.

ARTICOLO	<b>41 S LI</b>	<b>41 S LI CE</b>
FINITURA	VITONE TRADIZIONALE	VITONE CERAMICO



Gruppo lavello a muro con canna superiore Jota.

ARTICOLO	<b>41 LI J</b>	<b>41 LI J CE</b>
FINITURA	VITONE TRADIZIONALE	VITONE CERAMICO



Gruppo lavello monoforo con canna girevole.

ARTICOLO	<b>43 LI</b>	<b>43 LI CE</b>
FINITURA	VITONE TRADIZIONALE	VITONE CERAMICO



Monoforo lavello con canna antica.

ARTICOLO	<b>43 LI A</b>	<b>43 LI A CE</b>
FINITURA	VITONE TRADIZIONALE	VITONE CERAMICO



Gruppo lavello monoforo con canna Jota.

ARTICOLO	<b>43 LI J</b>	<b>43 LI J CE</b>
FINITURA	VITONE TRADIZIONALE	VITONE CERAMICO



Gruppo lavello a muro con canna superiore antica.

ARTICOLO	<b>41 LI A</b>	<b>41 LI A CE</b>
FINITURA	VITONE TRADIZIONALE	VITONE CERAMICO



LINEA MONO ACQUA



Rubinetto collo cigno 1/2, 3/4.

1/2		
ARTICOLO	15 LI	15 LI CE
FINITURA	VITONE TRADIZIONALE	VITONE CERAMICO

3/4		
ARTICOLO	15 LI 34	15 LI 34 CE
FINITURA	VITONE TRADIZIONALE	VITONE CERAMICO



Rubinetto incasso dritto 1/2, 3/4.

ARTICOLO	31 LI	31 LI CE
FINITURA	VITONE TRADIZIONALE	VITONE CERAMICO



Rubinetto con portagomma, 1/2".

ARTICOLO	52 LI	52 LI CE
FINITURA	VITONE TRADIZIONALE	VITONE CERAMICO



Rubinetto prolungato, 1/2".

ARTICOLO	51 LI	51 LI CE
FINITURA	VITONE TRADIZIONALE	VITONE CERAMICO



Rubinetto a snodo pesante, 1/2" con canna alta a "S" Ø 18 girevole, con rompigitto.

ARTICOLO	53 S LI	53 S LI CE
FINITURA	VITONE TRADIZIONALE	VITONE CERAMICO



Rubinetto a squadra per lavatrice, 1/2" x 3/4".

ARTICOLO	55 LI	55 LI CE
FINITURA	VITONE TRADIZIONALE	VITONE CERAMICO



Rubinetto a snodo pesante, 1/2" canna alta "J", Ø 18, con canna girevole e rompigitto.

ARTICOLO	53 J LI	53 J LI CE
FINITURA	VITONE TRADIZIONALE	VITONE CERAMICO



Rubinetto monoforo per lavello con canna alta a "J" e rompigitto.

ARTICOLO	54 LI	54 LI CE
FINITURA	VITONE TRADIZIONALE	VITONE CERAMICO



Rubinetto a snodo pesante, 1/2" canna Ø 18, con rompigitto.

ARTICOLO	53 LI	53 LI CE
FINITURA	VITONE TRADIZIONALE	VITONE CERAMICO



Rubinetto curvo con maniglia MINI Y, 1/2".

ARTICOLO	57 LI	57 LI CE
FINITURA	VITONE TRADIZIONALE	VITONE CERAMICO



Rubinetto curvo con uscita da 1/2" e uscita da bocca di erogazione, attacco 1/2" M.

ARTICOLO	251 LI	251 LI CE
FINITURA	VITONE TRADIZIONALE	VITONE CERAMICO



Rubinetto a snodo con attacco lavatrice e attacco da 1/2" con canna ad S girevole.

ARTICOLO	252 LI	252 LI CE
FINITURA	VITONE TRADIZIONALE	VITONE CERAMICO

# MUSA

## CARATTERISTICHE TECNICHE:

La serie è dotata di cartuccia a dischi ceramici Ø 40 mm, prodotta da S.T.S.R. – Studio Tecnico Sviluppo e Ricerche - [www.stsr.it](http://www.stsr.it).  
Finiture disponibili: cromo, cromo oro, bianco lucido.

CLASSICA

LIBERTY

MUSA

1000-2000





**SIMBOLOGIE:**



Con scarico e troppo pieno



Senza scarico



Proporzione perfetta.



Con Kit Doccia e flessibile lungo: 120, 150 o 200 cm



Doccetta Anticalcare



Lavello sottofinestra con canna girevole



Canna girevole



Canna alta girevole



Doccetta estraibile



Con getto a cascata.



Getto con massaggio intenso a risparmio idrico



Getto effetto pioggia



Getto ad ampia copertura effetto pioggia



Massaggio con getto vigoroso concentrato



Massaggio vigoroso ampia copertura effetto pioggia



Getto spray delicato ad ampia copertura con getto vigoroso all'esterno a risparmio idrico



Pioggia soft a risparmio idrico



Prodotto novità

**LAVABI E BIDET**



**M 10**  
Miscelatore monocomando per lavabo con scarico.



**M 11**  
Miscelatore monocomando per lavabo senza scarico.



**M 20**  
Miscelatore monocomando per bidet, con aeratore direzionabile, con scarico.



**M 21**  
Miscelatore monocomando per bidet, con aeratore direzionabile senza scarico.

VASCA



**M 02**  
Miscelatore monocomando per vasca, esterno, con doccia duplex, a 5 funzioni.

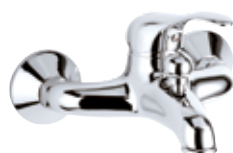

**M 05**  
Miscelatore monocomando per vasca, esterno, senza kit doccia.



**M 08 UK**  
Miscelatore monocomando per vasca, esterno, su colonnette, con doccia duplex a 5 funzioni.



**M 03**  
Miscelatore monocomando per lavabo/vasca con deviatore integrato, e doccia duplex, a 5 funzioni.



**M 04**  
Miscelatore monocomando lavabo/vasca con deviatore integrato senza kit doccia.



**M 49**  
Miscelatore lavabo/vasca con canna fusa lunga 30 cm e deviatore con kit doccia 5 funzioni.



**M 46**  
Miscelatore lavabo/vasca con canna fusa lunga 30 cm e deviatore senza kit doccia.



**M 07**  
Miscelatore monocomando bordo vasca con deviatore integrato nella bocca, bocca pesante fusa e doccetta estraibile con idromassaggio e anticalcare a 4 funzioni.



**M 07 UF**  
Miscelatore monocomando bordo vasca con deviatore integrato nel miscelatore, bocca pesante fusa con effetto a cascata e doccetta estraibile con idromassaggio e anticalcare a 4 funzioni.

## DOCCE



**310 321SC**

Saliscendi cromato con asta tonda e doccetta anticalcare a 5 funzioni.



**M 38**

Miscelatore monocomando esterno per doccia, con leva frontale e doccia duplex a 5 funzioni.



**M 39**

Miscelatore monocomando esterno per doccia, con doccia duplex 5 funzioni.



**M 33**

Miscelatore monocomando esterno per doccia con leva frontale.



**M 31**

Miscelatore monocomando esterno per doccia.

## INCASSI



**M 09**

Miscelatore monocomando incasso vasca/doccia con deviatore.



**M 30**

Miscelatore monocomando incasso doccia.

## BOX INCASSO



**RR BOX**

Box da incasso per miscelatore doccia con deviatore.

**NEW**



**M 30 KB**

Set miscelatore doccia da abbinare al box incasso.



**RR BOX**

Box da incasso per miscelatore doccia con deviatore.

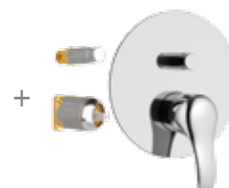

**M 09 KB**

Set miscelatore doccia con deviatore da abbinare al box incasso.



BOCCE



**91**  
Bocca incasso miscelatore vasca-doccia.



**91 D**  
Bocca incasso vasca-doccia, con deviatore integrato.



**91 UF 07**  
Bocca bordo vasca con getto a cascata.

CUCINA



**M 40**  
Miscelatore monocomando per lavello, con bocca girevole.



**M 47**  
Miscelatore monocomando per lavello, con doccia estraibile a getto variabile.



**M 42**  
Miscelatore monocomando per lavello, con bocca alta girevole.



**M 42 C**  
Miscelatore monocomando per lavello, con bocca girevole modello corto, tipo lusso.



**M 42 U**  
Miscelatore monocomando per lavello, con bocca alta a "U" girevole.



**M 43**  
Miscelatore monocomando per lavello a muro, con leva frontale e bocca alta girevole.



**M 43 C**  
Miscelatore monocomando per lavello a muro, con leva frontale e bocca girevole modello corto.



**M 42 R**  
Miscelatore monocomando monoforo 90° per lavello, con bocca alta girevole ed orientabile, tipo lusso, modello sottofinestra.



**M 41**  
Miscelatore monocomando per lavello a muro, con bocca girevole 20 cm.



**M 41 S**  
Miscelatore monocomando per lavello a muro, con bocca a "S" girevole 21 cm.



# 1000-2000

## CARATTERISTICHE TECNICHE:

La serie è normalmente dotata di vitoni tradizionali, a richiesta è disponibile anche con vitoni ceramici S.T.S.R. - [www.stsr.it](http://www.stsr.it).



CLASSICA

LIBERTY

MUSA











1000-2000



**SIMBOLOGIE:**

-   
 Con scarico e troppo pieno
-   
 Senza scarico
-   
 Proporzione perfetta.
-   
 Con Kit Doccia e flessibile lungo: 120, 150 o 200 cm
-   
 Colonna doccia girevole.
-   
 Canna girevole
-   
 Canna alta girevole
-   
 Doccetta estraibile
-   
 Massaggio vigoroso ampia copertura effetto pioggia
-   
 Ampio getto pioggia a risparmio idrico
-   
 Massaggio con getto vigoroso concentrato

LE TIPOLOGIE DI PREZZO SONO DIVISE PER GRUPPI COME DI SEGUITO RAPPRESENTATO:

SERIE 1000:						SERIE 2000:				
MANIGLIE Y		MANIGLIE EX			MANIGLIE CA			MANIGLIE MO		
										
Y	YG	Export (EX)	G	GT	Caprice (CA)	Asia (AS)	Vittoria (VI)	Moon (MO)	Egizia (EG)	Zeta (ZE)

**LAVABI**



**11 EX**  
Batteria lavabo con scarico automatico, 1"1/4.



**12 EX**  
Batteria lavabo senza scarico.



**13 EX**  
Monoforo lavabo con scarico automatico, 1"1/4.



**14 EX**  
Gruppo lavabo tipo a ponte, canna Ø18.



**14 C EX**  
Gruppo lavabo tipo a ponte, canna alta a "C".



**17 EX**  
Gruppo lavabo con interasse 160 mm e canna a jota Ø18.



**15 EX**  
Rubinetto collo cigno 1/2.

**BIDET**



**21 EX**  
Combinazione bidet con scarico automatico, 1"1/4.



**22 EX**  
Batteria bidet con doccia e scarico, 1"1/4.



**23 EX**  
Monoforo bidet con scarico automatico, 1"1/4.







**25 EX**  
Rubinetto bidet 1/2.



**31 EX**  
Rubinetto incasso diritto 1/2.



**32 EX**  
Rubinetto incasso a sfera removibile con maniglia, 1/2, 3/4.



Rubinetto incasso con cappuccio a 2 pezzi, 1/2, 3/4.



Rubinetto incasso a sfera con cappuccio a 2 pezzi, 1/2, 3/4.



Rubinetto incasso a sfera con maniglia a leva, 1/2, 3/4.

## VASCA



**01 EX**  
Gruppo vasca esterno con kit doccia.



**02 EX**  
Gruppo vasca esterno con kit doccia duplex.



**05 EX**  
Gruppo vasca esterno senza kit doccia.



**04 EX**  
Gruppo vasca esterno con doccia duplex, doppia forcella e canna lunga girevole 40 cm.



**04 S**  
Gruppo vasca esterno con doccia duplex e canna lunga girevole 40 cm e forcella singola.

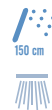





**01 S**  
Gruppo vasca esterno con doccia e forcella singola.



**02 S**  
Gruppo vasca esterno con doccia duplex e forcella singola.



**05 S**  
Gruppo vasca esterno senza kit doccia con forcella singola.



**07 EX**  
Gruppo vasca con deviatore e attacco superiore 3/4 M.



**08 EX**  
Gruppo vasca con colonna doccia 1/2x3/4 e soffione doccia standard.

DOCCIA



**329EX 351EX**  
Colonna doccia 1/2x3/4 e soffione doccia standard.



**38EX329 351EX**  
Miscelatore esterno doccia con attacco alto e colonna doccia 1/2x3/4 con soffione doccia standard.



**55EX329 351EX**  
Colonna doccia 1/2x3/4 con soffione doccia standard e rubinetto a squadra.



**38 EX**  
Gruppo esterno per doccia.



**39 EX**  
Gruppo esterno per doccia, con doccia duplex.  
150 cm

## CUCINA



**41 EX**  
Gruppo lavello con canna inferiore girevole a "S".



**41 S EX**  
Gruppo lavello con canna superiore.



**41 J EX**  
Gruppo lavello con canna alta girevole.



**41 L**  
Gruppo lavello a muro con canna inferiore, interasse 20 cm, lunghezza canna 18 cm.  
Y € 62,40



**41 LS**  
Gruppo lavello a muro con canna alta, interasse 20 cm, lunghezza canna 18 cm.  
Y € 62,40



**42 EX**  
Gruppo lavello con attacco lavatrice, con canna inferiore lunga 18 cm.



**43 EX**  
Monoforo lavello con canna girevole.



**43 C EX**  
Monoforo lavello con canna girevole, modello tipo corto.



**45 EX**  
Monoforo lavello con canna girevole.



**46 EX**  
Monoforo lavello con deviatore lavastoviglie.



**47 EX**  
Monoforo lavello con doccia estraibile.



**48 EX**  
Gruppo miscelatore per boiler con canna girevole e due cannucce in rame cromato, 1/2. Lunghezza canna 15,5 cm, interasse 15 cm.



LINEA MONO ACQUA



**51 EX**  
Rubinetto prolungato, 1/2.



**52 EX**  
Rubinetto con portagomma, 1/2.



**53 EX**  
Rubinetto a snodo pesante, 1/2 canna Ø 18 mm lunghezza 21 cm.



**53 S EX**  
Rubinetto a snodo pesante, 1/2 con canna alta Ø18 girevole lunga 21 cm, con rompigitto.



**53 J EX**  
Rubinetto a snodo pesante, 1/2 con canna alta a "J" Ø 18 girevole, con rompigitto.



**54 EX**  
Rubinetto monoforo per lavello con canna alta a "J" e rompigitto.



**55 EX**  
Rubinetto a squadra per lavatrice, 1/2x3/4.



**57 EX**  
Rubinetto curvo con maniglia MINI Y.



**58 EX**  
Rubinetto curvo con portagomma maniglia MINI Y, 1/2.



**250 EX**  
Rubinetto a due maniglie per attacco lavatrice, 1/2" x 3/4".



**250 1/2x3/4 EX**  
Rubinetto a due maniglie per attacco lavatrice, 1/2" x 3/4" x 3/4".



**252 EX**  
Rubinetto a snodo con attacco lavatrice e bocca girevole lunga 17,5 cm, 1/2".



**251 EX**  
Rubinetto curvo con uscita da 1/2" e uscita da bocca di erogazione, attacco 1/2" M.

**71 Y**   **71 YG**

€ 4,80

**71 EX**   **71 G**   **71 GT**

€ 4,80

**71 CA**   **71 AS**   **71 VI**

€ 6,90

**71 MO**   **71 EG**   **71 ZE**

€ 10,60

Per ordinare solo la maniglia mettere il codice 71 + il codice della maniglia (es. 71 AS)

LIBERTY

MUSA

1000-2000

# SENSOR COLOR

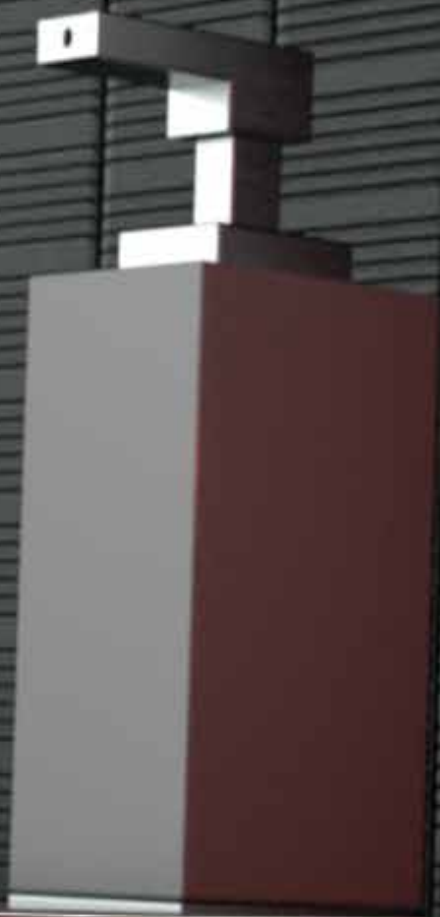

SENSOR COLOR

SENSOR

TEMPOR TOUCH

TEMPOR

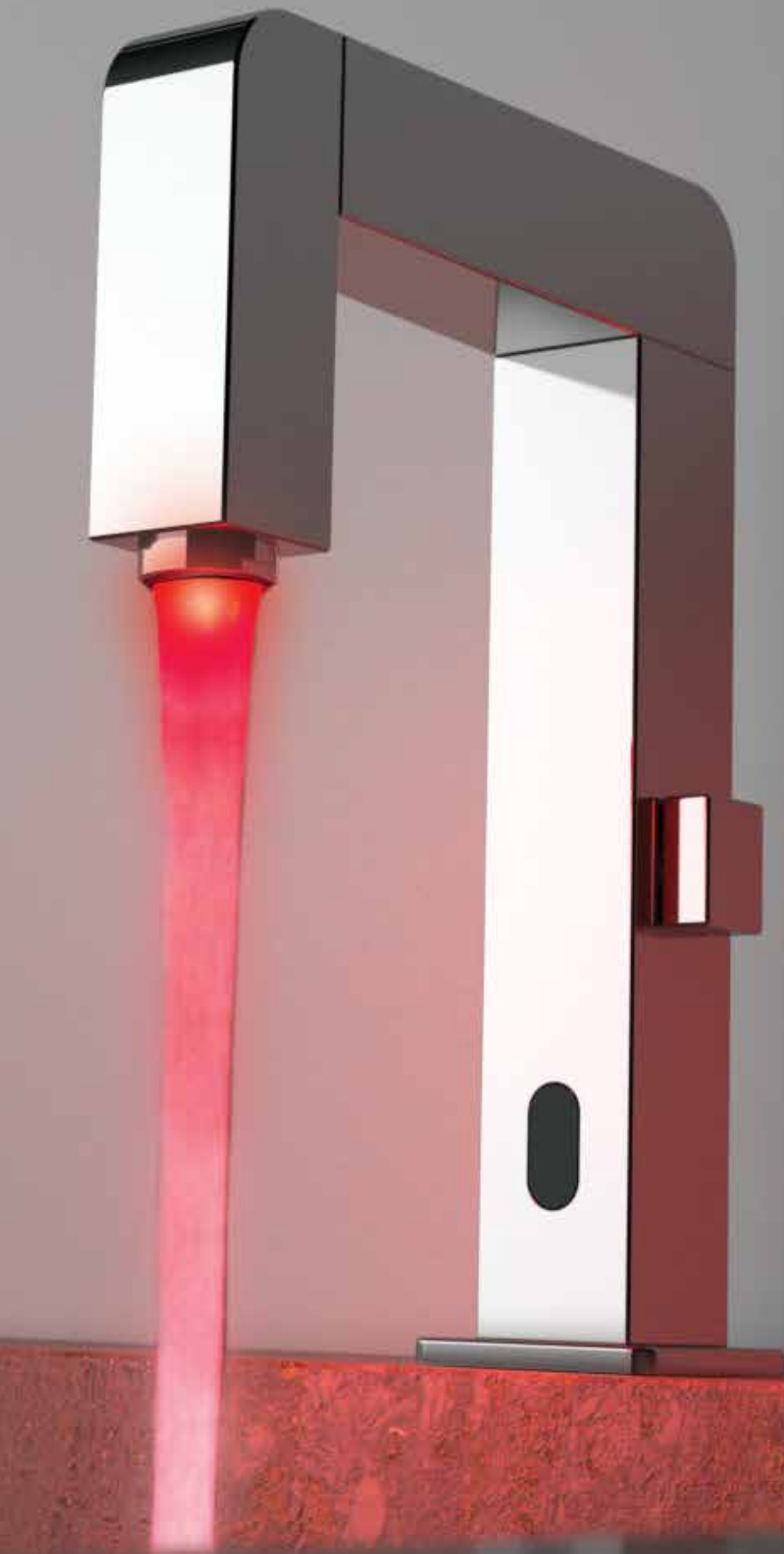



#### SIMBOLOGIE:



Proporzione perfetta.



Con Luce Led



Con Batterie Alcaline Incluse



Con Batterie al Litio Incluse



Con Rubinetto Filtro incluso



Prodotto novità



Disponibile a richiesta con aeratore antivandalico e chiave, vedi articolo 83 AVC



Tutti i prodotti sono soggetti a modifiche senza alcun preavviso. Le informazioni e i materiali contenuti in queste pagine sono soggetti a modifiche.



La tecnologia COLOR LED LIGHT è disponibile in quattro varianti denominate A, B, C, D. Per evidenziare la Vostra scelta, aggiungere la lettera corrispondente a fine codice articolo.

*L'utilizzo della rubinetteria a sensore agevola il risparmio idrico negli ambienti pubblici, garantendo sia un alto livello di igiene che un controllo dei consumi estremamente elevato.*

*Regolare l'erogazione dell'acqua tramite la tecnologia a sensore assicura infatti la riduzione degli sprechi, limitando i tempi di utilizzo alla sola necessità effettiva.*

*L'elettronica utilizzata è prodotta all'interno del Gruppo Remer dall'azienda italiana S.T.S.R. (S.T.S.R. - Studio Tecnico Sviluppo e Ricerche - Lacchiarella - Milano) e tutti i prodotti risultano conformi agli standard della certificazione CE.*

*Una tecnologia di grande sicurezza e precisione, non influenzabile da sorgenti elettromagnetiche o riflessioni ottiche, che attiva l'erogazione*

*al riconoscimento di una presenza tramite segnali infrarossi.*

*I sensori sono dotati di una funzionalità anti-vandalo che blocca automaticamente l'erogazione dell'acqua al superamento di un periodo di tempo prefissato.*

*Inoltre, nei momenti di scarso utilizzo, la reattività del sensore si imposta su una modalità di funzionamento a basso consumo che riduce l'utilizzo energetico delle batterie.*

*Per evitare che le impurità dell'acqua entrino in contatto con la meccanica e per preservare la qualità del prodotto nel tempo, tutta la rubinetteria elettronica prevede l'installazione di rubinetti di arresto con filtri per la pulizia dell'acqua in ingresso in dotazione ai prodotti.*





## SENSOR COLOR



### SE 28R

Rubinetto lavabo ad incasso a sensore, con luce led, monoacqua o premiscelata.



#### DATI TECNICI:

- Pressione di lavoro: 1 --> 5 Bar
- Temperatura acqua: 80° C max
- Diametro di entrata: Ø G 1/2 M
- Raggio d'azione di riconoscimento: 10 cm circa, predisposto
- Alimentazione elettrica: 4 batterie litio da 1,5 V tipo AA
- Portabatterie adesivizzabile IPX5.
- 2 modalità di funzionamento selezionabili (basso consumo/alta reattività).
- Omologazione CE.
- Connessioni IP67.



### SE 18R

Miscelatore elettronico lavabo ad azionamento a sensore, con luce led e regolazione acqua caldo/freddo con rubinetto sottolavabo con filtro incluso.



#### DATI TECNICI:

- Pressione di lavoro: 1 --> 5 Bar
- Temperatura acqua: 80° C max
- Diametro di entrata: Ø G 1/2 M
- Raggio d'azione di riconoscimento: 10 cm circa, predisposto
- Alimentazione elettrica: 4 batterie litio da 1,5 V tipo AA
- Portabatterie adesivizzabile IPX5.
- 2 modalità di funzionamento selezionabili (basso consumo/alta reattività).
- Omologazione CE.
- Connessioni IP67.

A modern, minimalist bathroom sink with a white, rectangular basin set into a white countertop. The sink is equipped with a sleek, chrome-finished sensor faucet. To the right of the sink, a matching chrome soap dispenser with a white cylindrical body stands on the countertop. The background wall is covered in light-colored, rectangular tiles with a subtle texture. A dark grey horizontal bar is overlaid across the middle of the image, containing the word "SENSOR" in white, bold, uppercase letters.

**SENSOR**

# SENSOR & TEMPOR

SENSOR COLOR

SENSOR

TEMPOR TOUCH

TEMPOR







#### SIMBOLOGIE:

 Proporzione perfetta.

 Con Luce Led

 Con Batterie Alcaline Incluse

 Con Batterie al Litio Incluse

 Con Rubinetto Filtro incluso

 Prodotto novità

 Disponibile a richiesta con aeratore antivandalico e chiave, vedi articolo 83 AVC



Tutti i prodotti sono soggetti a modifiche senza alcun preavviso. Le informazioni e i materiali contenuti in queste pagine sono soggetti a modifiche.



#### SE 28

Rubinetto lavabo ad incasso a sensore, monoacqua o premiscelata.



#### SE 28 Q

Rubinetto lavabo ad incasso a sensore, monoacqua o premiscelata.



#### SE 18

Miscelatore elettronico lavabo ad azionamento a sensore, con regolazione acqua caldo/freddo, rubinetti sottolavabo con filtri inclusi.



#### SE 25

Miscelatore elettronico lavabo ad azionamento a sensore, per acqua premiscelata, dotato di rubinetti sottolavabo con filtro.

#### DATI TECNICI:

- Pressione di lavoro: 1 --> 5 Bar
- Temperatura acqua: 80° C max
- Diametro di entrata: Ø G 1/2 M
- Raggio d'azione di riconoscimento: 10 cm, predisposto
- Alimentazione elettrica: 4 batterie litio da 1,5 V tipo AA
- Portabatterie adesivizzabile IPX5.
- 2 modalità di funzionamento selezionabili (basso consumo/alta reattività).
- Omologazione CE.
- Connessioni IP67.

SENSOR COLOR

SENSOR

TEMPOR TOUCH

TEMPOR



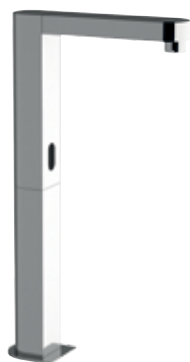

### SE 17 L

Rubinetto elettronico alto per lavabo con azionamento a sensore, per acqua premiscelata, dotato di due rubinetti sottolavabo con filtro.

### SE 16 L

Rubinetto elettronico alto mono-acqua per lavabo con azionamento a sensore, dotato di rubinetto sottolavabo con filtro.



### SE 17

Rubinetto elettronico per lavabo con azionamento a sensore, per acqua premiscelata, dotato di due rubinetti sottolavabo con filtro.

### SE 16

Rubinetto elettronico mono-acqua per lavabo con azionamento a sensore, dotato di rubinetto sottolavabo con filtro.

#### DATI TECNICI:

- Pressione di lavoro: 1 --> 5 Bar
- Temperatura acqua: 80° C max
- Diametro di entrata: Ø G 1/2 M
- Raggio d'azione di riconoscimento: 10 cm, circa predisposto
- Alimentazione elettrica: 4 batterie litio da 1,5 V tipo AA
- Portabatterie adesivizzabile IPX5.
- 2 modalità di funzionamento selezionabili (basso consumo/alta reattività).
- Omologazione CE.
- Connessioni IP67.







## SE 15

Rubinetto elettronico con azionamento a sensore ad acqua singola con rubinetto sottolavabo con filtro incluso.



## SE 15 B

Rubinetto elettronico ad azionamento a sensore ad acqua singola con basetta con rubinetto sottolavabo con filtro incluso.



## SE 14

Miscelatore elettronico ad azionamento a sensore, con regolazione acqua caldo/freddo con rubinetto sottolavabo con filtro incluso.



## SE 14 B

Miscelatore elettronico ad azionamento a sensore con regolazione acqua caldo/freddo con basetta con rubinetto sottolavabo con filtro incluso.

### DATI TECNICI:

- Pressione di lavoro: 1 --> 5 Bar
- Temperatura acqua: 80° C max
- Diametro di entrata: Ø G 1/2 M
- Raggio d'azione di riconoscimento: 10 cm circa, predisposto
- Alimentazione elettrica: 4 batterie litio da 1,5 V tipo AA
- Portabatterie adesivizzabile IPX5.
- 2 modalità di funzionamento selezionabili (basso consumo/alta reattività).
- Omologazione CE.
- Connessioni IP67.

SENSOR COLOR

SENSOR

TEMPOR TOUCH

TEMPOR



## SE 30

Rubinetto elettronico a incasso per orinatoio.



## SE 33

Rubinetto elettronico esterno per orinatoio.



### DATI TECNICI:

- Pressione di lavoro: 1 – 6 Bar
- Diametro di entrata: G1/2
- Azionamento: elettrovalvola integrata
- Raggio d'azione di riconoscimento: 30 – 60 cm, regolabile.
- Alimentazione elettrica: DC 4.5V tre batterie alcaline "AAA" da 1.5V
- Installazione: montaggio ad incasso.

### DATI TECNICI:

- Pressione di lavoro: 1 – 6 Bar
- Diametro di entrata: G1/2
- Raggio d'azione di riconoscimento: 35 cm, predisposto.
- Alimentazione elettrica: DC 6V quattro batterie alcaline "AAA" da 1.5V
- Modalità di installazione: esterno



## SEPW KIT

Kit composto da:

connettore per alimentazione elettrica dei dispositivi elettronici, con commutazione automatica a batteria in caso di mancanza energia elettrica ed alimentatore a 6V, in scatola (da utilizzare con batterie alcaline).



# TEMPOR TOUCH

# SENSOR & TEMPOR

SENSOR COLOR

SENSOR

TEMPOR TOUCH

TEMPOR





**SIMBOLOGIE:**



Disponibile a richiesta con aeratore antivandalico e chiave, vedi articolo 83 AVC

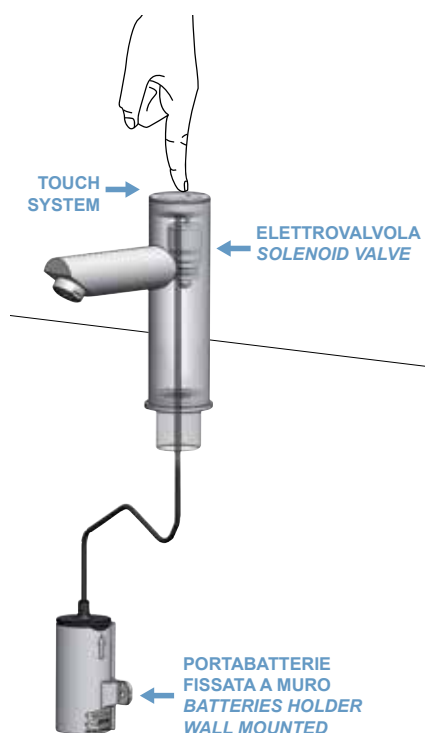

La temporizzazione elettronica dei modelli TEMPOR TOUCH si avvale della tecnologia di attivazione PIEZO.

L'erogazione dell'acqua si attiva tramite la pressione di un pulsante piezoelettrico e si interrompe automaticamente dopo un periodo o su richiesta con una successiva pressione del tasto.

La versione a due tempi opera nella stessa maniera permettendo all'utente la selezione della temporizzazione prima della apertura della valvola attraverso una o due pressioni del tasto con relativo feedback ottico (due diversi colori di luce led anziché uno della versione mono tempo).

La tecnologia impiegata da questo prodotto si contraddistingue dalla capacità di elevare il livello di precisione e sicurezza, e di assicurare le prestazioni desiderate anche su installazioni multiple e/o in linea.

La versione ad un solo tempo è suggerita in luoghi in cui gli utenti cambiano costantemente (aeroporti, scuole, bagni pubblici etc) mentre la versione a due tempi è suggerita in luoghi in cui gli utenti sono comunemente un gruppo costante (uffici, installazioni private, laboratori e studi medici etc).

Versione 1 tempo: preimpostato di fabbrica a 10 secondi circa (erogazione istantanea a fronte della pressione del tasto)

Versione a 2 tempi: preimpostata di fabbrica a circa 10 secondi (tempo 1) e circa 20 secondi (tempo 2). Un piccolo ritardo nell'erogazione di circa 1 secondo e mezzo consente all'utente di effettuare la selezione necessaria.

TEMPOR TOUCH



TTE 19

Rubinetto a temporizzazione elettronica con attivazione tramite pulsante ad azionamento piezoelettrico alimentato a batteria, minimale quadrato, in ottone cromato, tempo d'apertura circa 10 secondi, con rubinetto sottolavabo con filtro incluso.

TTE 219

Rubinetto a temporizzazione elettronica con attivazione tramite pulsante ad azionamento piezoelettrico alimentato a batteria, minimale quadrato, in ottone cromato, a due tempi d'apertura: primo tempo circa 10 secondi, secondo tempo circa 20 secondi, con rubinetto sottolavabo con filtro incluso.



TTE 18

Rubinetto a temporizzazione elettronica con attivazione tramite pulsante ad azionamento piezoelettrico alimentato a batteria, minimale tondo, in ottone cromato, tempo d'apertura circa 10 secondi, con rubinetto sottolavabo con filtro incluso.

TTE 218

Rubinetto a temporizzazione elettronica con attivazione tramite pulsante ad azionamento piezoelettrico alimentato a batteria, minimale tondo, in ottone cromato, a due tempi d'apertura: primo tempo 10 secondi, secondo tempo 20 secondi, con rubinetto sottolavabo con filtro incluso.



TTEQ 40 DW

Miscelatore lavello quadrato a tre vie di ingresso con bocca girevole, con selezione acqua potabile tramite pulsante ad azionamento piezoelettrico alimentato a batteria, con 2 aeratori in uscita e canali indipendenti.



TTEN 40 DW

Miscelatore lavello Minimale a tre vie di ingresso con bocca girevole, con selezione acqua potabile tramite pulsante ad azionamento piezoelettrico alimentato a batteria, con 2 aeratori in uscita e canali indipendenti.



# TEMPOR

# SENSOR & TEMPOR

SENSOR COLOR

SENSOR

TEMPOR TOUCH

TEMPOR



## LAVABI



**TE 15**

Rubinetto temporizzato a collo cigno, 1/2", in ottone cromato, tempo d'apertura 6-8 secondi.



**TE 16**

Rubinetto temporizzato a collo cigno, 1/2", in ottone cromato, tempo d'apertura 6-8 secondi.



**TE 18**

Rubinetto temporizzato a collo cigno, Minimal, 1/2", in ottone cromato, tempo d'apertura 6-8 secondi.



**TE 18 M**

Rubinetto miscelatore temporizzato a collo cigno con maniglia per la selezione dell'acqua calda/fredda, serie minimal, 1/2", in ottone cromato, tempo di apertura 6-8 secondi.



**TE 19 M**

Rubinetto miscelatore temporizzato con miscelazione tramite vitone, con collo a cigno e maniglia per la selezione dell'acqua calda/fredda, serie minimal, 1/2", in ottone cromato, tempo di apertura 6-8 secondi.



**TE 19**

Rubinetto temporizzato serie SQ a collo cigno, 1/2", in ottone cromato, tempo d'apertura 6-8 secondi.



**TE 20**

Rubinetto temporizzato a collo cigno, 1/2", in ottone cromato, tempo d'apertura 6-8 secondi.



**TE 22**

Rubinetto temporizzato 1/2", linea ovale in ottone cromato tempo d'apertura 6-8 secondi.



**TE 225**

Rubinetto frontale temporizzato, 1/2", in ottone cromato, tempo d'apertura 6-8 secondi.



**TE 53**

Rubinetto frontale temporizzato, con canna "S", 1/2", in ottone cromato, tempo d'apertura 6-8 secondi.



**TE 42 S**

Rubinetto superiore temporizzato, con canna "U", 1/2", in ottone cromato, tempo d'apertura 6-8 secondi.



**TE 42**

Rubinetto superiore temporizzato, con canna "J", 1/2", in ottone cromato, tempo d'apertura 6-8 secondi.



**TE VI**

Cartuccia di ricambio per rubinetti temporizzati art. TE 15, TE 16, TE 53, TE 225, TE 855.

## TOILET



**TE 171**

Flussometro temporizzato a incasso, a pulsante, per wc, 3/4, 1", tempo d'apertura 6-8 secondi.



**TE 171Q**

Flussometro temporizzato a incasso quadrato a pulsante per wc, 3/4, 1", tempo d'apertura 6-8 secondi.



**TE 170**

Flussometro temporizzato a pulsante esterno per WC, in ottone cromato, tempo d'apertura 5-6 secondi, misure: 3/4, 1".

## SENSOR & TEMPOR

### 332 TEL

Set composto da: doccia a pulsante, flessibile conico cm 120, rubinetto temporizzato 1/2" in ottone cromato, tempo d'apertura 6-8 secondi.



### TE 855

Rubinetto temporizzato a pulsante per orinatoio, 1/2", in ottone cromato, completo di rosoni, di due tubetti Ø mm 14 e guarnizione. Tempo d'apertura 6-8 secondi.



### 170 TU

Tubo a "L" per flussometro esterno, in ottone cromato, Ø 25, 30.



### RB 100 TE

Set composto da: idroscopino a pulsante in ottone cromato, flessibile conico cm 120, rubinetto temporizzato 1/2" in ottone cromato, tempo d'apertura 6-8 secondi.



### TE 856

Rubinetto temporizzato a pulsante per orinatoio, serie SQ, 1/2", in ottone cromato, completo di rosoni, di due tubetti Ø mm 14 e guarnizione. Tempo d'apertura 6-8 secondi.



### 856

Spartiacque per orinatoio, attacco Ø 15, con tubo Ø 15 mm.



## DOCCIA

### 351 AVS

Soffione doccia antivandalo ed antimpiccagione con getto fisso.



NEW

### 351 AV

Soffione doccia antivandalo ed antimpiccagione con getto regolabile.



NEW

### TE 31

Rubinetto temporizzato a pulsante per doccia esterno, 1/2"x1/2", in ottone cromato, tempo d'apertura 18-20 secondi.



### TE 30

Rubinetto per doccia incasso temporizzato, 1/2", tempo d'apertura 18-20 secondi.

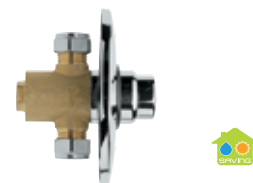

### TE VI 30

Cartuccia di ricambio per rubinetti temporizzati art. TE 30 - TE 31.



### TE 53 329EX 351

Rubinetto frontale temporizzato, colonna doccia 1/2" x 3/4" e soffione doccia standard, tempo d'apertura 25 secondi.



CR € 73,10

### TE 30Q

Rubinetto per doccia incasso temporizzato quadrato, 1/2", in ottone cromato, tempo d'apertura 18-20 secondi.

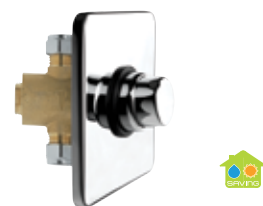

SENSOR COLOR

SENSOR

TEMPOR TOUCH

TEMPOR

# CONTRACT

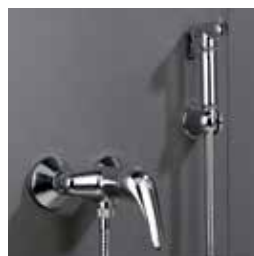
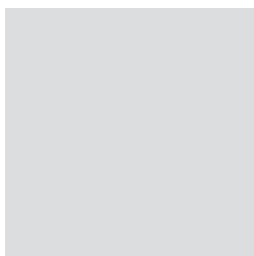
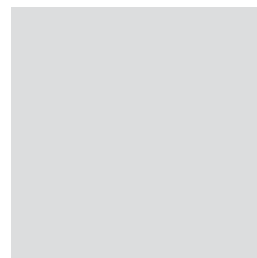
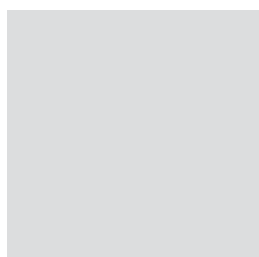
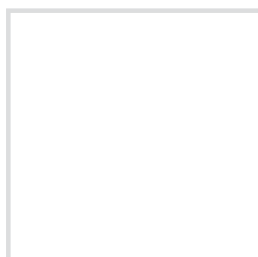

**PROJECT**



**TEN**



**GIGA FOUR**



**KI**



PROJECT

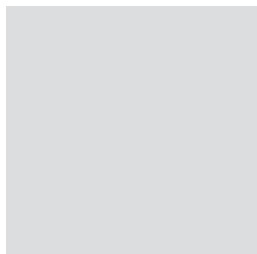

TEN

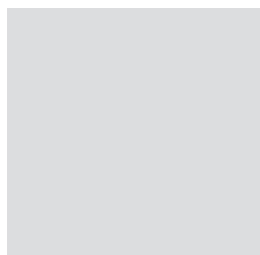

GIGA FOUR

KISS

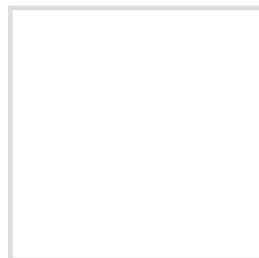

REMIX

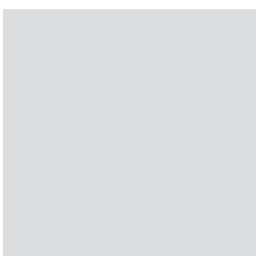

35

100



ACCESSORI PER RUBINETTERIA

SS

REMIX

35

100



# PROJECT

## CARATTERISTICHE TECNICHE:

La serie è dotata di cartuccia a dischi ceramici Ø 40 mm, prodotta da S.T.S.R. – Studio Tecnico Sviluppo e Ricerche - [www.stsr.it](http://www.stsr.it).  
Finiture disponibili: cromo, cromo oro.

### SIMBOLOGIE:



Con scarico



Senza scarico



Proporzione perfetta.



Con Kit Doccia e flessibile lungo: 120, 150 o 200 cm



Doccetta Anticalcare



Lavello sottofinestra con canna girevole



Canna girevole



Canna alta girevole



Doccetta estraibile



Getto soft aerato misciato ad un getto vigoroso a risparmio idrico



Con getto a cascata.



Getto effetto pioggia



Getto con massaggio intenso a risparmio idrico



Getto ad ampia copertura effetto pioggia



Prodotto novità

## LAVABI E BIDET



**P 10**

Miscelatore monocomando per lavabo con scarico.



**P 11**

Miscelatore monocomando per lavabo senza scarico.



**P 20**

Miscelatore monocomando per bidet, con aeratore direzionabile e scarico.



**P 21**

Miscelatore monocomando per bidet, con aeratore direzionabile senza scarico.

VASCA



**P 02**  
Miscelatore monocomando per vasca, esterno, con doccia duplex.



**P 05**  
Miscelatore monocomando per vasca, esterno, senza kit doccia.



**P 07**  
Miscelatore monocomando bordo vasca con deviatore integrato nella bocca, bocca pesante fusa e doccetta estraibile con idromassaggio e anticalcare a 4 funzioni.

PROJECT

TEN

GIGA FOUR

KISS

REMIX

35

100

ACCESSORI PER RUBINETTERIA



**P 03**  
Miscelatore monoforo lavabo/vasca con deviatore integrato e kit doccia.



**P 04**  
Miscelatore monoforo lavabo/vasca con deviatore integrato senza kit doccia.



**P 07 UF**  
Miscelatore monocomando bordo vasca con deviatore integrato nel miscelatore, bocca pesante fusa con effetto a cascata e doccetta estraibile con idromassaggio e anticalcare a 4 funzioni.



**P 46**  
Miscelatore lavabo/vasca con canna fusa lunga 30 cm e deviatore senza kit doccia.



**P 49**  
Miscelatore lavabo/vasca con canna fusa lunga 30 cm e deviatore con kit doccia.

BOCCE



**91**  
Bocca incasso per miscelatore vasca-doccia.



**91 D**  
Bocca incasso vasca-doccia, con deviatore integrato.



**91 UF 07**  
Bocca bordo vasca con getto a cascata.



## DOCCE



**311D 312**

Saliscendi cromato con asta tonda e doccetta anticalcare.



**P 33**

Miscelatore monocomando esterno doccia con leva frontale.



**P 31**

Miscelatore monocomando esterno doccia.



**P 38**

Miscelatore monocomando esterno doccia, con doccia duplex e leva frontale.



**P 39**

Miscelatore monocomando esterno doccia, con doccia duplex.



## INCASSI DOCCIA



**P 09**

Miscelatore monocomando incasso vasca/doccia con deviatore.



**P 30**

Miscelatore monocomando incasso doccia.

## BOX INCASSO



**RR BOX**

Box da incasso per miscelatore doccia con deviatore.

**NEW**

+



**P 30 KB**

Set miscelatore doccia da abbinare al box incasso.



**RR BOX**

Box da incasso per miscelatore doccia con deviatore.

+



**P 09 KB**

Set miscelatore doccia con deviatore da abbinare al box incasso.

CUCINA

PROJECT

TEN

GIGA FOUR

KISS

REMIX

35

100

ACCESSORI PER RUBINETTERIA



**P 40**  
Miscelatore monocomando per lavello, con bocca girevole.



**P 47**  
Miscelatore monocomando per lavello, con doccia estraibile a getto variabile.



**P 42 R**  
Miscelatore monocomando monoforo 90° per lavello, con bocca alta girevole ed orientabile, tipo lusso, modello sottofinestra.



**P 42**  
Miscelatore monocomando per lavello, con bocca alta a "C" girevole, tipo lusso.



**P 42 C**  
Miscelatore monocomando per lavello, con bocca a "C" girevole, tipo lusso, modello corto.



**P 42 U**  
Miscelatore monocomando per lavello, con bocca alta a "U" girevole.



**P 43**  
Miscelatore monocomando per lavello a muro, con leva frontale e bocca alta girevole.



**P 43 C**  
Miscelatore monocomando per lavello a muro, con leva frontale e bocca girevole, modello corto.



**P 41**  
Miscelatore monocomando per lavello a muro, con bocca girevole lunghezza 20 cm.



**P 41 S**  
Miscelatore monocomando per lavello a muro, con bocca a "S" girevole, lunghezza 21 cm.



# TEN

## CARATTERISTICHE TECNICHE:

La serie è dotata di cartuccia a dischi ceramici Ø 40 mm, prodotta da S.T.S.R. – Studio Tecnico Sviluppo e Ricerche - [www.stsr.it](http://www.stsr.it).  
Finiture disponibili: cromo, cromo oro.

### SIMBOLOGIE:



Con scarico



Senza scarico



Proporzione perfetta.



Con Kit Doccia e flessibile lungo: 120, 150 o 200 cm



Doccetta Anticalcare



Lavello sottofinestra con canna girevole



Canna girevole



Canna alta girevole



Doccetta estraibile



Getto soft aerato misciato ad un getto vigoroso a risparmio idrico



Con getto a cascata.



Getto effetto pioggia



Getto con massaggio intenso a risparmio idrico



Getto ad ampia copertura effetto pioggia



Prodotto novità

### MANIGLIE:

T 10



T 10 2



T 10 3



T 10 4



## LAVABI E BIDET



T 10

Miscelatore monocomando lavabo con scarico.



T 11

Miscelatore monocomando lavabo senza scarico.



T 20

Miscelatore monocomando per bidet, con aeratore direzionabile e scarico.



T 21

Miscelatore monocomando per bidet, con aeratore direzionabile, senza scarico.



VASCA



**T 02**  
Miscelatore monocomando per vasca, esterno, con doccia duplex.



**T 05**  
Miscelatore monocomando per vasca, esterno, senza kit doccia.



**T 07**  
Miscelatore monocomando bordo vasca con deviatore integrato nella bocca, bocca pesante fusa e doccetta estraibile con idromassaggio e anticalcare a 4 funzioni.



**T 03**  
Miscelatore monoforo lavabo/vasca con deviatore integrato e kit doccia.



**T 04**  
Miscelatore monoforo lavabo/vasca con deviatore integrato senza kit doccia.



**T 07 UF**  
Miscelatore monocomando bordo vasca con deviatore integrato nel miscelatore, bocca pesante fusa con effetto a cascata e doccetta estraibile con idromassaggio e anticalcare a 4 funzioni.



**T 46**  
Miscelatore lavabo/vasca con canna fusa lunga 30 cm e deviatore senza kit doccia.



**T 49**  
Miscelatore lavabo/vasca con canna fusa lunga 30 cm e deviatore con kit doccia.

BOCCE



**91**  
Bocca incasso miscelatore vasca-doccia.



**91 D**  
Bocca incasso vasca-doccia, con deviatore integrato.



**91 UF 07**  
Bocca bordo vasca con getto a cascata.

PROJECT

TEN

GIGA FOUR

KISS

REMIX

35

100

ACCESSORI PER RUBINETTERIA

## DOCCE



**T 31**  
Miscelatore monocomando esterno per doccia.



**T 33**  
Miscelatore monocomando esterno per doccia con leva frontale.



**311D 312**  
Saliscendi cromato con asta tonda e doccetta anticalcare.



**T 39**  
Miscelatore monocomando esterno per doccia, con doccia duplex.



**T 38**  
Miscelatore monocomando esterno per doccia, con doccia duplex e leva frontale.



## INCASSI



**T 09**  
Miscelatore monocomando incasso vasca/doccia con deviatore.



**T 30**  
Miscelatore monocomando incasso doccia.

## BOX INCASSO



**RR BOX**  
Box da incasso per miscelatore doccia con deviatore.

**NEW**

+



**T 30 KB**  
Set miscelatore doccia da abbinare al box incasso.



**RR BOX**  
Box da incasso per miscelatore doccia con deviatore.

+



**T 09 KB**  
Set miscelatore doccia con deviatore da abbinare al box incasso.

CUCINA

PROJECT

TEN

GIGA FOUR

KISS

REMIX

35

100

ACCESSORI PER  
RUBINETTERIA



**T 40**  
Miscelatore monocomando per lavello, con bocca girevole.



**T 47**  
Miscelatore monocomando per lavello, con doccia estraibile a getto variabile.



**T 42 R**  
Miscelatore monocomando monoforo 90° per lavello, con bocca alta girevole ed orientabile, tipo lusso, modello sottofinestra.



**T 42**  
Miscelatore monocomando per lavello, con bocca alta girevole, tipo lusso.



**T 42 C**  
Miscelatore monocomando per lavello, con bocca girevole, modello corto, tipo lusso.



**T 42 U**  
Miscelatore monocomando per lavello, con bocca alta a "U" girevole.



**T 41**  
Miscelatore monocomando per lavello a muro, con bocca girevole lunghezza 20 cm.



**T 41 S**  
Miscelatore monocomando per lavello a muro, con bocca a "S" girevole, lunghezza 21 cm.



**T 43**  
Miscelatore monocomando per lavello a muro, con leva frontale e bocca alta girevole.



**T 43 C**  
Miscelatore monocomando per lavello a muro, con leva frontale e bocca girevole modello corto.



# GIGA FOUR

## CARATTERISTICHE TECNICHE:

La serie è dotata di cartuccia a dischi ceramici Ø 40 mm, prodotta da S.T.S.R. – Studio Tecnico Sviluppo e Ricerche - [www.stsr.it](http://www.stsr.it).  
Finiture disponibili: cromo, cromo oro.

### SIMBOLOGIE:

 Con scarico e troppo pieno	 Senza scarico	 Proporzione perfetta.	 Con Kit Doccia e flessibile lungo: 120, 150 o 200 cm	 Doccetta Anticalcare	 Lavello sottofinestra con canna girevole	 Canna girevole	 Canna alta girevole
 Doccetta estraibile	 Con getto a cascata.	 Getto con massaggio intenso a risparmio idrico	 Getto effetto pioggia	 Getto ad ampia copertura effetto pioggia	 Getto soft aerato misciato ad un getto vigoroso a risparmio idrico	 Prodotto novità	

### MANIGLIE:



## LAVABI E BIDET



### G 10 4

Miscelatore monocomando per lavabo con scarico.



### G 11 4

Miscelatore monocomando per lavabo senza scarico.



**G 20 4**  
Miscelatore monocomando per bidet con scarico.



**G 21 4**  
Miscelatore monocomando per bidet senza scarico.



**G 22 4**  
Miscelatore monocomando bidet con deviatore per bocca e doccetta, senza scarico.

VASCA



**G 02 4**  
Miscelatore monocomando per vasca, esterno, con doccia duplex.



**G 05 4**  
Miscelatore monocomando per vasca, esterno, senza kit doccia.



**G 07 4**  
Miscelatore monocomando bordo vasca serie con deviatore integrato nella bocca, bocca pesante fusa e doccetta estraibile con idromassaggio e anticalcare a 4 funzioni.



**G 03 4**  
Miscelatore monoforo lavabo/vasca con deviatore integrato e kit doccia.



**G 49 4**  
Miscelatore lavabo/vasca con canna fusa lunga 30 cm e deviatore con kit doccia.



**G 07 4 UF**  
Miscelatore monocomando bordo vasca con deviatore integrato nel miscelatore, bocca pesante fusa con effetto a cascata e doccetta estraibile con idromassaggio e anticalcare a 4 funzioni.



**G 04 4**  
Miscelatore monoforo lavabo/vasca con deviatore integrato senza kit doccia.



**G 46 4**  
Miscelatore lavabo/vasca con canna fusa lunga 30 cm e deviatore senza kit doccia.

## DOCCE



**311F 312**

Saliscendi cromato con asta tonda e doccetta anticalcare.

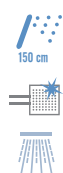

**G 39 4**

Miscelatore monocomando esterno per doccia, con doccia duplex.



**G 38 4**

Miscelatore monocomando esterno per doccia, con doccia duplex e leva frontale.



**G 31 4**

Miscelatore monocomando esterno per doccia, senza kit doccia.



**G 33 4**

Miscelatore monocomando esterno per doccia con leva frontale senza kit doccia.

## INCASSI



**G 09 4**

Miscelatore monocomando incasso vasca/doccia con deviatore.



**G 30 4**

Miscelatore monocomando incasso doccia.

## BOX INCASSO



**RR BOX**

Box da incasso per miscelatore doccia con deviatore.

**NEW**

+



**G 30 4 KB**

Set miscelatore doccia da abbinare al box incasso.



**RR BOX**

Box da incasso per miscelatore doccia con deviatore.

+



**G 09 4 KB**

Set miscelatore doccia con deviatore da abbinare al box incasso.



BOCCE



**91**  
Bocca incasso miscelatore vasca-doccia.



**91 D**  
Bocca incasso vasca-doccia, con deviatore integrato.



**91 UF 07**  
Bocca bordo vasca con getto a cascata.

PROJECT

TEN

CUCINA



**G 40 4**  
Miscelatore monocomando per lavello, con bocca girevole.



**G 47 4**  
Miscelatore monocomando per lavello, con doccia estraibile a getto variabile.



**G 42 4R**  
Miscelatore monocomando monoforo 90° per lavello, con bocca alta girevole ed orientabile, tipo lusso, modello sottofinestra.

GIGA FOUR

KISS



**G 42 4**  
Miscelatore monocomando per lavello, con bocca alta girevole, tipo lusso.



**G 42 4C**  
Miscelatore monocomando per lavello, con bocca girevole modello corto, tipo lusso.



**G 42 4U**  
Miscelatore monocomando per lavello, con bocca alta a "U" girevole.



**G 43 4**  
Miscelatore monocomando per lavello a muro, con leva frontale e bocca alta girevole.

REMIX

35



**G 43 4C**  
Miscelatore monocomando per lavello a muro, con leva frontale e bocca girevole modello corto.



**G 41 4**  
Miscelatore monocomando per lavello a muro, con bocca girevole, lunga 20 cm.



**G 41 4S**  
Miscelatore monocomando per lavello a muro, con bocca a "S" girevole, lunga 21 cm.

100

ACCESSORI PER RUBINETTERIA



# KISS

## CARATTERISTICHE TECNICHE:

La serie è dotata di cartuccia a dischi ceramici Ø 40 mm, prodotta da S.T.S.R. – Studio Tecnico Sviluppo e Ricerche - [www.stsr.it](http://www.stsr.it).  
Finiture disponibili: cromo, cromo oro.

### SIMBOLOGIE:

 Con scarico e troppo pieno	 Con scarico in plastica	 Con Click-Clack con Troppo Pieno	 Senza scarico	 Proporzione perfetta.	 Con Kit Doccia e flessibile lungo: 120, 150 o 200 cm	 Doccetta Anticalcare	 Lavello sottofinestra con canna girevole	 Canna girevole	 Canna alta girevole
 Doccetta estraibile	 Acqua Potabile	 Con getto a cascata.	 Getto con massaggio intenso a risparmio idrico	 Massaggio vigoroso ampia copertura effetto pioggia	 Getto effetto pioggia	 Getto ad ampia copertura effetto pioggia	 Massaggio con getto vigoroso concentrato	 NEW Prodotto novità	

### MANIGLIE:

K 10



K 10 2



K 10 3



K 10 4



## LAVABI



K 10

Miscelatore monocomando lavabo con scarico.



K 10 P

Miscelatore monocomando lavabo con scarico in plastica.



K 11

Miscelatore monocomando lavabo senza scarico.



K 11 G

Miscelatore monocomando per lavabo o lavello, con bocca girevole.



**K 10 L**

Miscelatore monocomando per lavabo, con bocca lunga e scarico.



**K 10 LP**

Miscelatore monocomando per lavabo, con bocca lunga e scarico in plastica.



**K 11 L**

Miscelatore monocomando per lavabo, con bocca lunga senza scarico.



**K 10 E**

Miscelatore monocomando lavabo con bocca estraibile con scarico.

PROJECT

**BIDET**



**K 20**

Miscelatore monocomando per bidet, con aeratore direzionabile e scarico.



**K 20 P**

Miscelatore monocomando per bidet, con aeratore direzionabile e scarico in plastica.



**K 21**

Miscelatore monocomando per bidet, con aeratore direzionabile, senza scarico.

TEN

GIGA FOUR



**K 22**

Miscelatore monocomando bidet con deviatore per bocca e doccia.



**K 23**

Miscelatore monocomando per bidet, con doccia.



**K 24**

Miscelatore monocomando per bidet, con deviatore e doccia.

KISS

REMIX

**VASCA**



**K 02**

Miscelatore monocomando per vasca, esterno, con doccia duplex.



**K 05**

Miscelatore monocomando per vasca, esterno, senza kit doccia.



**K 01**

Miscelatore monocomando per vasca senza deviatore e senza kit doccia.



**K 08 UK**

Miscelatore monocomando per vasca, su colonnette, con doccia duplex.

35

100



**K 03**

Miscelatore monoforo lavabo/vasca con deviatore integrato e kit doccia.



**K 07**

Miscelatore monocomando bordo vasca serie Kiss con deviatore integrato nella bocca, bocca pesante fusa e doccia estraibile con idromassaggio e anticalcare a 4 funzioni.



**K 49**

Miscelatore lavabo/vasca con canna fusa lunga 30 cm e deviatore con kit doccia.

ACCESSORI PER RUBINETTERIA



**K 04**

Miscelatore monoforo lavabo/vasca con deviatore integrato senza kit doccia.



**K 07 UF**

Miscelatore monocomando bordo vasca con deviatore integrato nel miscelatore, bocca pesante fusa con effetto a cascata e doccetta estraibile con idromassaggio e anticalcare a 4 funzioni.



**K 46**

Miscelatore lavabo/vasca con canna fusa lunga 30 cm e deviatore senza kit doccia.

## DOCCE



**311 311DA**

Saliscendi con doccetta anticalcare, con getti in silicone.

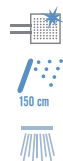

**K 38**

Miscelatore monocomando esterno per doccia, con doccia duplex e leva frontale.



**K 39**

Miscelatore monocomando esterno per doccia, con doccia duplex.



**K 33**

Miscelatore monocomando esterno per doccia con leva frontale.



**K 31**

Miscelatore monocomando esterno per doccia.

## INCASSI



**K 09**

Miscelatore monocomando incasso vasca/doccia con deviatore.



**K 30**

Miscelatore monocomando incasso doccia.

## BOX INCASSO



**RR BOX**

Box da incasso per miscelatore doccia con deviatore.

**NEW**

+



**K 30 KB**

Set miscelatore doccia da abbinare al box incasso.



**RR BOX**

Box da incasso per miscelatore doccia con deviatore.

+



**K 09 KB**

Set miscelatore doccia con deviatore da abbinare al box incasso.

BOCCHIE



**91**  
Bocca incasso miscelatore vasca-doccia.



**91 D**  
Bocca incasso vasca-doccia, con deviatore integrato.



**91 UF 07**  
Bocca bordo vasca con getto a cascata.

PROJECT

TEN

CUCINA

GIGA FOUR

KISS

REMIX

35

100

ACCESSORI PER RUBINETTERIA



**K 40**  
Miscelatore monocomando per lavello, con bocca girevole.



**K 47**  
Miscelatore monocomando per lavello, con doccia estraibile a getto variabile.



**K 42**  
Miscelatore monocomando per lavello, con bocca alta girevole.



**K 42 C**  
Miscelatore monocomando per lavello, con bocca girevole a "C", tipo lusso, modello corto.



**K 42 U**  
Miscelatore monocomando per lavello, con bocca alta a "U" girevole.



**K 42 R**  
Miscelatore monocomando monoforo 90° per lavello, con bocca alta girevole ed orientabile, tipo lusso, modello sottofinestra.



**K 43**  
Miscelatore monocomando per lavello a muro, con leva frontale e bocca alta girevole.



**K 43 C**  
Miscelatore monocomando per lavello a muro, con leva frontale e bocca a "C" girevole, modello corto.



**K 41**  
Miscelatore monocomando per lavello a muro, con bocca girevole lunghezza 20 cm.



**K 41 S**  
Miscelatore monocomando per lavello a muro, con bocca a "S" girevole lunghezza 21 cm.



KISS

## LINEA CLINICA BAGNO



**K 14**

Miscelatore lavabo con scarico e leva lunga.



**K 14 L**

Miscelatore lavabo con bocca lunga, scarico e leva lunga.



**K 11 G LL**

Miscelatore monocomando per lavabo o lavello, con bocca girevole e leva lunga, senza scarico.

## LINEA CLINICA DOCCIA



**K 31 LL**

Miscelatore monocomando esterno per doccia con leva lunga senza kit doccia.



**K 39 LL**

Miscelatore monocomando esterno per doccia con leva lunga e doccia duplex.

## LINEA CLINICA CUCINA



**K 44**

Miscelatore lavello con bocca girevole e leva lunga.



**K 42 LL**

Miscelatore monocomando per lavello, con bocca alta girevole e leva lunga.



**K 47 LL**

Miscelatore monocomando per lavello con leva lunga e doccia estraibile a getto variabile.



**K 45**

Miscelatore monocomando per lavello a muro con leva lunga e bocca girevole lunghezza 20 cm.



**K 45 S**

Miscelatore monocomando per lavello a muro con leva lunga e bocca a "S" girevole lunghezza 21 cm.



**MA 14**

Leva lunga per miscelatori con cartuccia diam.40.

## LINEA PARRUCCHIERE



**K 66**

Mixer per acconciatore completo con doccia estraibile.



LINEA ACQUA POTABILE



**K 40 AP**

Miscelatore monocomando per lavello, con bocca girevole, con selettore per acqua potabile (tre vie di ingresso).



**K 40 DW**

Miscelatore lavello a tre vie di ingresso con bocca girevole, con selezione acqua potabile tramite la leva, con 2 aeratori in uscita.

PROJECT

TEN

LINEA BASSA PRESSIONE



**K 40 BP**

Miscelatore monocomando per lavello, con bocca girevole, per bassa pressione.



**K 40 BPC**

Miscelatore monocomando per lavabo o lavello, con bocca girevole corta, per bassa pressione.



**K 41 BP**

Miscelatore monocomando per lavello a muro, con bocca girevole, per bassa pressione.

GIGA FOUR

KISS

LINEA MONO ACQUA



**K 10 M**

Miscelatore monocomando e monoacqua per lavabo con scarico.



**K 11 M**

Miscelatore monocomando e monoacqua per lavabo senza scarico.



**K 11 G M**

Miscelatore monocomando e monoacqua per lavabo o lavello, con bocca girevole, senza scarico.

REMIX

35



**K 42 U M**

Miscelatore monocomando monoacqua per lavello, con bocca alta a "U" girevole.



**K 40 M**

Miscelatore monocomando mono acqua per lavello, con bocca girevole.



**K 47 M**

Miscelatore monocomando monoacqua per lavello, con doccia estraibile a getto variabile.

100



**K 42 M**

Miscelatore monocomando mono acqua per lavello, con bocca alta girevole.



**K 42 CM**

Miscelatore monocomando mono acqua per lavello, con bocca girevole a "C", tipo lusso, modello corto.

ACCESSORI PER RUBINETTERIA



# REMIX

## CARATTERISTICHE TECNICHE:

La serie è dotata di cartuccia a dischi ceramici Ø 35 mm, prodotta da S.T.S.R. – Studio Tecnico Sviluppo e Ricerche - [www.stsr.it](http://www.stsr.it).  
Finiture disponibili: cromo.

### SIMBOLOGIE:

- |   |  |   |  |   |   |   |   |   |  |
|---|--|---|--|---|---|---|---|---|--|
| <br>Con scarico e troppo pieno | <br>Con scarico in plastica | <br>Senza scarico  | <br>Proporzione perfetta. | <br>Con Kit Doccia e flessibile lungo: 120, 150 o 200 cm | <br>Doccetta Anticalcare                             | <br>Soffione Anticalcare ed Autopulente       | <br>Lavello sottofinestra con canna girevole | <br>Canna girevole | <br>Canna alta girevole |
| <br>Doccetta estraibile        | <br>Con getto a cascata.    | <br>Getto soft aerato misciato ad un getto vigoroso a risparmio idrico | <br>Getto effetto pioggia | <br>Massaggio vigoroso ampia copertura effetto pioggia   | <br>Getto con massaggio intenso a risparmio idrico | <br>Getto ad ampia copertura effetto pioggia |   |   |  |

### MANIGLIE:



## LAVABI E BIDET



**R 10**  
Miscelatore monocomando per lavabo con scarico.



**R 10 P**  
Miscelatore monocomando per lavabo con scarico in plastica.



**R 11**  
Miscelatore monocomando per lavabo senza scarico.



**R 11 G**  
Miscelatore monocomando per lavabo o lavello, con bocca girevole.



**R 20**  
Miscelatore monocomando per bidet con scarico.



**R 20 P**  
Miscelatore monocomando per bidet con scarico in plastica.



**R 21**  
Miscelatore monocomando per bidet senza scarico.

**VASCA**



**R 02**  
Miscelatore monocomando per vasca, esterno, con doccia duplex.



**R 05**  
Miscelatore monocomando per vasca, esterno, senza kit doccia.



**R 07**  
Miscelatore monocomando bordo vasca serie Remix con deviatore integrato nella bocca, bocca fusa e doccetta estraibile ad 1 funzione.



**R 49**  
Miscelatore lavabo/vasca con canna fusa lunga 30 cm e deviatore con kit doccia.



**R 46**  
Miscelatore lavabo/vasca con canna fusa lunga 30 cm e deviatore senza kit doccia.

**DOCCE**



**R 39**  
Miscelatore monocomando esterno per doccia, con doccia duplex.



**R 31**  
Miscelatore monocomando esterno per doccia senza kit doccia.



**311 311DA**  
Saliscendi con doccetta anticalcare, con getti in silicone.

PROJECT

TEN

GIGA FOUR

KISS

REMIX

35

100

ACCESSORI PER RUBINETTERIA



REMIX



**R 38**

Miscelatore monocomando esterno per doccia, con leva frontale e doccia duplex.



**R 33**

Miscelatore monocomando esterno per doccia, con leva frontale, senza kit doccia.



**R 37**

Gruppo doccia con colonna saliscendi e deviatore, completa di doccetta anticalcare 4 getti art. 321GR, flessibile e soffione art. 358GR 4 getti anticalcare.

## INCASSI



**R 09**

Miscelatore monocomando da incasso con deviatore per vasca/doccia.

**L 09 B**

Parte interna miscelatore monocomando incasso vasca/doccia con deviatore.

**R 09 E**

Parte esterna miscelatore monocomando incasso vasca/doccia con deviatore.



**R 30**

Miscelatore monocomando da incasso per doccia.

**L 30 B**

Parte interna miscelatore monocomando incasso doccia.

**R 30 E**

Parte esterna miscelatore monocomando incasso doccia.

## BOX INCASSO



**NEW**

+



**RR BOX**

Box da incasso per miscelatore doccia con deviatore.

**R 30 KB**

Set miscelatore doccia da abbinare al box incasso.



+

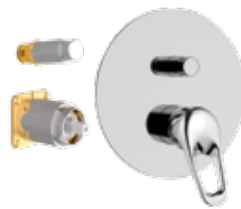

**RR BOX**

Box da incasso per miscelatore doccia con deviatore.

**R 09 KB**

Set miscelatore doccia con deviatore da abbinare al box incasso.

## BOCCE



**91**

Bocca incasso per miscelatore vasca-doccia.



**91 D**

Bocca incasso vasca-doccia, con deviatore integrato.

CUCINA

PROJECT

TEN

GIGA FOUR

KISS

REMIX

35

100

ACCESSORI PER RUBINETTERIA



R 40

Miscelatore monocomando per lavello, con bocca girevole.



R 42 B

Miscelatore monocomando per lavello, con bocca alta girevole.



R 42 R

Miscelatore monocomando monoforo 90° per lavello, con bocca alta girevole ed orientabile, tipo lusso, modello sottofinestra.



R 42

Miscelatore monocomando per lavello, con bocca alta girevole.



R 42 C

Miscelatore monocomando per lavello, con bocca a "C" girevole, tipo lusso modello corto.



R 42 U

Miscelatore monocomando per lavello, con bocca alta a "U" girevole.



R 41

Miscelatore monocomando per lavello a muro, con bocca girevole, lunghezza 20 cm.



R 41 S

Miscelatore monocomando per lavello a muro, con bocca a "S" girevole, lunghezza 21 cm.



R 43

Miscelatore monocomando per lavello a muro, con leva frontale e bocca alta girevole.



R 43 C

Miscelatore monocomando per lavello a muro, con leva frontale e bocca a "C" girevole, modello corto.

LINEA MONO ACQUA



R 11 G M

Miscelatore monocomando e mono acqua per lavabo o lavello, con bocca girevole.



R 40 M

Miscelatore monocomando mono acqua per lavello, con bocca girevole.



R 42 M

Miscelatore monocomando mono acqua per lavello, con bocca alta girevole.



R 42 CM

Miscelatore monocomando mono acqua per lavello, con bocca a "C" girevole, tipo lusso, modello corto.



R 42 UM

Miscelatore monocomando mono acqua per lavello, con bocca alta a "U" girevole.



# 35

## CARATTERISTICHE TECNICHE:

La serie è dotata di cartuccia a dischi ceramici Ø 35 mm, prodotta da S.T.S.R. – Studio Tecnico Sviluppo e Ricerche - [www.stsr.it](http://www.stsr.it).  
Finiture disponibili: cromo.

### SIMBOLOGIE:

- |  |   |   |   |   |   |  |   |   |  |
|--|---|---|---|---|---|--|---|---|--|
| <br>Con scarico e troppo pieno      | <br>PLASTIC<br>Con scarico in plastica | <br>Senza scarico  | <br>PERFECT MIX<br>Proporzione perfetta. | <br>Con Kit Doccia e flessibile lungo: 120, 150 o 200 cm | <br>Doccetta Anticalcare                             | <br>SELF-CLEANING<br>Soffione Anticalcare ed Autopulente | <br>Lavello sottofinestra con canna girevole | <br>Canna girevole | <br>HIGH<br>Canna alta girevole |
| <br>PULL-OUT<br>Doccetta estraibile | <br>Con getto a cascata.               | <br>Getto soft aerato misciato ad un getto vigoroso a risparmio idrico | <br>Getto effetto pioggia                | <br>Massaggio vigoroso ampia copertura effetto pioggia   | <br>Getto con massaggio intenso a risparmio idrico | <br>Getto ad ampia copertura effetto pioggia            |   |   |  |

### MANIGLIE:



## LAVABI E BIDET



**F 10 2**  
Miscelatore monocomando per lavabo con scarico in plastica.



**F 10 2 SO**  
Miscelatore monocomando per lavabo con scarico.



**F 11 2**  
Miscelatore monocomando per lavabo senza scarico.



**F 11 2G**  
Miscelatore monocomando per lavabo o lavello, con bocca girevole.





**F 20 2**  
Miscelatore monocomando per bidet con aeratore direzionabile e scarico in plastica.



**F 20 2 S0**  
Miscelatore monocomando per bidet con aeratore direzionabile e scarico.



**F 21 2**  
Miscelatore monocomando per bidet con aeratore direzionabile senza scarico.



**F 23 2**  
Miscelatore monocomando per bidet, con doccetta spray.

PROJECT

VASCHE



**F 02 2**  
Miscelatore monocomando per vasca, esterno, con doccia duplex.



**F 49 2**  
Miscelatore lavabo/vasca con canna fusa lunga 30 cm e deviatore con kit doccia.



**F 07 2**  
Miscelatore monocomando bordo vasca serie 35 con deviatore integrato nella bocca, bocca fusa e doccetta estraibile ad 1 funzione

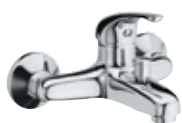

**F 05 2**  
Miscelatore monocomando per vasca, esterno, senza kit doccia.



**F 46 2**  
Miscelatore lavabo/vasca con canna fusa lunga 30 cm e deviatore senza kit doccia.

TEN

GIGA FOUR

KISS

REMIX

35

DOCCE



**F 31 2**  
Miscelatore monocomando esterno per doccia senza kit doccia.



**F 39 2**  
Miscelatore monocomando esterno per doccia, con doccia duplex.



**F 33 2**  
Miscelatore monocomando esterno per doccia, con leva frontale, senza kit doccia.



**F 38 2**  
Miscelatore monocomando esterno per doccia, con leva frontale e doccia duplex.

100

ACCESSORI PER RUBINETTERIA



35

## BOCCHIE ED INCASSI



**F 09 2**

Miscelatore monocomando da incasso con deviatore per vasca/doccia.

**L 09 B**

Parte interna miscelatore monocomando incasso vasca/doccia con deviatore.

**F 09 E**

Parte esterna miscelatore monocomando incasso vasca/doccia con deviatore.



**F 30 2**

Miscelatore monocomando da incasso per doccia.

**L 30 B**

Parte interna miscelatore monocomando incasso doccia.

**F 30 E**

Parte esterna miscelatore monocomando incasso doccia.



**91**

Bocca incasso per miscelatore vasca-doccia.



**91 D**

Bocca incasso vasca-doccia, con deviatore integrato.

## BOX INCASSO



**RR BOX**

Box da incasso per miscelatore doccia con deviatore.

**F 30 KB**

Set miscelatore doccia da abbinare al box incasso.



**RR BOX**

Box da incasso per miscelatore doccia con deviatore.

**F 09 KB**

Set miscelatore doccia con deviatore da abbinare al box incasso.

## DOCCE



**F 36 2**

Gruppo doccia con colonna lusso e soffione doccia art. 358GR, 4 getti, anticalcare.



**F 36 2 EX**

Gruppo doccia con colonna 329 EX, e soffione doccia art. 351 A, anticalcare.

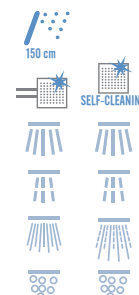

**F 37 2**

Gruppo doccia con colonna saliscendi e deviatore, completa di doccetta anticalcare 4 getti art. 321GR, flessibile e soffione art. 358GR 4 getti anticalcare.

CUCINA



**F 40 2**  
Miscelatore monocomando per lavello, con bocca girevole.



**F 41 2**  
Miscelatore monocomando per lavello a muro, con bocca girevole, lunghezza 20 cm.



**F 41 2S**  
Miscelatore monocomando per lavello a muro, con bocca a "S" girevole, lunghezza 21 cm.



**F 42 2**  
Miscelatore monocomando per lavello, con bocca alta girevole.



**F 42 2C**  
Miscelatore monocomando per lavello, con bocca alta girevole, modello corto.



**F 42 2U**  
Miscelatore monocomando per lavello, con bocca alta a "U" girevole.



**F 42 2R**  
Miscelatore monocomando monoforo 90° per lavello, con bocca alta girevole ed orientabile, tipo lusso, modello sottofinestra.



**F 43 2**  
Miscelatore monocomando per lavello a muro, con leva frontale e bocca alta girevole.



**F 43 2C**  
Miscelatore monocomando per lavello a muro, con leva frontale e bocca a "C" girevole, modello corto.

LINEA MONO ACQUA



**F 11 2 G M**  
Miscelatore monocomando e mono acqua per lavabo o lavello, con bocca girevole.



**F 40 2 M**  
Miscelatore monocomando mono acqua per lavello, con bocca girevole.



**F 42 2 M**  
Miscelatore monocomando mono acqua per lavello, con bocca alta girevole.



**F 42 2 CM**  
Miscelatore monocomando mono acqua per lavello, con bocca a "C" girevole, tipo lusso, modello corto.



**F 42 2 UM**  
Miscelatore monocomando mono acqua per lavello, con bocca alta a "U" girevole.

PROJECT

TEN

GIGA FOUR

KISS

REMIX

35

100

ACCESSORI PER RUBINETTERIA



# 100

## CARATTERISTICHE TECNICHE:

La serie è dotata di cartuccia a dischi ceramici Ø 35 mm, prodotta da S.T.S.R. – Studio Tecnico Sviluppo e Ricerche - [www.stsr.it](http://www.stsr.it) - Interasse 100 mm. Finiture disponibili: cromo.

### SIMBOLOGIE:

 Proporzione perfetta.

 Con Kit Doccia e flessibile lungo: 120, 150 o 200 cm

 Doccetta Anticalcare

 Canna girevole

 Canna alta girevole

 Massaggio con getto vigoroso concentrato

 Massaggio vigoroso ampia copertura effetto pioggia

### MANIGLIE:

C 43



C 43 2



C 43 3



C 43 4



## VASCHE

C 02 2

Miscelatore monocomando per vasca interasse 100, esterno, con doccia duplex.



C 05 2

Miscelatore monocomando per vasca, interasse 100, esterno, senza kit doccia.

C 49 2

Miscelatore lavabo/vasca con canna fusa lunga 30 cm e deviatore con kit doccia, interasse 100.



C 46 2

Miscelatore lavabo/vasca con canna fusa lunga 30 cm e deviatore senza kit doccia, interasse 100.



DOCCE



**C 311DA**

Saliscendi con doccetta anticalcare, con getti in silicone.

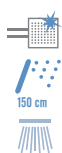

**C 312**

Miscelatore monocomando esterno per doccia, intersasse 100, senza kit doccia.



**C 392**

Miscelatore monocomando per doccia, intersasse 100, con doccia duplex.



**C 332**

Miscelatore monocomando, intersasse 100, esterno per doccia, con leva frontale, senza kit doccia.



**C 382**

Miscelatore monocomando esterno per doccia, intersasse 100, con leva frontale e doccia duplex.

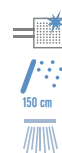

CUCINA

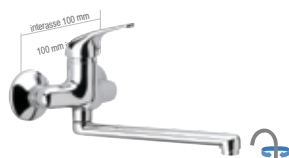

**C 412**

Miscelatore monocomando per lavello a muro, con bocca girevole, intersasse 100, lunghezza bocca 20 cm.



**C 412 S**

Miscelatore monocomando per lavello a muro, con bocca a "S" girevole, intersasse 100, lunghezza boca 21 cm.



**C 432**

Miscelatore monocomando esterno per lavello con leva frontale e bocca alta, intersasse 100.



**C 432 C**

Miscelatore monocomando esterno per lavello con leva frontale e canna a "C" corta fusa, modello corto.



SHUT-OFF



**C 312 DP**

Esterno doccia, intersasse 100 mm, doccetta shut-off in ABS cromato Art. 332DPCR e flessibile da 120 cm.



**C 312 REL**

Esterno doccia, intersasse 100 mm, doccetta shut-off in ottone cromato Art. 332OL e flessibile da 120 cm.



**C 312 RELA**

Esterno doccia, intersasse 100 mm, doccetta shut-off in ottone cromato Art. 332OLA e flessibile da 120 cm.



**C 332 DP**

Esterno doccia con leva frontale, intersasse 100 mm, doccetta shut-off in ABS cromato Art. 332DPCR e flessibile da 120 cm.



**C 332 REL**

Esterno doccia con leva frontale, intersasse 100 mm, doccetta shut-off in ottone cromato Art. 332OL e flessibile da 120 cm.



**C 332 RELA**

Esterno doccia con leva frontale, intersasse 100 mm, doccetta shut-off in ottone cromato Art. 332OLA e flessibile da 120 cm.



PROJECT

TEN

GIGA FOUR

KISS

REMIX

35

100

ACCESSORI PER RUBINETTERIA

# ACCESSORI PER RUBINETTERIA





PROJECT

TEN

GIGA FOUR

KISS

REMIX

35

100

ACCESSORI PER  
RUBINETTERIA

SIMBOLOGIE:



Canna girevole



Canna alta girevole



Prodotto Novità



Proporzione perfetta.



GRUPPO

RUBINETTI

61



Rubinetto prolungato con comando a gomito, 1/2.

63



Rubinetto a snodo con comando a gomito, 1/2, con canna inferiore.

64



Gruppo lavello con comando a gomito e canna inferiore.

14 LL



Gruppo lavello tipo a ponte con comando a gomito e canna Ø 18 mm.

65



Rubinetto collo cigno con comando a gomito, 1/2.

61 LE



Leva in ottone cromato per articoli 61, 63, 64, 65, 14LL.

MA 14



Leva lunga per miscelatori con cartuccia Ø 40.

61 VI



Vitone da 1/2 per articoli 61, 63, 64, 65, 14LL.

66

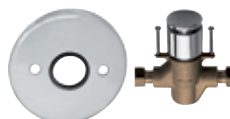

Rubinetto a pedale ad incasso in ottone cromato.

66 MP



Rubinetto-miscelatore pedaliera universale. Può essere installato sia a parete che a pavimento.

67



Bocca a snodo per lavello.

67 N



Bocca alta minimale.

67 Q



Bocca alta quadrata.

69



Rubinetto a pulsante a zampillo parabolico per refrigeratore o depuratore. Regolazione del getto sotto il pulsante.

CARTUCCE



P 50

Cartuccia progressiva Ø 35, con distributori, con chiusura del flusso e uscita dell'acqua verso il basso.



P 52

Cartuccia progressiva Ø 35, senza distributori, con chiusura del flusso e uscita dell'acqua verso il basso.



V 50 C

Cartuccia a dischi ceramici Ø 25 mm, tipo piatto.



V 50 A

Cartuccia a dischi ceramici Ø 25, con uscita dell'acqua direttamente dalla parte alta dell'involucro a cilindro senza quindi essere riconvolgiato verso il fondo della cartuccia.



**J 50**  
Cartuccia a dischi ceramici Ø mm 35, movimento a "joystick", tipo piatto.



**E 50 C**  
Cartuccia termostatica coassiale serie MINIMAL THERMO e QUBIKA THERMO.



**E 50 P**  
Cartuccia termostatica con rotazione manopola a 330° angolari, blocco di sicurezza a 38°C, campo di lavoro da 5°C a 80°C, campo di pressione da 1 a 10 bar, filtro inox e sistema di sicurezza con blocco dell'erogazione in caso di mancanza di una delle due acque, realizzato con materiali termoplastici ad elevata robustezza.



**E 50**  
Cartuccia termostatica con rotazione manopola a 330° angolari, blocco di sicurezza a 38°C, campo di lavoro da 5°C a 80°C, campo di pressione da 1 a 10 bar, filtro inox e sistema di sicurezza con blocco dell'erogazione in caso di mancanza di una delle due acque.

PROJECT

TEN

GIGA FOUR

KISS

REMIX

35

100

ACCESSORI PER RUBINETTERIA

## CARTUCCE IN BLISTER



**S 50**  
Cartuccia Ø mm 40 a dischi in ceramica per vasca, lavabo, bidet (tipo con distributori).



**S 52**  
Cartuccia Ø mm 40 a dischi in ceramica per lavello, doccia (tipo piatto).



**R 50**  
Cartuccia Ø mm 35 a dischi in ceramica per vasca, lavabo, bidet (tipo con distributori).



**R 52**  
Cartuccia Ø mm 35 a dischi in ceramica per lavello, doccia (tipo piatto).



**S 50 AF**  
Cartuccia ad apertura forzata Ø mm 40 a dischi ceramici per vasca, lavabo, bidet (tipo con distributori) permette un notevole risparmio idrico.

CLICK SYSTEM



**S 52 AF**  
Cartuccia ad apertura forzata Ø mm 40 a dischi ceramici per lavello, doccia (tipo piatto) permette un notevole risparmio idrico.

CLICK SYSTEM



**R 50 AF**  
Cartuccia ad apertura forzata Ø 35 mm a dischi ceramici per vasca, lavabo, bidet (tipo con distributori) permette un notevole risparmio idrico.

CLICK SYSTEM



**R 52 AF**  
Cartuccia ad apertura forzata Ø 35 mm a dischi ceramici per lavello, doccia (tipo piatto) permette un notevole risparmio idrico.

CLICK SYSTEM



**W 50**  
Cartuccia Ø mm 35 a dischi ceramica per lavello, doccia, vasca, bidet (tipo piatto).

## DEVIATORI



### Q 34 DEV 5

Deviatore a 5 posizioni per doccia (1 via in entrata e 5 vie in uscita) su piastra, serie Qubika.



### Q 93 DEV 3

Deviatore a tre vie (una entrata e tre uscite) su piastra, serie Qubika.



### Q 93 DEV 7

Deviatore a tre vie e sette posizioni (una entrata, tre uscite e sette posizioni con cui selezionare uscite singole o miscelate tra loro) su piastra, serie Qubika.



### N 34 DEV 5

Deviatore a 5 posizioni per doccia (1 via in entrata e 5 vie in uscita) su piastra, serie Minimal.



### N 93 DEV 3

Deviatore a tre vie (una entrata e tre uscite) su piastra, serie Minimal.



### N 93 DEV 7

Deviatore a tre vie e sette posizioni (una entrata, tre uscite e sette posizioni con cui selezionare uscite singole o miscelate tra loro) su piastra, serie Minimal.

## PROLUNGHE



### K 09 PROL

Prolunga per corpo monocomando doccia incasso con deviatore per cartuccia Ø 40 mm.



### N 09 PROL

Prolunga per corpo monocomando doccia incasso con deviatore per cartuccia Ø 35 mm.



### S 52 PROL

Prolunga per corpo monocomando doccia incasso con cartuccia Ø 40 mm.



### R 52 PROL

Prolunga per corpo monocomando doccia incasso con cartuccia Ø 35 mm.

## DEVIATORI AUTOMATICI



### 78

Vite fissa maniglia.



### 80 SN

Morsetto con vite per scarico automatico.



### DEV 00

Deviatore in ottone automatico con molla e fermo per basse pressioni.



### DEV 08

Deviatore in ottone automatico con molla e fermo, con prolunga 8 mm.



### DEV 13

Deviatore in ottone automatico con molla e fermo, con prolunga 13 mm.

## VITONI



**75**  
Vitone universale per rubinetti, che permette di ottenere 102 combinazioni di misure e lunghezze. Confezione skin-pack.



**77 19**  
Vitone con filetto 19/19, per rubinetti incasso.



**74**  
Vitone da 1/2 per gruppo vasca, lavello, batteria lavabo, rubinetto bidet e incasso per art. 53, 55.



**74 E**  
Come 74, tipo leggero.



**74 F**  
Vitone da 1/2 con filetto per coprivitone M24x1.



**77 18**  
Vitone filetto 18/19 per art. 221, 223, 224, 250, 252 e altri.



**77 38**  
Vitone con filetto 3/8, per rubinetti.



**76 DX 180**  
Vitone 180° a dischi ceramici, broccia Ø mm 8, 20 denti, destro.



**76 DX 24**  
Vitone 90° a dischi ceramici, broccia Ø 8 mm, 24 denti, destro.



**76 DX**  
Vitone 90° a dischi ceramici, broccia Ø 8 mm, 20 denti, destro.



**76 SX 180**  
Vitone 180° a dischi ceramici, broccia Ø mm 8, 20 denti, sinistro.



**76 SX 24**  
Vitone 90° a dischi ceramici, broccia Ø 8 mm, 24 denti, sinistro.



**76 SX**  
Vitone 90° a dischi ceramici, broccia Ø 8 mm, 20 denti, sinistro.

PROJECT

TEN

GIGA FOUR

KISS

REMIX

35

100

ACCESSORI PER  
RUBINETTERIA

AERATORI



**81 A**  
Aeratore anticalcare ad alta tecnologia F22, brevettato e di lunghissima durata, scocca in ottone ed interno in materiale plastico innovativo a forte resistenza.



**83 A**  
Aeratore anticalcare ad alta tecnologia M24, brevettato e di lunghissima durata, scocca in ottone ed interno in materiale plastico innovativo a forte resistenza.



**83 C**  
Chiave brevettata per la pulizia settimanale degli aeratori ad alta tecnologia art 81 A e art 83 A.



**81**  
Aeratore classico con retine in inox, per gruppo lavello F22.



**83**  
Aeratore classico con retine in inox, per lavabo, lavello e bidet M24.



**84**  
Aeratore per gruppo vasca, M28.



**83 F16**  
Aeratore F16.



**81 SN**  
Snodo attacco F22 con ghiera M22.



**83 SN**  
Snodo attacco M22 con ghiera M24.



**83 N41**  
Aeratore M18.



**85**  
Aeratore con snodo per monoforo bidet, M24.



**83 NE SI**  
Aeratore Neoperl autopulente M24X1 con erogatore in silicone morbido anticalcare per una pulizia manuale semplificata.



**83 NE**  
Aeratore Neoperl effetto a scomparsa, con filetto M24X1 che puo' essere sostituito senza difficoltà a tutte le rubinetterie con filettatura per aeratore M24X1. Molto indicato per modelli di design quali Qubika, Minimal, SQ.



**83 NE BA**  
Aeratore Neoperl M24X1 con getto direzionabile tramite terminale basculante, permette con il semplice tocco della parte inferiore dell'aeratore di dirigere il flusso della direzione desiderata.



**83 EU**  
Aeratore Neoperl M24 coin slot. Installazione e rimozione dell'aeratore utilizzando una moneta inserita nell'apposita fessura.



**83 Z40**  
Aeratore M24 ultrapiatto, utilizzabile su ogni lavabo o lavello. Installazione e rimozione con chiave 83 Z40 C.



**83 Z40 C**  
Chiave brevettata per la pulizia settimanale degli aeratori ad alta tecnologia art 83 Z40.





## AERATORI: LINEA RISPARMIO IDRICO-ENERGICO E ANTIVANDALICO



**83 AVC**

Kit antivandalico e anticalcare composto da aeratore speciale per miscelatori lavabo e bidet M24 e chiave di montaggio, manutenzione e pulizia settimanale, ad alta tecnologia, brevettata.



**83 SET L6 - 83 SET L8**

Set risparmio idrico totale composto da raccordo doccia 1/2" in ottone cromato a portata limitata, aeratore lavabo e bidet M24 a portata limitata e chiave di montaggio manutenzione e pulizia settimanale, ad alta tecnologia, brevettata. Il kit è disponibile in varianti da 6 litri al minuto (cod 83 SET L6) o 8 litri al minuto (cod 83 SET L8).



**83 L6 - 83 L8**

Aeratore lavabo e bidet M24, per risparmio idrico con limitatore di portata da 6 litri al minuto (art. 83 L6) o da 8 litri al minuto (art. 83 L8).



**83 AVC L6 - 83 AVC L8**

Kit come 83 AVC, più risparmio idrico, che include anche limitatore di portata da 6 litri al minuto, art 83AVC L6, o limitatore di portata da 8 litri al minuto, art 83 AVC L8.



**309R L6 - 309R L8**

Raccordo doccia 1/2" a risparmio idrico con limitatore di portata da 6 litri al minuto (art 309 L6) o 8 litri al minuto (art 309 L8).



**662 FI 12**

€ 0,29

Guarnizione da 1/2" con filtro retinato anti-impurità.



**662 RE 12**

Guarnizione da 1/2" a passaggio ridotto, con risparmio idrico del 30%.



## KIT PULIZIA AERATORE



**83 SET 01**

Set completo di 3 aeratori anticalcare M24 ad alta tecnologia + 1 chiave per la pulizia settimanale, brevettati e di lunghissima durata, il tutto in ottone cromato e materiale plastico innovativo a forte resistenza, confezionato in un tubo contenitore rigido e trasparente adatto per essere appeso. La chiave è stata studiata per pulire il calcare dall'aeratore in un solo semplice movimento.



**83 SET 02**

Set completo di 2 aeratori anticalcare M24 ad alta tecnologia ed e 1 aeratore anticalcare F22 + 1 chiave per la pulizia settimanale, brevettati e di lunghissima durata, il tutto in ottone cromato e materiale plastico innovativo a forte resistenza, confezionato in un tubo contenitore rigido e trasparente adatto per essere appeso. La chiave è stata studiata per pulire il calcare dall'aeratore in un solo semplice movimento.

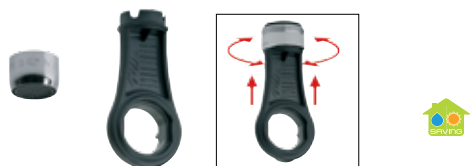

**81 AC**

Set completo di 1 aeratore F22 anticalcare ad alta tecnologia + 1 chiave di pulizia settimanale, brevettati e di lunghissima durata, il tutto in ottone cromato e materiale plastico innovativo a forte resistenza. L'aeratore e la chiave sono stati studiati per pulire il calcare dall'aeratore in un solo semplice movimento.



**83 AC**

Set completo di 1 aeratore M24 anticalcare ad alta tecnologia + 1 chiave di pulizia settimanale, brevettati e di lunghissima durata, il tutto in ottone cromato e materiale plastico innovativo a forte resistenza. L'aeratore e la chiave sono stati studiati per pulire il calcare dall'aeratore in un solo semplice movimento.

PROJECT

TEN

GIGA FOUR

KISS

REMIX

35

100

ACCESSORI PER RUBINETTERIA

RIDUZIONI



**81 RD 12**

Riduzione 1/2MxM22. Consente di collegare qualsiasi attacco da 1/2F", esempio tutti i flessibili doccia, con un aeratore standard lavabo/lavello F22, vedi ns articolo 81A (al posto di una doccetta o di uno shut off).



**81 RD 12M 22F**

Riduzione 1/2MxF22. Consente di collegare al lavabo/lavello F22 un qualsiasi componente con attacco 1/2F.



**83RD 12F 22F**

Riduzione 1/2FxF22. Consente di collegare al lavabo/lavello F22 un qualsiasi componente con attacco 1/2M.



**83 RD 12**

Riduzione 1/2MxF24. Consente di collegare qualsiasi attacco da 1/2F", esempio tutti i flessibili doccia, con un aeratore standard lavabo M24, vedi ns articolo 83A (al posto di una doccetta o di uno shut off).



**83 RD 12M 24M**

Riduzione 1/2MxM24. Consente di collegare al lavabo/lavello M24 un qualsiasi componente con attacco 1/2F.



**83RD 12F 24M**

Riduzione 1/2FxM24. Consente di collegare al lavabo/lavello M24 un qualsiasi componente con attacco 1/2M.



**82**

Aeroflux a due getti, con doccetta a snodo, filetto F22 con riduzione M24.



**82 DJ**

Aeroflux "Dual Jet" in ottone cromato a due getti, con doccetta a snodo e filetto F22.



**82 UN**

Aeroflux a due getti, con doccetta a snodo, con attacco universale.



**82 L**

Aeroflux a due getti, con manicotto a vite, lunghezza cm 15.



**82 LGH**

Aeroflux a due getti, con ghiera e filetto F22, lunghezza 15 cm.

ECCENTRICI E DISTANZIATORI



**89**  
Eccentrico per gruppi, 1/2 x 3/4, con rosone in ottone cromato.



**89 L**  
Eccentrico per gruppi, 1/2x3/4, tipo Lusso, con rosone in ottone cromato.



**89 N**  
Eccentrico per gruppi, 1/2 x 3/4, con rosone minimale in ottone cromato.



**90**  
Distanziatore per gruppi, 1/2x3/4, lunghezza cm.4, 6, 8.

PROJECT

TEN

COLONNE PER BORDO VASCA



**88 01 LI**

Coppia colonne vasca in ottone cromato, serie Liberty, 3/4M x 3/4M.



**88 01 LI S**

Coppia colonne vasca in ottone cromato, serie Liberty, con supporto doccia, 3/4M x 3/4M.

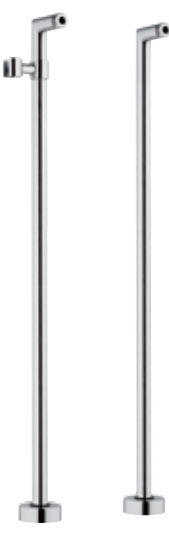

**88 N 02**

Coppia colonne vasca in ottone cromato, serie Minimal, con supporto doccia, 3/4M x 3/4M.

GIGA FOUR

KISS

REMIX

35

100



**88 UK**

Coppia colonnette bordo vasca in ottone cromato, serie UK, 3/4Mx3/4M.



**88 LI**

Coppia colonnette bordo vasca in ottone cromato, serie Liberty, 3/4M x 3/4M.



**88**

Colonneta per bordo vasca in ottone cromato, 1/2M x 3/4M.



**88 BI**

Colonneta per bordo vasca, verniciata bianca, 1/2M x 3/4M.

ACCESSORI PER RUBINETTERIA

BOCCHIE



**86**  
Canna lavello inferiore a "S", cm 22,5, tipo universale, con aeratore.



**86 N**  
Canna lavello inferiore a "S", cm 20, con aeratore.



**86 N 40**  
Canna lavello inferiore a "S", cm 40, con aeratore.

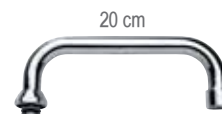

**86 U**  
Canna lavello superiore a "U", cm 20, con aeratore.



**87 N**  
Canna a "J" per monoforo lavello, con aeratore.



**87**  
Canna a "J" per monoforo lavello, tipo universale, con aeratore.



**92 C**  
Canna a biscotto a "C" con calotta da 3/4, con aeratore.



**92 CC**  
Canna a biscotto a "C" con calotta da 3/4, con aeratore, tipo corto.



**92 U**  
Canna a "U" Ø 22, con aeratore.



**93**  
Canna fusa lunga cm 30 con deviatore, con calotta da 3/4 ed aeratore.



**92 16**  
Canna a biscotto diritta, calotta da 3/4, lunghezza cm.16, con aeratore.

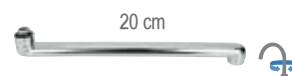

**92 20**  
Canna a biscotto diritta, calotta da 3/4, lunghezza cm.20, con aeratore.



**92 30**  
Canna a biscotto diritta, calotta da 3/4, lunghezza cm. 30, con aeratore.



**92 40**  
Canna a biscotto diritta, calotta da 3/4, lunghezza cm.40, con aeratore.



**92 50**  
Canna a biscotto diritta, calotta da 3/4, lunghezza cm. 50, con aeratore.



**92 S16**  
Canna a biscotto a "S", calotta da 3/4, lunghezza cm.16, con aeratore.



**92 S20**  
Canna a biscotto a "S", calotta da 3/4, lunghezza cm.20, con aeratore.

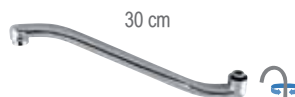

**92 S30**  
Canna a biscotto a "S", calotta da 3/4, lunghezza cm.30, con aeratore.

## SUPPORTI DOCCIA



**325 07**

Supporto per doccia estraibile per bordo lavello e bordo vasca, modello a base tonda.



**325 S 07**

Supporto dritto per doccia estraibile per bordo lavello e bordo vasca, modello a base quadra.

## SCARICHI



**95 TA**

Tappo scarico automatico in ottone per piletta 1" e per piletta 1"1/4.



**95 TAG**

Tappo grande in ottone cromato per scarico automatico con piletta da 1"1/4.



**95 TAS**

Tappo grande quadrato in ottone cromato per scarico automatico con piletta da 1"1/4.



**96 TA**

Tappo in ottone cromato per colonna vasca automatica.



**BA K10**

Basetta in ottone per rubinetteria tipo serie Kiss, Ten, Giga.

**94**

Asta per scarico automatico, lunghezza cm 30, in ottone cromato.



**95 AC**

Asta e centralina bidet per scarico automatico, in ottone cromato.



**95 Q AC**

Asta e centralina bidet per scarico automatico, in ottone cromato.



**AS T10**

Asta con pomolo e snodino per serie Ten, in ottone cromato.



**AS K10**

Asta con pomolo e snodino per serie Kiss, in ottone cromato.



**FIS K10**

Confezione di fissaggio per art. K10, K20, K40.



**FIS R10**

Confezione di fissaggio per art. R10, R20, R40.



**FIS T10**

Confezione di fissaggio a doppio tirante.



**FIS A10**

Confezione di fissaggio per: Atmos, Flash, Qubika Cascata.



**FIS B10**

Confezione di fissaggio per art. S42 U, S10 G, B10, B20, Q42U, Q10 G.

PROJECT

TEN

GIGA FOUR

KISS

REMIX

35

100

ACCESSORI PER RUBINETTERIA

## SCARICHI AUTOMATICI CLICK-CLACK



### 904 CC 2

Scarico automatico con sistema click-clack, 1"1/4, e tappo grande, senza troppo pieno, modello con bicchiere corto.



### 904 CC

Scarico automatico con sistema click-clack, 1"1/4, e tappo grande, senza troppo pieno.



### 904 SCC 2

Scarico automatico quadrato 1"1/4 con click-clack senza troppo pieno, modello con bicchiere corto.



### 904 SCC

Scarico automatico quadrato 1"1/4 con click-clack senza troppo pieno.



### 905 CC 2

Scarico automatico quadrato 1"1/4 con click-clack con troppo pieno, modello con bicchiere corto.



### 905 CC

Scarico automatico con sistema click-clack, 1"1/4, e tappo grande, con troppo pieno.



### 905 SCC 2

Scarico automatico quadrato 1"1/4 con click-clack con troppo pieno, modello con bicchiere corto.



### 905 SCC

Scarico automatico con sistema click-clack, 1"1/4, e tappo grande, con troppo pieno.



### 906 CC 2

Scarico automatico con sistema click-clack, 1"1/4, con troppo pieno, modello con bicchiere corto.



### 906 CC

Scarico automatico con sistema click-clack, 1"1/4, con troppo pieno.





## 907 2

Scarico automatico 1"1/4 con tappo grande sempre aperto e sistema click-clack per la pulizia interna, modello con bicchiere corto.



## 907

Scarico automatico 1"1/4 con tappo grande sempre aperto e sistema click-clack per la pulizia interna.



## 905 CCR

Scarico automatico universale con chiusura click-clack da 1"1/4.



## 905 CC XL 114

Scarico automatico con sistema click-clack, 1" 1/4, tappo grande, con troppo pieno, versione extralunga.

NEW

## SCARICHI AUTOMATICI



## 95

Scarico automatico 1", 1"1/4.



## 95 L

Scarico automatico da 1"1/4, tipo Lusso.



## 95 U

Scarico automatico da 1"1/4, tipo lusso lucidato.



## 95 UG

Scarico automatico da 1"1/4, tipo lusso lucidato, con tappo grande a copertura totale della piletta.



## 95 US

Scarico automatico da 1"1/4, tipo lusso lucidato, con tappo grande quadrato piatto a copertura totale della piletta.



## 95 P

Scarico automatico in plastica da 1"1/4.



## 95 AM

Scarico tipo America o Americano, in ottone pulito e cromato.

PROJECT

TEN

GIGA FOUR

KISS

REMIX

35

100

ACCESSORI PER RUBINETTERIA

## COPERTURA A PAVIMENTO IN ACCIAIO INOX



cm 10x10



### 913 GVC 10

Copertura a pavimento in acciaio inox cm 10x10, con griglia fissa e coperchio mobile.



### 913 GV 10

Copertura a pavimento in acciaio inox cm 10x10, con griglia fissa.

cm 15x15



### 913 GVC 15

Copertura a pavimento in acciaio inox cm 15x15, con griglia fissa e coperchio mobile.



### 913 GV 15

Copertura a pavimento in acciaio inox cm 15x15, con griglia fissa.



### 913 CV 15

Copertura a pavimento in acciaio inox cm 15x15, con coperchio avvitato fisso.



### 913 GFC 15

Copertura a pavimento in acciaio inox cm 15x15, con griglia e coperchio mobili.

cm 20x20



### 913 GVC 20

Copertura a pavimento in acciaio inox cm 20x20, con griglia fissa e coperchio mobile.



### 913 GV 20

Copertura a pavimento in acciaio inox cm 20x20, con griglia fissa.



### 913 CV 20

Copertura a pavimento in acciaio inox cm 20x20, con coperchio avvitato fisso.



### 913 GFC 20

Copertura a pavimento in acciaio inox cm 20x20, con griglia e coperchio mobili.

## SIFONI ANTI SCARAFAGGIO



### 913 PSA 01

Sifone anti-scarafaggio da utilizzare per coperture a pavimento cm 15x15 e 20x20



### 913 PSA 02

Sifone anti-scarafaggio da utilizzare per coperture a pavimento cm 10x10.

## CANALINE SIFONATE RETTANGOLARI



### 913 RG 12

Canalina sifonata a pavimento, in acciaio inox, con griglia di drenaggio, larghezza 12,5 cm lunghezze cm 70, 80, 90, 100, 120.

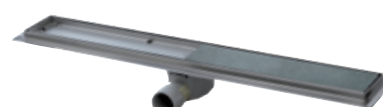

### 913 RP 12

Canalina sifonata a pavimento, in acciaio inox, piastrellabile, larghezza 12,5 cm lunghezze cm 70, 80, 90, 100, 120.

PILETTE DA PAVIMENTO SIFONATE



913 SF 10

Piletta da pavimento sifonata in acciaio inox, cm 10x10.



913 SF 15

Piletta da pavimento sifonata in acciaio inox, cm 15x15.



913 SF 20

Piletta da pavimento sifonata in acciaio inox, cm 20x20.

SIFONI



977

Sifone a "P" in tubo, in ottone cromato, 1" 1/4".



977X 114

Sifone "P" in tubo, in acciaio INOX, 1" 1/4.



970

Sifone a bottiglia in ottone cromato, canotto cm 25, 1" 1/4.



970 Z

Sifone a bottiglia in zama senza piletta, per lavabo, 1" 1/4, canotto cm. 30.



971

Sifone a "S" in ottone cromato, canotto cm 25, 1" 1/4.



971 Z

Sifone a "S" in zama, canotto cm 25, 1" 1/4.



972

Sifone a "U" per lavabo a colonna in ottone cromato, canotto cm 25, 1" 1/4.

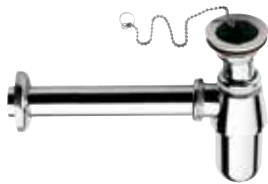

973 Z

Sifone a bottiglia in zama con piletta, per lavabo, 1" 1/4.



968

Ghiera per sifoni in ottone cromato, 1" M x 1" 1/4 F, 1" 1/4 M x 1" 1/2 F.



969

Ghiera per sifoni in ottone cromato, 1" 1/4 M x 1" F, 1" 1/2 M x 1" 1/4 F.

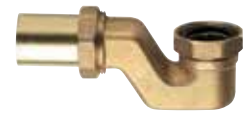

98

Sifone pesante in ottone fuso, con dado 1" 1/2 per colonna vasca.

PROJECT

TEN

GIGA FOUR

KISS

REMIX

35

100

ACCESSORI PER RUBINETTERIA

SIFONI



**958 L**

Sifone "MINIMAL" in ottone cromato, per lavabo, 1"1/4, canotto cm 30 e rosone pesante.



**958 B**

Sifone "MINIMAL" in ottone cromato, per bidet, 1"1/4, canotto cm 30 e rosone pesante.



**965**

Sifone esagonale in ottone cromato, 1"1/4, canotto cm 30 e rosone pesante.



**960**

Sifone SQ, in ottone cromato, canotto cm 30, 1"1/4, con rosone pesante quadrato.



**956**

Sifone fuso pesante lusso in ottone cromato, per lavabo e bidet 1", 1" 1/4 canotto cm 30.

SIFONI SALVASPAZIO



**985**

Sifone salvaspazio con piletta click-clack incorporata con troppo pieno, rotondo, cromato.



**984**

Sifone salvaspazio con piletta click-clack incorporata senza troppo pieno, rotondo, cromato.



**985 S**

Sifone salvaspazio con piletta click-clack incorporata con troppo pieno, quadrato, cromato.



**984 S**

Sifone salvaspazio con piletta click-clack incorporata senza troppo pieno, quadrato, cromato.

## COLONNE DI SCARICO



PROJECT



### 96 P

Colonna di scarico automatica in plastica con filo esterno, senza dado e codulo.



### 96 PCC

Colonna di scarico in plastica, con piletta "click-clack".

TEN

GIGA FOUR



### 96 LI CC

Colonna di scarico con sifone per vasca con tubo in rame cromato e piletta click-clack, tutta cromata.



### 96 LI T

Colonna di scarico con sifone per vasca con tubo in rame cromato, tutta cromata.

KISS

REMIK

35



### 96

Colonna di scarico automatica con filo esterno e tubo in rame senza dado e codulo.



### 96 CC

Colonna di scarico con tubo in rame, con piletta "click-clack".



### 96 VA

Colonna di scarico automatico con filo esterno e tubo in rame cm 70, per vasca ad angolo.

100

ACCESSORI PER  
RUBINETTERIA

# CUCINA





# TOUCH-ME



## SIMBOLOGIE:



Canna girevole



Canna alta girevole



Corpo girevole



Touch-Me



Touch-Me Pro



Doccetta estraibile



Con Batterie al Litio Incluse



Utilizzando la tecnologia TOUCH-ME, sviluppata dall'azienda italiana S.T.S.R. - Studio Tecnico Sviluppo e Ricerche, dipartimento di elettronica ([www.stsr.it](http://www.stsr.it)), Remer Rubinetterie presenta una linea di miscelatori con caratteristiche nuove.

Una tecnica brevettata permette di azionare ed interrompere l'erogazione dell'acqua semplicemente toccando il miscelatore. Un piccolo contatto con il dorso della mano, l'avambraccio, il gomito o qualsiasi parte risulti più comoda e funzionale al momento, permette di utilizzare la rubinetteria aprendo e chiudendo l'acqua a piacimento.

Quotidianamente ci troviamo con le mani bagnate, unte, con residui di impasti da cucina o di terra da giardinaggio o sapone per piatti o molti altri esempi ancora.

Varie sono le situazioni in cui con un normale miscelatore dobbiamo forzatamente toccare la maniglia per poterci sciacquare le mani e facendolo sporchiamo il rubinetto che immediatamente per questioni igieniche ci tocca ripulire e lucidare.

Remer Rubinetterie ha pensato di dedicare questo nuovo comfort all'ambiente cucina, luogo in cui la rubinetteria viene usata di frequente e in cui è fondamentale ridurre la presenza di germi e batteri.

Per questo motivo ha integrato la tecnologia TOUCH-ME sui miscelatori per lavello di alta gamma, completando l'eleganza del design e la qualità del prodotto con questa importante funzionalità aggiuntiva.

L'attivazione e la disattivazione del sistema avviene con un semplice tocco. Il contatto con il miscelatore deve avvenire tramite tocco pelle-miscelatore o tramite intercessione di oggetto conduttivo tenuto da una persona. L'erogazione dell'acqua si interrompe automaticamente dopo un periodo di tempo, limitando ulteriormente il contatto con il miscelatore e aumentando la sicurezza di utilizzo. Questa funzione permette un notevole risparmio idrico e colloca il prodotto in una fascia GREEN.



Lo stato del rubinetto aperto non varia se il tocco non è veloce ma stabile. Questa funzione permette di non interferire con lo stato di aperto del miscelatore quindi di gestire comodamente la quantità di acqua e l'impostazione della temperatura nella versione a doppia maniglia e, allo stesso modo, di utilizzare piacevolmente la doccetta estraibile nel modello monocomando e di spostare la bocca girevole in ogni modello.

TOUCH-ME ELEGANT KITCHEN  
CON DISPOSITIVO TOUCH MODELLO PRO PERSONALIZZABILE

TOUCH-ME

COLOR & AMBIENT

ACQUA DEPURATA



**BKT 72 2**

Miscelatore lavello bicomando con tecnologia touch-me e bocca girevole.



**BKT 72**

Miscelatore lavello bicomando con tecnologia touch-me e bocca girevole.



**BKT 74**

Miscelatore lavello bicomando con tecnologia touch-me e bocca girevole.



**NKT 72**

Miscelatore monocomando lavello con tecnologia touch-me con leva laterale e bocca girevole. Dotato di cartuccia Ø25.



**QKT 72**

Miscelatore monocomando lavello con tecnologia touch-me con leva laterale e bocca girevole. Dotato di cartuccia Ø25.



**QKT 72 B**

Miscelatore monocomando lavello con tecnologia touch-me con leva laterale e bocca girevole. Dotato di cartuccia Ø25.

TOUCH-ME INOX



**304T S44**

Miscelatore monocomando per lavello con tecnologia touch-me, cartuccia ad apertura progressiva, completamente in acciaio inox AISI 304, forma minimale quadrata, con bocca alta girevole.



**304T N72**

Miscelatore monocomando per lavello con tecnologia touch-me, completamente in acciaio inox AISI 304, con leva laterale e canna in tubo piegato a U, girevole, forma minimale.

TOUCH-ME GOURMET



**NKT 73**

Miscelatore lavello monocomando con tecnologia touch-me, bocca girevole, base tonda e doccetta estraibile a 2 getti.



**QKT 73**

Miscelatore lavello monocomando con tecnologia touch-me, bocca girevole, base quadrata e doccetta estraibile a 2 getti.

**LT 72**

Miscelatore monocomando lavello, monoforo 90° con canna alta a "U" dotata di tecnologia Touch-Me con leva laterale e bocca girevole. Dotato di cartuccia Ø35.

**LT 72 U**

Miscelatore monocomando lavello, monoforo 90° con canna alta quadra a "U" dotata di tecnologia Touch-Me con leva laterale e bocca girevole. Dotato di cartuccia Ø35.

**LT 72 C**

Miscelatore monocomando lavello, monoforo 90° con canna corta ad "U" dotata di tecnologia Touch-Me con leva laterale e bocca girevole. Dotato di cartuccia Ø35.

**VT 72**

Miscelatore monocomando lavello, monoforo 90° con canna alta ad "U" dotata di tecnologia Touch-Me con leva laterale e bocca girevole. Dotato di cartuccia Ø35.

**VT 72 C**

Miscelatore monocomando lavello, monoforo 90° con canna corta ad "U" dotata di tecnologia Touch-Me con leva laterale e bocca girevole. Dotato di cartuccia Ø35.

**IT 72**

Miscelatore monocomando lavello, monoforo 90° con canna alta ad "U" dotata di tecnologia Touch-Me con leva laterale e bocca girevole. Dotato di cartuccia Ø35.

**WT 72**

Miscelatore monocomando lavello, monoforo 90° con canna alta ad "U" dotata di tecnologia Touch-Me con leva laterale e bocca girevole. Dotato di cartuccia Ø35.

**WT 72 C**

Miscelatore monocomando lavello, monoforo 90° con canna corta ad "U" dotata di tecnologia Touch-Me con leva laterale e bocca girevole. Dotato di cartuccia Ø35.

**WT 72 U**

Miscelatore monocomando lavello, monoforo 90° con canna alta quadra a "U" dotata di tecnologia Touch-Me con leva laterale e bocca girevole. Dotato di cartuccia Ø35.

**DT 72**

Miscelatore monocomando lavello, monoforo 90° con canna alta ad "U" dotata di tecnologia Touch-Me con leva laterale e bocca girevole. Dotato di cartuccia Ø35.

**QT 42 U**

Miscelatore monocomando per lavello, con bocca alta girevole a "U", dotata di tecnologia Touch-Me.

# TOUCH-ME GOURMET COLOR



TOUCH-ME

COLOR & AMBIENT

ACQUA DEPURATA

SIMBOLOGIE:



A



B



C



D



La tecnologia COLOR LED LIGHT è disponibile in quattro varianti denominate A, B, C, D. Per evidenziare la Vostra scelta, aggiungere la lettera corrispondente a fine codice articolo.

## TOUCH-ME COLOR GOURMET CON DISPOSITIVO PRO



**NKTR 73**

Miscelatore lavello monocomando con tecnologia touch-me, bocca girevole, base tonda e doccetta estraibile con luce led.



**QKTR 73**

Miscelatore lavello monocomando con tecnologia touch-me, bocca girevole, base quadrata e doccetta estraibile con luce led.





# COLOR

## SIMBOLOGIE:



Canna alta girevole



Con Luce Led



Doccetta estraibile



Proporzione perfetta.



A



B



C



D



La tecnologia COLOR LED LIGHT è disponibile in quattro varianti denominate A, B, C, D. Per evidenziare la Vostra scelta, aggiungere la lettera corrispondente a fine codice articolo.

## GOURMET DESIGN LIGHT



### QKR 73

Miscelatore lavello monocomando con canna cromata girevole, base quadrata e doccetta con dispositivo led, nei modelli: A, B, C, D.



### QKR 73 N

Miscelatore lavello monocomando con canna nera girevole, base quadrata e doccetta con dispositivo led, nei modelli: A, B, C, D.



### QKR 73 B

Miscelatore lavello monocomando con canna bianca girevole, base quadrata e doccetta con dispositivo led, nei modelli: A, B, C, D.



### NKR 73

Miscelatore lavello monocomando con canna cromata girevole, base tonda e doccetta estraibile con dispositivo led, nei modelli: A, B, C, D.



### NKR 73 N

Miscelatore lavello monocomando con canna nera girevole, base tonda e doccetta estraibile con dispositivo led, nei modelli: A, B, C, D.



### NKR 73 B

Miscelatore lavello monocomando con canna bianca girevole, base tonda e doccetta estraibile con dispositivo led, nei modelli: A, B, C, D.



# AMBIENT

TOUCH-ME

COLOR & AMBIENT

ACQUA DEPURATA

SIMBLOGIE:



Canna alta girevole



Con tecnologia ambient led faucet



Proporzione perfetta.



Alimentato a Corrente Elettrica



## AMBIENT LED FAUCET



QA 40

Monocomando lavello con bocca girevole dotato di dispositivo luminoso AMBIENT.



NA 40

Monocomando lavello con bocca girevole dotato di dispositivo luminoso AMBIENT.



QKA 72

Monocomando lavello bocca girevole, corpo quadrato, dotato di dispositivo luminoso AMBIENT con illuminazione sotto la bocca di erogazione.



NKA 72

Monocomando lavello bocca girevole, corpo tondo, dotato di dispositivo luminoso AMBIENT con illuminazione sotto la bocca di erogazione.

# ACQUA DEPURATA ELETTRONICO



Design e tecnologia acquistano rilievo anche nei modelli dedicati all'acqua depurata.

Due percorsi di ingresso e d'uscita separati dividono l'acqua corrente miscelata dall'acqua filtrata e portano a due aeratori distinti evitando qualsiasi contatto tra i due flussi. Nella versione elettronica, l'erogazione dell'acqua depurata viene comodamente attivata o interrotta con una leggera pressione

dell'apposito pulsante, mentre

la leva di miscelazione regola l'acqua non filtrata secondo la funzionalità tradizionale.

Alla pressione del tasto sono disponibili due temporizzazioni prestabilite a 10 e 20 secondi circa (interrompibili con un'ulteriore pressione).

SIMBOLOGIE:



## RUBINETTO ELETTRONICO ACQUA DEPURATA



**TTEQ 40 DW**

Miscelatore lavello Quadrato a tre vie di ingresso con bocca girevole, con selezione acqua potabile tramite pulsante ad azionamento piezoelettrico alimentato a batteria, con 2 aeratori in uscita.



**TTEN 40 DW**

Miscelatore lavello Minimale a tre vie di ingresso con bocca girevole, con selezione acqua potabile tramite pulsante ad azionamento piezoelettrico alimentato a batteria, con 2 aeratori in uscita.

# ACQUA DEPURATA

**SIMBOLOGIE:**



## ACQUA DEPURATA



**N 40 DW**

Miscelatore lavello Minimale a tre vie di ingresso con bocca girevole, con selezione acqua potabile tramite la leva, con 2 aeratori in uscita.



**Q 40 DW**

Miscelatore lavello Quadrato a tre vie di ingresso con bocca girevole, con selezione acqua potabile tramite la leva, con 2 aeratori in uscita.



**W 79 DW**

Miscelatore lavello serie Winner a tre vie di ingresso con bocca girevole e due vie d'uscita completamente indipendenti, con selezione acqua potabile tramite la leva.



**N 792 DW**

Miscelatore lavello serie Minimal a tre vie di ingresso con bocca girevole e due vie d'uscita completamente indipendenti, con selezione acqua potabile tramite la leva.



**V 79 DW**

Miscelatore lavello serie Vanity a tre vie di ingresso con bocca girevole e due vie d'uscita completamente indipendenti, con selezione acqua potabile tramite la leva.



**I 79 DW**

Miscelatore lavello serie Infinity a tre vie di ingresso con bocca girevole e due vie d'uscita completamente indipendenti, con selezione acqua potabile tramite la leva.



**D 79 DW**

Miscelatore lavello serie Dream a tre vie di ingresso con bocca girevole e due vie d'uscita completamente indipendenti, con selezione acqua potabile tramite la leva.



**L 79 DW**

Miscelatore lavello serie Class Line a tre vie di ingresso con bocca girevole e due vie d'uscita completamente indipendenti, con selezione acqua potabile tramite la leva.

# ELEGANT GOURMET



**SIMBOLOGIE:**



## ELEGANT GOURMET



**SR 501**

Miscelatore lavello con flessibile rivestito in tubo gomma soft-touch nero opaco.



**SR 502**

Miscelatore lavello con flessibile rivestito in tubo gomma soft-touch nero opaco, maniglia verniciata nera opaca.



**SR 503**

Miscelatore lavello con flessibile nero rivestito con molla "fine design".



**SR 505**

Miscelatore lavello con flessibile rivestito in tubo gomma soft-touch bianco opaco.



**SR 506**

Miscelatore lavello con flessibile rivestito in tubo gomma soft-touch bianco opaco, maniglia verniciata bianca opaca.



**SR 504**

Miscelatore lavello con flessibile bianco rivestito con molla "fine design".



**SR 511**

Miscelatore lavello con flessibile rivestito in tubo gomma soft-touch nero opaco.



**SR 512**

Miscelatore lavello con flessibile rivestito in tubo gomma soft-touch nero opaco, maniglia verniciata nera opaca.



**SR 513**

Miscelatore lavello con flessibile nero rivestito con molla "fine design".



**SR 515**

Miscelatore lavello con flessibile rivestito in tubo gomma soft-touch bianco opaco.



**SR 516**

Miscelatore lavello con flessibile rivestito in tubo gomma soft-touch bianco opaco, maniglia verniciata bianca opaca.



**SR 514**

Miscelatore lavello con flessibile bianco rivestito con molla "fine design".



**NK 521**

Miscelatore lavello con flessibile rivestito in tubo gomma soft-touch nero opaco.



**NK 522**

Miscelatore lavello con flessibile rivestito in tubo gomma soft-touch nero opaco, maniglia verniciata nera opaca.

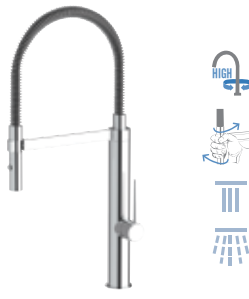

**NK 523**

Miscelatore lavello con flessibile nero rivestito con molla "fine design".



**NK 525**

Miscelatore lavello con flessibile rivestito in tubo gomma soft-touch bianco opaco.



**NK 526**

Miscelatore lavello con flessibile rivestito in tubo gomma soft-touch bianco opaco, maniglia verniciata bianca opaca.



**NK 524**

Miscelatore lavello con flessibile bianco rivestito con molla "fine design".

ELEGANT GOURMET

ELEGANT KITCHEN

CUCINA

GOURMET

GOURMET COLOR

BORDO LAVELLO

304 INOX





**SR 541**  
Miscelatore lavello con flessibile rivestito in tubo gomma soft-touch nero opaco.



**SR 545**  
Miscelatore lavello con flessibile rivestito in tubo gomma soft-touch bianco opaco.



**SR 542**  
Miscelatore lavello con flessibile rivestito in tubo gomma soft-touch nero opaco, maniglia verniciata nera opaca.



**SR 546**  
Miscelatore lavello con flessibile rivestito in tubo gomma soft-touch bianco opaco, maniglia verniciata bianca opaca.



**SR 543**  
Miscelatore lavello con flessibile nero rivestito con molla "fine design".



**SR 544**  
Miscelatore lavello con flessibile bianco rivestito con molla "fine design".



**SR 543 N**  
Miscelatore lavello con flessibile nero rivestito con molla "fine design", corpo principale e maniglia verniciati nero opaco.



**SR 544 B**  
Miscelatore lavello con flessibile bianco rivestito con molla "fine design", corpo principale e maniglia verniciati bianco opaco.





ELEGANT GOURMET

ELEGANT KITCHEN

CUCINA

GOURMET

GOURMET COLOR

BORDO LAVELLO

304 INOX



**Q 501**  
Miscelatore lavello con flessibile rivestito in tubo gomma soft-touch nero opaco.



**Q 505**  
Miscelatore lavello con flessibile rivestito in tubo gomma soft-touch bianco opaco.



**Q 502**  
Miscelatore lavello con flessibile rivestito in tubo gomma soft-touch nero opaco, maniglia verniciata nera opaca.



**Q 506**  
Miscelatore lavello con flessibile rivestito in tubo gomma soft-touch bianco opaco, maniglia verniciata bianca opaca.



**QK 521**  
Miscelatore lavello con flessibile rivestito in tubo gomma soft-touch nero opaco.



**QK 525**  
Miscelatore lavello con flessibile rivestito in tubo gomma soft-touch bianco opaco.



**QK 522**  
Miscelatore lavello con flessibile rivestito in tubo gomma soft-touch nero opaco, maniglia verniciata nera opaca.



**QK 526**  
Miscelatore lavello con flessibile rivestito in tubo gomma soft-touch bianco opaco, maniglia verniciata bianca opaca.

# ELEGANT KITCHEN



## SIMBOLOGIE:



## ELEGANT GOURMET



### QK 73 N

Miscelatore lavello monocomando con canna nera girevole, base quadrata e doccetta a 2 getti.



### QK 73 B

Miscelatore lavello monocomando con canna bianca girevole, base quadrata e doccetta a 2 getti.



### QK 73

Miscelatore lavello monocomando con canna cromata girevole, base quadrata e doccetta a 2 getti.



### NK 73 N

Miscelatore lavello monocomando con canna nera girevole, base tonda e doccetta estraibile a 2 getti.



### NK 73 B

Miscelatore lavello monocomando con canna bianca girevole, base tonda e doccetta estraibile a 2 getti.



### NK 73

Miscelatore lavello monocomando con canna cromata girevole, base tonda e doccetta estraibile a 2 getti.



**NK 72**  
Miscelatore monocomando lavello con leva laterale e bocca girevole. Dotato di cartuccia Ø25.

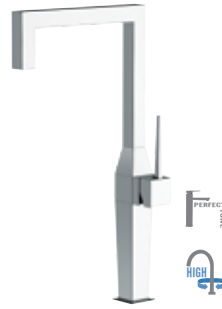

**QK 72**  
Miscelatore monocomando lavello con leva laterale e bocca girevole. Dotato di cartuccia Ø25.

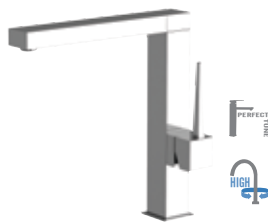

**QK2 72**  
Monocomando lavello bocca girevole, corpo quadrato.



**NK2 72**  
Monocomando lavello bocca girevole, corpo tondo.

ELEGANT GOURMET

ELEGANT KITCHEN

CUCINA

GOURMET

GOURMET COLOR

BORDO LAVELLO

304 INOX



**BK 72 2**  
Miscelatore lavello bicomando con bocca girevole.



**BK 72**  
Miscelatore lavello bicomando con bocca girevole.



**BK 74**  
Miscelatore lavello bicomando con bocca girevole.

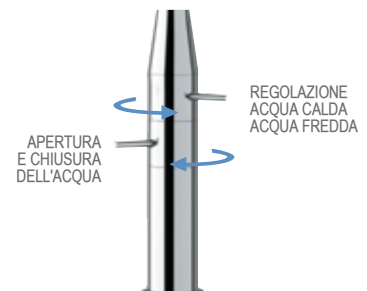

# CUCINA



## SIMBOLOGIE:



Canna girevole



Canna alta girevole



Corpo girevole.



Doccetta estraibile



Proporzione perfetta.



Lavello sottofinestra con canna girevole



Massaggio con getto vigoroso concentrato



Ampio getto pioggia a risparmio idrico



Prodotto novità

## TUTTO CUCINA



**V 72**

Miscelatore monocomando monoforo 90°, con canna alta a "U".



**V 72 C**

Miscelatore monocomando per lavello, con canna corta a "U", tipo lusso.



**V 42 B**

Miscelatore monocomando per lavello, con bocca alta girevole.



**V 42 BC**

Miscelatore monocomando per lavello, con bocca corta girevole.



**I 72**

Miscelatore monocomando monoforo 90°, con canna alta a "U".



**I 72 C**

Miscelatore monocomando per lavello, con bocca alta, modello corto, tipo lusso.



**I 42B**

Miscelatore monocomando per lavello, con bocca alta girevole.



**I 42 BC**

Miscelatore monocomando per lavello, con bocca corta girevole.

# ELEGANZA IN CUCINA



**D 72**  
Miscelatore monocomando monoforo 90°, con canna alta a "U".



**D 72 C**  
Miscelatore monocomando per lavello, con canna corta a "U", tipo lusso.



**D 42 B**  
Miscelatore monocomando per lavello, con bocca alta girevole.



**D 42 BC**  
Miscelatore monocomando per lavello, con bocca corta girevole.



**L 72**  
Miscelatore monocomando monoforo 90°, con canna a "U".



**L 72 C**  
Miscelatore monocomando per lavello, con bocca tipo lusso.



**L 42 B**  
Miscelatore monocomando per lavello, con bocca alta girevole.



**L 42 BC**  
Miscelatore monocomando per lavello, con bocca corta girevole.



**W 72**  
Miscelatore monocomando monoforo 90°, con canna alta a "U".



**W 72 C**  
Miscelatore monocomando per lavello, con canna corta a "U", tipo lusso.



**W 42 B**  
Miscelatore monocomando per lavello, con bocca alta girevole.



**W 42 BC**  
Miscelatore monocomando per lavello, con bocca corta girevole.



**U 42 2**  
Monocomando lavello con bocca alta girevole.



**U 47 2**  
Monocomando lavello con bocca alta girevole e doccetta estraibile.

ELEGANT GOURMET

ELEGANT KITCHEN

CUCINA

GOURMET

GOURMET COLOR

BORDO LAVELLO

304 INOX



**43 LI A**  
Monoforo lavello con canna antica.

## CUCINA COUNTRY

VITONE TRADIZIONALE  
VITONE CERAMICO



**VO**  
VECCHIO OTTONE



**SM**  
OTTONE S. MARCO



**OM**  
V. OTTONE OPACO



**VR**  
VECCHIO RAME



**BR**  
OIL BRONZE

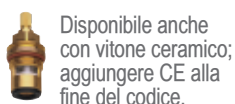

Disponibile anche con vitone ceramico; aggiungere CE alla fine del codice.

# GOURMET



## SIMBOLOGIE:

-   
 Canna girevole
-   
 Canna alta girevole
-   
 Con Luce Led
-   
 Doccetta estraibile
-   
 Doccetta orientabile
-   
 Proporzione perfetta.
-   
 Massaggio con getto vigoroso concentrato
-   
 Getto vigoroso concentrato e getto esterno
-   
 Getto spray delicato ad ampia copertura con getto vigoroso all'esterno a risparmio idrico
-   
 Prodotto novità



### V 77 E

Miscelatore monocomando lavello a molla con doccetta estraibile dal supporto ed orientabile a due funzioni e cartuccia Ø 35.



### I 77 E

Miscelatore monocomando lavello a molla con doccetta estraibile dal supporto ed orientabile a due funzioni e cartuccia Ø 35.



### D 77 E

Miscelatore monocomando lavello a molla con doccetta estraibile dal supporto ed orientabile a due funzioni e cartuccia Ø 35.



ELEGANT GOURMET

ELEGANT KITCHEN

CUCINA

GOURMET

GOURMET COLOR

BORDO LAVELLO

304 INOX



## L 77 E

Miscelatore monocomando lavello a molla con doccetta estraibile dal supporto ed orientabile a due funzioni e cartuccia Ø 35.



## W 77 E

Miscelatore monocomando lavello a molla con doccetta estraibile dal supporto ed orientabile a due funzioni e cartuccia Ø 35.



## N 77 E

Miscelatore monocomando lavello a molla con doccetta estraibile dal supporto ed orientabile a due funzioni e cartuccia Ø 35.



## V 533

Miscelatore lavello monocomando con flessibile nero rivestito con molla "fine design" girevole 360°, con doccetta estraibile dal supporto ed orientabile a due funzioni e cartuccia Ø 35.



## I 533

Miscelatore lavello monocomando con flessibile nero rivestito con molla "fine design" girevole 360°, con doccetta estraibile dal supporto ed orientabile a due funzioni e cartuccia Ø 35.



## D 533

Miscelatore lavello monocomando con flessibile nero rivestito con molla "fine design" girevole 360°, con doccetta estraibile dal supporto ed orientabile a due funzioni e cartuccia Ø 35.



## L 533

Miscelatore lavello monocomando con flessibile nero rivestito con molla "fine design" girevole 360°, con doccetta estraibile dal supporto ed orientabile a due funzioni e cartuccia Ø 35.



## W 533

Miscelatore lavello monocomando con flessibile nero rivestito con molla "fine design" girevole 360°, con doccetta estraibile dal supporto ed orientabile a due funzioni e cartuccia Ø 35.



**Q 73**  
Miscelatore monocomando con base quadrata.



**Q 72**  
Miscelatore monocomando con base quadrata.



**Q 75**  
Miscelatore monocomando con base quadrata.



**Q 82**  
Miscelatore monocomando con base quadrata.



**N 73**  
Miscelatore monocomando con base tonda.



**N 72**  
Miscelatore monocomando con base tonda.



**N 75**  
Miscelatore monocomando con base tonda.



**N 82**  
Miscelatore monocomando con base tonda.



**Q 82 C**  
Miscelatore monocomando con base quadrata.

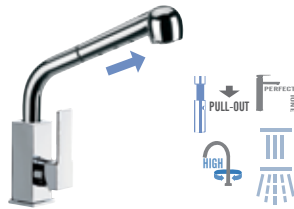

**Q 83 A**  
Miscelatore monocomando con base quadrata.



**Q 83 B**  
Miscelatore monocomando con base quadrata.



**Q 83 C**  
Miscelatore monocomando con base quadrata.

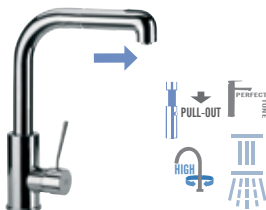

**N 82 C**  
Miscelatore monocomando con base tonda.



**N 83 A**  
Miscelatore monocomando con base tonda.

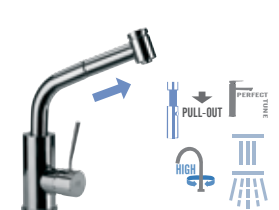

**N 83 B**  
Miscelatore monocomando con base tonda.

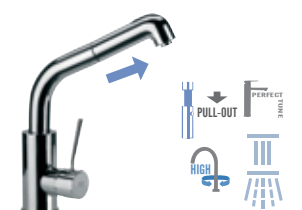

**N 83 C**  
Miscelatore monocomando con base tonda.



**Q 85**  
Miscelatore monocomando con base quadrata.



**N 85**  
Miscelatore monocomando con base tonda.



**Q 86**  
Miscelatore monocomando con base quadrata.



**N 86**  
Miscelatore monocomando con base tonda.

**Varianti Doccette**



**331 DJC**



**331 DJD**

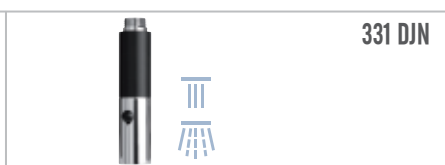

**331 DJN**



**Q 87**  
Miscelatore monocomando con base quadrata.



**Q 77**  
Miscelatore monocomando con base quadrata.



**Q 78**  
Miscelatore monocomando con base quadrata.



**N 87**  
Miscelatore monocomando con base tonda.



**N 77**  
Miscelatore monocomando con base tonda.



**N 78**  
Miscelatore monocomando con base tonda.

ELEGANT GOURMET

ELEGANT KITCHEN

CUCINA

GOURMET

GOURMET COLOR

BORDO LAVELLO

304 INOX

# GOURMET COLOR

## SIMBOLOGIE:



Canna girevole



Canna alta girevole



Con Luce Led



Doccetta estraibile



Proporzione perfetta.



Getto vigoroso concentrato e getto esterno



Prodotto novità

A  B    C     D        

La tecnologia COLOR LED LIGHT è disponibile in quattro varianti denominate A, B, C, D. Per evidenziare la Vostra scelta, aggiungere la lettera corrispondente a fine codice articolo.

La linea Gourmet di Remer Rubinetterie si ispira ai grandi spazi delle cucine professionali, creando un'offerta di miscelatori dal design industriale e fortemente funzionale.

La proposta si articola in numerosi modelli e varianti per soddisfare pienamente ogni esigenza sia di origine progettuale che di semplice gusto personale.

Le bocche alte e ad ampio raggio garantiscono un abbondante spazio di lavoro sotto il miscelatore, permettendo così di maneggiare con comodità anche le stoviglie più ingombranti.

Grazie alle doccette, sia estraibili che con molla a vista, è possibile raggiungere facilmente le zone del lavello più lontane e selezionare il getto d'acqua più adatto all'attività che si sta svolgendo.

I miscelatori della collezione Gourmet si rivolgono ad un utilizzo sia professionale che domestico, rispondendo con qualità, praticità ed estetica alle richieste di una cucina moderna, spaziosa ed elegante.

Immergersi in magiche alternanze cromatiche, amplificare il potere rilassante dell'acqua che scorre e personalizzare con luce e colore gli ambienti di bagno e cucina.

La Cromoterapia è un metodo antichissimo usato per ristabilire equilibri fisici ed emozionali tramite l'irradiazione del colore. Da oggi puoi portare questi effetti positivi anche nei piccoli gesti quotidiani.

I modelli di rubinetteria Remer con tecnologia COLOR LED LIGHT sono dotati di una turbina interna che al semplice passaggio dell'acqua alimenta i led creando colorate e scenografiche atmosfere senza la necessità di alcun tipo di alimentazione elettrica.

Le tecnologia COLOR LED LIGHT è disponibile in quattro diverse varianti tra le quali è possibile scegliere se legare l'alternanza dei colori al cambio della temperatura dell'acqua oppure creare giochi di luce multicolore indipendenti.

Una Terapia Naturale ad Energia Pulita



**NR 77 2**

Miscelatore monocomando con base tonda e doccetta monogetto con luce led.



**NR 75 2**

Miscelatore monocomando con base tonda e doccetta monogetto con luce led.



**NR 75S 2**

Miscelatore monocomando con base tonda e doccetta monogetto con luce led.



**QR 77**

Miscelatore monocomando con base quadrata e doccetta monogetto con luce led.



**QR 75**

Miscelatore monocomando con base quadrata e doccetta monogetto con luce led.



**QR 75S**

Miscelatore monocomando con base quadrata e doccetta monogetto con luce led.

ELEGANT GOURMET

ELEGANT KITCHEN

CUCINA

GOURMET

GOURMET COLOR

BORDO LAVELLO

304 INOX



# BORDO LAVELLO



## SIMBOLOGIE:

  
Canna alta  
girevole

  
Doccetta  
estraibile

  
Con Kit Doccia e  
flessibile lungo:  
120, 150 o 200 cm

  
Doccetta  
Anticalcare

  
Massaggio con  
getto vigoroso  
concentrato

  
Getto vigoroso  
concentrato e  
getto esterno

  
Getto spray delicato  
ad ampia copertura  
con getto vigoroso  
all'esterno a risparmio  
idrico

  
Getto con  
massaggio intenso  
a risparmio idrico

  
Getto  
aerato  
intenso

  
Getto  
Esterno



### N 48 319 MO

Miscelatore monocomando bordo lavello serie Minimal con deviatore a leva integrato nella bocca minimale e doccetta estraibile cromata minimale a 4 funzioni con getti in silicone, idromassaggio ed anticalcare.

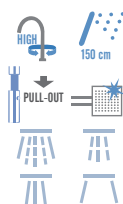

### N 48 332 EU

Miscelatore monocomando bordo lavello serie Minimal con deviatore a leva integrato nella bocca minimale e doccetta estraibile a pulsante minimale in Abs cromata con impugnatura liscia 1/2".

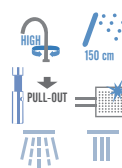





**J 48 319 MO**

Miscelatore monocomando bordo lavello serie Jazz con deviatore a leva integrato nella bocca minimale e doccetta estraibile cromata minimale a 4 funzioni con getti in silicone, idromassaggio ed anticalcare.



**J 48 332 EU**

Miscelatore monocomando bordo lavello serie Jazz con deviatore a leva integrato nella bocca minimale e doccetta estraibile a pulsante minimale in Abs cromata con impugnatura liscia 1/2".



ELEGANT GOURMET

ELEGANT KITCHEN

CUCINA

GOURMET

GOURMET COLOR

BORDO LAVELLO

304 INOX

# 304 INOX



L'acciaio inox è il materiale per eccellenza più adatto al trasporto dell'acqua perché ne mantiene inalterate le caratteristiche fisiologiche e la purezza. Viene utilizzato nelle cucine industriali e nelle industrie

alimentari essendo un materiale di prima scelta. Remer lo propone anche per le abitazioni private come alternativa ancor più valida all'ottone.

## SIMBOLOGIE:

 Proporzioni perfette.

 Canna girevole

 Canna alta girevole

 Con Kit Doccia e flessibile lungo: 120, 150 o 200 cm

 Doccetta estraibile

 Massaggio con getto vigoroso concentrato

 Getto spray delicato ad ampia copertura con getto vigoroso all'esterno a risparmio idrico

 Touch-Me Pro

 Con Batterie al Litio Include



### 304 T47

Miscelatore monocomando livello, completamente in acciaio inox AISI 304, con doccia estraibile a getto variabile.



### 304 N72

Miscelatore monocomando per lavello, completamente in acciaio inox AISI 304, con leva laterale e canna in tubo piegato a U, girevole, forma minimale.



### 304 N77

Miscelatore monocomando laterale per lavello, completamente in acciaio inox AISI 304, alto, con bocca girevole a molla elettrolucidata, flessibile in acciaio inox ricoperto in pvc color argento e doccia a due funzioni in abs cromato. Altezza massima inclusa molla: cm 75. Interasse miscelatore/doccetta: 27 cm.



**304 S44**

Miscelatore monocomando per lavello con cartuccia ad apertura progressiva, completamente in acciaio inox AISI 304, forma minimale quadrata, con bocca alta girevole.



**304 T42**

Miscelatore monocomando per lavello, completamente in acciaio inox AISI 304, con bocca alta girevole tipo lusso.



**304 X43**

Miscelatore tradizionale monoforo maniglia a croce, completamente in acciaio inox AISI 304, con canna alta a C in tubo e girevole.



ELEGANT GOURMET

ELEGANT KITCHEN

CUCINA

## TOUCH-ME



**304T S44**

Miscelatore monocomando per lavello con tecnologia touch-me, cartuccia ad apertura progressiva, completamente in acciaio inox AISI 304, forma minimale quadrata, con bocca alta girevole.



**304T N72**

Miscelatore monocomando per lavello con tecnologia touch-me, completamente in acciaio inox AISI 304, con leva laterale e canna in tubo piegato a U, girevole, forma minimale.



GOURMET

GOURMET COLOR

BORDO LAVELLO

304 INOX

# WELLNESS



# WELLNESS



BOX INCASSO

KIT WELLNESS

CROMOTERAPIA

BRACCI E SOFFIONI

PANNELLI DOCCIA

COLONNE DOCCIA

SALISCENDI

DOCCETTE

SHUT-OFF

KIT BORDO VASCA

BOCCHE

FLESSIBILI DOCCIA

# BOX INCASSO

per miscelatore vasca-doccia con deviatore



- A** Cartuccia Termostatica.
- B** Cartuccia Ø 40.
- C** Cartuccia Ø 35.

Rispetto al tradizionale miscelatore incasso con deviatore, la box incasso Remer presenta diverse caratteristiche aggiuntive che ne fanno un articolo studiato appositamente per le esigenze di cantiere.

Versatile, pratica, funzionale, veloce e sicura nell'installazione, la box da incasso Remer è assolutamente la scelta migliore per dotare il cantiere di una parte murata che nasce per poter poi essere finalizzata in ogni incasso doccia con deviatore Remer, quindi essere abbinata coerentemente con le scelte che l'acquirente finale si riserverà di fare in uno stadio più avanzato dei lavori.

La box è stata appositamente studiata per alloggiare tutte le nostre serie di miscelatori con:

- A) cartuccia termostatica
- B) cartuccia da 40 mm
- C) cartuccia da 35 mm

Quindi, senza più preoccuparsi in anticipo su quale serie e funzionalità possa essere di maggior gradimento ai clienti finali dei vostri cantieri, con la box Remer potrete rendere un servizio migliorativo dando possibilità alla vostra clientela di scegliere in un secondo momento tra le tante varianti di rubinetteria proposte a catalogo Remer.

Con la box incasso potranno quindi essere installate le combinazioni:

- bocca per vasca - saliscendi doccia
- saliscendi doccia - soffione doccia
- bocca per vasca - soffione doccia
- soffione - getti doccia
- saliscendi doccia - getti doccia
- bocca vasca - getti doccia

finalizzate come il cliente richiederà a seguito della scelta estetico funzionale dell'ambiente bagno nel suo insieme, quindi in abbinamento ai miscelatori lavabo bidet etc.

Remer box incasso e tutti i suoi componenti sono interamente prodotti in Italia utilizzando i migliori materiali e tecnologie produttive high-tech.

La materia prima utilizzata per il contenitore della box Remer, ad alta densità, è stata appositamente selezionata per essere pratica al taglio, durevole nel tempo, protettiva, resistente e molto insonorizzante.

Grazie al ridotto spessore della RR BOX è possibile l'installazione in cartongessi e pareti in legno e rimane comunque e sempre un prodotto ispezionabile nel tempo.



## Una volta installata la vostra REMER BOX









Potrete nel tempo scegliere il kit più adatto alle vostre esigenze e ai vostri gusti tra i seguenti kit doccia con deviatore, corrispondenti ciascuno a linee di rubinetteria Remer.

Nel caso in cui il Cliente finale desideri non sfruttare le due uscite è possibile adattare la RRBOX per diventare un incasso non più con deviatore ma a singola uscita.



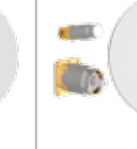



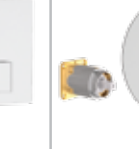
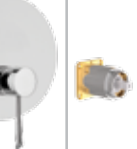
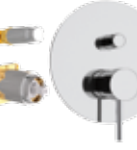
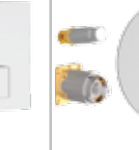
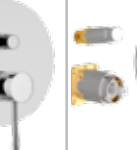
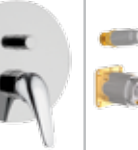



## CARTUCCIA Ø 35

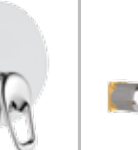

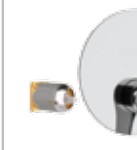
## WELLNESS

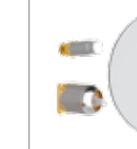
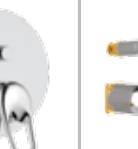
DREAM	INFINITY	ATMOS	CLASS LINE	X STYLE	WINNER	VANITY
 D 30 KB	 I 30 KB	 A 30 KB	 L 30 KB	 X 30 KB	 W 30 KB	 V 30 KB
 D 09 KB	 I 09 KB	 A 09 KB	 L 09 KB	 X 09 KB	 W 09 KB	 V 09 KB
MINIMAL	FLASH	QUBIKA	SQ3	JAZZ	35	REMIX
 N 30 KB	 Z 30 KB	 Q 30 KB	 S 30 3 KB	 J 30 KB	 F 30 KB	 R 30 KB
 N 09 KB	 Z 09 KB	 Q 09 KB	 S 09 3 KB	 J 09 KB	 F 09 KB	 R 09 KB

## CARTUCCIA Ø 40

GIGA 4	KISS	PROJECT	TEN	MUSA
 G 30 4 KB	 K 30 KB	 P 30 KB	 T 30 KB	 M 30 KB
 G 09 4 KB	 K 09 KB	 P 09 KB	 T 09 KB	 M 09 KB

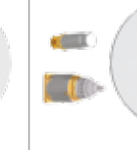
## CARTUCCIA TERMOSTATICA

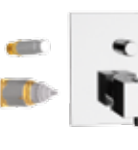
MINIMAL THERMO		QUBIKA THERMO	
 NT 30 KB	 NT 09 KB	 QT 30 KB	 QT 09 KB

- BOX INCASSO
- KIT WELLNESS
- CROMOTERAPIA
- BRACCI E SOFFIONI
- PANNELLI DOCCIA
- COLONNE DOCCIA
- SALISCENDI
- DOCCETTE
- SHUT-OFF
- KIT BORDO VASCA
- BOCCHIE
- FLESSIBILI DOCCIA

# BOX INCASSO

per miscelatore vasca-doccia  
con deviatore a dischi ceramici a 2 o 3 posizioni



Rispetto al tradizionale miscelatore incasso con deviatore, la box incasso Remer presenta diverse caratteristiche aggiuntive che ne fanno un articolo studiato appositamente per le esigenze di cantiere.

Versatile, pratica, funzionale, veloce e sicura nell'installazione, la box da incasso Remer è assolutamente la scelta migliore per dotare il cantiere di una parte murata che nasce per poter poi essere finalizzata in ogni incasso doccia con deviatore Remer, quindi essere abbinata coerentemente con le scelte che l'acquirente finale si riserverà di fare in uno stadio più avanzato dei lavori.

La box è stata appositamente studiata per alloggiare tutte le nostre serie di miscelatori con:

- A) cartuccia termostatica
- B) cartuccia da 40 mm
- C) cartuccia da 35 mm

Quindi, senza più preoccuparsi in anticipo su quale serie e funzionalità possa essere di maggior gradimento ai clienti finali dei vostri cantieri, con la box Remer potrete rendere un servizio migliorativo dando possibilità alla vostra clientela di scegliere in un secondo momento tra le tante varianti di rubinetteria proposte a catalogo Remer.

Con la box incasso con deviatore a dischi ceramici a 2 posizioni potranno essere installate le tutte le combinazioni a due uscite come descritte a pagina 330.

Con la box incasso con deviatore a dischi ceramici a 3 posizioni potranno invece essere installate le seguenti ed altre possibili combinazioni:

- bocca per vasca - saliscendi doccia – soffione doccia
- saliscendi doccia - soffione doccia – funzione cascata del soffione doccia
- bocca per vasca - soffione doccia – funzione cascata del soffione doccia
- soffione - getti doccia - saliscendi
- soffione a pioggia – funzione cascata del soffione doccia - getti
- bocca vasca - getti doccia – saliscendi

finalizzate come il cliente richiederà a seguito della scelta estetico funzionale dell'ambiente bagno nel suo insieme, quindi in abbinamento ai miscelatori lavabo bidet etc.

Remer box incasso e tutti i suoi componenti sono interamente prodotti in Italia utilizzando i migliori materiali e tecnologie produttive high-tech.

La materia prima utilizzata per il contenitore della box Remer, ad alta densità, è stata appositamente selezionata per essere pratica al taglio, durevole nel tempo, protettiva, resistente e molto insonorizzante.

Grazie al ridotto spessore della RR BOX è possibile l'installazione in cartongessi e pareti in legno e rimane comunque e sempre un prodotto ispezionabile nel tempo.









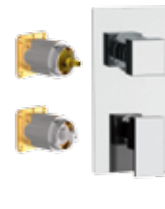

## Una volta installata la vostra REMER BOX

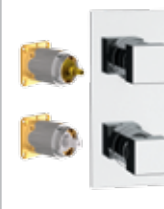

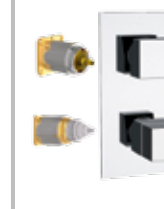

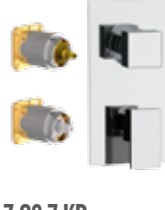
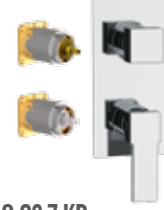
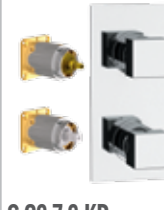
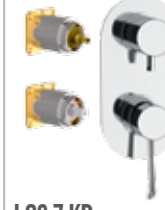



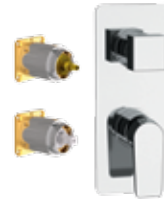

Potrete nel tempo scegliere il kit più adatto alle vostre esigenze e ai vostri gusti tra i seguenti kit doccia con deviatore, corrispondenti ciascuno a linee di rubinetteria Remer.

INCASSI CON RR BOX 93

VANITY	WINNER	DREAM	INFINITY	ATMOS	CLASS LINE	X STYLE
 V 93 KB	 W 93 KB	 D 93 KB	 I 93 KB	 A 93 KB	 L 93 KB	 X 93 KB
 V 93 7 KB	 W 93 7 KB	 D 93 7 KB	 I 93 7 KB	 A 93 7 KB	 L 93 7 KB	 X 93 7 KB

MINIMAL	FLASH	QUBIKA	SQ3	JAZZ	MINIMAL THERMO	QUBIKA THERMO
 N 93 KB	 Z 93 KB	 Q 93 KB	 S 93 3 KB	 J 93 KB	 NT 93 KB	 QT 93 KB
 N 93 7 KB	 Z 93 7 KB	 Q 93 7 KB	 S 93 7 3 KB	 J 93 7 KB	 NT 93 7 KB	 QT 93 7 KB

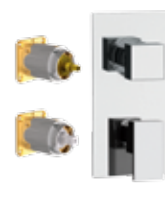
INCASSI CON RR BOX 92

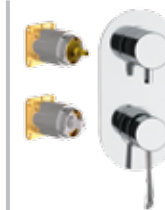
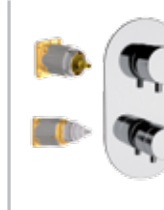
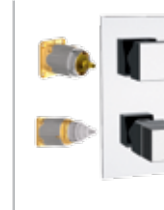
VANITY	WINNER	DREAM	INFINITY	ATMOS	CLASS LINE	X STYLE
 V 92 KB	 W 92 KB	 D 92 KB	 I 92 KB	 A 92 KB	 L 92 KB	 X 92 KB
 N 92 KB	 Z 92 KB	 Q 92 KB	 S 92 3 KB	 J 92 KB	 NT 92 KB	 QT 92 KB

BOX INCASSO  
KIT WELLNESS  
CROMOTERAPIA  
BRACCI E SOFFIONI  
PANNELLI DOCCIA  
COLONNE DOCCIA  
SALISCENDI  
DOCCETTE  
SHUT-OFF  
KIT BORDO VASCA  
BOCCHIE  
FLESSIBILI DOCCIA



# BOX INCASSO

per miscelatore lavabo a parete.



Rispetto al tradizionale miscelatore incasso per lavabo a parete, la box incasso Remer presenta diverse caratteristiche aggiuntive che ne fanno un articolo studiato appositamente per le esigenze di cantiere.

Versatile, pratica, funzionale, veloce e sicura nell'installazione, la box da incasso Remer è assolutamente la scelta migliore per dotare il cantiere di una parte murata che nasce per poter poi essere finalizzata in ogni incasso doccia con deviatore Remer, quindi essere abbinata coerentemente con le scelte che l'acquirente finale si riserverà di fare in uno stadio più avanzato dei lavori.

La box è stata appositamente studiata per alloggiare tutte le nostre serie di miscelatori con dotate di lavabo a parete quindi, senza più preoccuparsi in anticipo su quale serie di miscelatori possa essere di maggior gradimento ai clienti finali dei vostri cantieri, con la box Remer potrete rendere un servizio migliorativo dando possibilità alla vostra clientela di scegliere in un secondo momento tra le tante varianti di rubinetteria proposte a catalogo Remer.

Con la box incasso lavabo a muro potrete poi finalizzare come il cliente richiederà a seguito della scelta estetico funzionale dell'ambiente bagno nel suo insieme, quindi in abbinamento ai miscelatori vasca, doccia, bidet etc.

Remer box incasso e tutti i suoi componenti sono interamente prodotti in Italia utilizzando i migliori materiali e tecnologie produttive high-tech.

La materia prima utilizzata per il contenitore della box Remer, ad alta densità, è stata appositamente selezionata per essere pratica al taglio, durevole nel tempo, protettiva, resistente e molto insonorizzante.

Grazie al ridotto spessore della RR BOX è possibile l'installazione in cartongessi e pareti in legno e rimane comunque e sempre un prodotto ispezionabile nel tempo.



**Cod. RR BOX 15**

Box da incasso per miscelatore doccia due vie.

**Una volta installata la vostra REMER BOX**

Potrete nel tempo scegliere il kit più adatto alle vostre esigenze e ai vostri gusti tra i seguenti kit lavabo a parete, corrispondenti ciascuno a linee di rubinetteria Remer.

<p><b>VANITY</b></p>  <p>V 15 KB</p>	<p><b>INFINITY</b></p>  <p>I 15 KB</p>	<p><b>CLASS LINE</b></p>  <p>L 15 KB</p>
<p><b>WINNER</b></p>  <p>W 15 KB</p>	<p><b>DREAM</b></p>  <p>D 15 KB</p>	<p><b>QUBIKA</b></p>  <p>Q 15 KB</p>
<p><b>SQ3</b></p>  <p>S 15 3 KB</p>	<p><b>MINIMAL</b></p>  <p>N 15 KB</p>	<p><b>X STYLE</b></p>  <p>X 15 KB</p>
<p><b>JAZZ</b></p>  <p>J 15 KB</p>		



# KIT DOCCIA



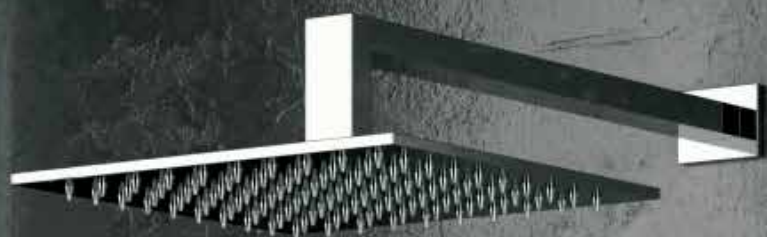

FLESSIBILI  
DOCCIA

BOCCHE

KIT BORDO  
VASCA

SHUT-OFF

DOCCETTE

SALISCENDI

COLONNE  
DOCCIA

PANNELLI  
DOCCIA

BRACCI E  
SOFFIONI

CROMOTERAPIA

KIT WELLNESS

BOX INCASSO

## WELLNESS: KIT WELLNESS

### SIMBOLOGIE:

												
Con Kit Doccia e flessibile lungo: 120, 150 o 200 cm	Termostatico.	Termostatico corpo freddo.	Soffione Anticalcare ed Autopulente	Doccetta Anticalcare	Getti Anticalcare	Pioggia soft a risparmio idrico	Getto aerato intenso	Getto effetto pioggia	Getto ad ampia copertura effetto pioggia	Con getto a cascata	Getto Nebulizzato	Getto Esterno
												
Getto soft aerato miscchiato ad un getto vigoroso a risparmio idrico	Posizione d'interruzione getto	Getto intenso esterno con getto effetto pioggia internamente	Massaggio con getto vigoroso concentrato	Getto con massaggio intenso a risparmio idrico	Massaggio vigoroso ampia copertura effetto pioggia	Getto vigoroso ad ampia copertura effetto pioggia	Massaggio con getto vigoroso ed ampio	Ampio getto pioggia a risparmio idrico	Getto spray delicato ad ampia copertura con getto vigoroso all'esterno a risparmio idrico	Getto vigoroso concentrato e getto esterno		

### VARIANTI FLESSIBILE

Per richiedere la variante flessibile aggiungere la lettera al codice articolo.



#### 332 CN MTR 150

Flessibile doccia retinato realizzato in PVC.

M

+ € 4,30

realizzato in PVC

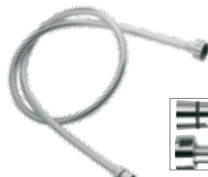

#### 332 CN BC 150

Flessibile doccia in PVC atossico con piattina cromata, attacco conico.

C

+ € 2,70



#### SET S02 D20

Set doccia minimale composto da: braccio doccia da 30 cm, soffione ultra piatto Ø 20 cm in acciaio INOX lucidato a specchio, presa acqua con supporto lusso in ottone cromato, doccetta anticalcare con getti in silicone e flessibile 150 cm.

#### SET S02 D25

Come SET S02 D20 con soffione ultra piatto Ø 25 cm in acciaio INOX lucidato a specchio.



#### SET S02 Q20Q

Set doccia quadrato composto da: braccio doccia da 30 cm, soffione ultra piatto 20x20 cm in acciaio INOX lucidato a specchio, presa acqua con supporto in ottone cromato, doccetta con getti in silicone, anticalcare e flessibile 150 cm.

#### SET S02 Q25Q

Come SET S02 Q20Q con soffione ultra piatto 25x25 cm in acciaio INOX lucidato a specchio.



#### SET S02 UFD20Q

Set doccia composto da: braccio doccia da 30 cm, soffione ultra piatto quadrato con angoli arrotondati 20x20 cm in acciaio INOX, presa acqua con supporto lusso in ottone cromato, doccetta cromata a 3 funzioni e pulsante per il cambio intensità getti, anticalcare con getti in silicone e flessibile 150 cm.

#### SET S02 UFD25Q

Come SET S02 UFD20 con soffione ultra piatto quadrato con angoli arrotondati 25x25 cm in acciaio INOX.



#### SET S02 MD20

Set doccia minimale composto da: braccio doccia da 30 cm, soffione Ø 20 cm in ABS lusso, cromato con 50 getti in silicone autopulenti e anticalcare, presa acqua con supporto lusso in ottone cromato, doccetta anticalcare con getti in silicone e flessibile 150 cm.



#### SET S02 56S0

Set doccia quadrato composto da: braccio doccia da 30 cm, soffione a pioggia, cromo satinato, con 104 getti in silicone anticalcare, a snodo, 23x23 cm, presa acqua con supporto in ottone cromato, doccetta con getti in silicone, anticalcare e flessibile 150 cm.



#### SET S02 AD20Q

Set doccia composto da: braccio doccia da 30 cm, soffione a pioggia squadrato con angoli arrotondati, in ABS cromato, 20x20 cm, con getti anticalcare, presa acqua con supporto lusso in ottone cromato, doccetta cromata a 3 funzioni e pulsante per il cambio intensità getti, anticalcare con getti in silicone e flessibile 150 cm.



## KIT WELLNESS QUADRATI



Set doccia composto da:  
 Art. 357UFD 348N: Soffione doccia ultra piatto in acciaio INOX lucidato a specchio con braccio in ottone.  
 Art. 315R 319MO con 333CN150: Saliscendi cromato con asta tonda minimale e doccetta cromata minimale a 4 funzioni con getti in silicone, idromassaggio ed anticalcare e flessibile conico in ottone cromato.  
 Art. 309 L: presa acqua tipo rotondo pesante.  
 Art. D 09: Miscelatore incasso con deviatore.



CODICE	DESCRIZIONE
D 09 S01 UFD20	Con 357UFD20: Soffione doccia ultra piatto 20x20 cm, braccio doccia 30 cm.
D 09 S01 UFD25	Con 357UFD25: Soffione doccia ultra piatto 25x25 cm, braccio doccia 30 cm.
D 09 S01 UFD30	Con 357UFD30: Soffione doccia ultra piatto 30x30 cm, braccio doccia 30 cm.
D 09 S01 UFD40	Con 357UFD40: Soffione doccia ultra piatto 40x40 cm, braccio doccia 40 cm.



Set doccia composto da:  
 Art. 357UFD 348N: Soffione doccia ultra piatto in acciaio INOX lucidato a specchio con braccio in ottone.  
 Art. 339N 319MO con 333CN150: doccetta cromata minimale a 4 funzioni con getti in silicone, idromassaggio ed anticalcare, supporto snodato a braccio minimale in abs cromato e flessibile conico in ottone cromato.  
 Art. 309 L: presa acqua tipo rotondo pesante.  
 Art. D 09: Miscelatore incasso con deviatore.



CODICE	DESCRIZIONE
D 09 S02 UFD20	Con 357UFD20: Soffione doccia ultra piatto 20x20 cm, braccio doccia 30 cm.
D 09 S02 UFD25	Con 357UFD25: Soffione doccia ultra piatto 25x25 cm, braccio doccia 30 cm.
D 09 S02 UFD30	Con 357UFD30: Soffione doccia ultra piatto 30x30 cm, braccio doccia 30 cm.
D 09 S02 UFD40	Con 357UFD40: Soffione doccia ultra piatto 40x40 cm, braccio doccia 40 cm.

BOX INCASSO

KIT WELLNESS

CROMOTERAPIA

BRACCI E SOFFIONI

PANNELLI DOCCIA

COLONNE DOCCIA

SALISCENDI

DOCCETTE

SHUT-OFF

KIT BORDO VASCA

BOCCHE

FLESSIBILI DOCCIA



**I09 S01**

Set doccia composto da:  
 Art. 348S 354Q): soffione doccia cm 20x20 quadrato con angoli arrotondati ultrapiatto in abs cromato, e getti anticalcare con braccio quadrato in ottone cm 30.  
 Art. I09: Monocomando vasca/doccia incasso con deviatore.  
 Art. 317V 317RV 333CN 150: saliscendi cromato con asta minimale ovale dritta, doccetta anticalcare e flessibile conico in ottone cromato cm 150.  
 Art. 309S: presa acqua quadrata in ottone cromato.



**I09 S02**

Set doccia composto da:  
 Art. 348S 354Q): soffione doccia cm 20x20 quadrato con angoli arrotondati ultrapiatto in abs cromato, e getti anticalcare con braccio quadrato in ottone cm 30.  
 Art. I09: Monocomando vasca/doccia incasso con deviatore.  
 Art. 339SOS: supporto fisso quadrato in ottone cromato per flessibile con attacco conico.  
 Art. 317RV 333CN 150: doccetta cromata minimale ovale anticalcare con flessibile conico in ottone cromato cm 150.  
 Art. 309S: presa acqua quadrata in ottone cromato.



**I09 S01 UFD20**

Set doccia composto da:  
 Art. 348S 357UFD: soffione doccia cm 20x20 quadrato con angoli arrotondati ultrapiatto in acciaio INOX lucidato a specchio, e getti anticalcare con braccio quadrato in ottone cm 30.  
 Art. I09: Monocomando vasca/doccia incasso con deviatore.  
 Art. 317V 317RV 333CN 150: saliscendi cromato con asta minimale ovale dritta, doccetta anticalcare e flessibile conico in ottone cromato cm 150.  
 Art. 309S: presa acqua quadrata in ottone cromato.



**V09 S01**

Set doccia composto da:  
 Art. 348N30 356AD20: soffione doccia cm 20x20 quadrato con angoli arrotondati in abs cromato, e getti anticalcare con braccio minimale in ottone cm 30.  
 Art. V09: Monocomando vasca/doccia incasso con deviatore.  
 Art. 317V 315P3 333CNX 150: saliscendi cromato con asta minimale ovale dritta, doccetta cromata a 4 funzioni, pulsante per cambio getti, anticalcare e flessibile conico in ottone cromato cm 150.  
 Art. 309L: presa acqua rotonda in ottone cromato.

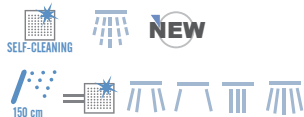

**V09 S02**

Set doccia composto da:  
 Art. 348N30 356AD20: soffione doccia cm 20x20 quadrato con angoli arrotondati in abs cromato, e getti anticalcare con braccio minimale in ottone cm 30.  
 Art. V09: Monocomando vasca/doccia incasso con deviatore.  
 Art. 315P3 333CNX 150: doccetta cromata a 4 funzioni, pulsante per cambio getti, anticalcare con flessibile conico in ottone cromato cm 150.  
 Art. 337M: presa acqua e supporto in ottone cromato per flessibile con attacco conico.



**S09 3 S02**

Set doccia composto da:  
 Art. 359SS 348S30: Soffione SQ in ottone cromato 20x20 cm anticalcare con braccio quadro in ottone cm 30.  
 Art. 337S: Supporto doccia deluxe duplex con presa acqua in ottone cromato.  
 Art. 317SS con 333CN150: con doccetta in ottone cromato anticalcare e flessibile conico in ottone cromato cm 150.  
 Art. S09 3: Miscelatore incasso con deviatore.



**S93 7 3 S01**

Set doccia composto da:  
 Art. 359SS 348S30: Soffione SQ in ottone cromato 20x20 cm anticalcare con braccio quadro in ottone cm 30.  
 Art. 317S 317SS: Saliscendi quadro con doccetta in ottone cromato e flessibile conico in ottone cromato.  
 Art. 309S: Presa acqua Q in ottone cromato.  
 Art. Q 34 JET: 6 getti anticalcare Q in ottone cromato.  
 Art. S93 7 3: Miscelatore incasso con deviatore a tre vie e sette posizioni su piastra unica.







## S 93 7 3 S02

Set doccia composto da:  
 Art. 359SS 348S30: Soffione SQ in ottone cromato 20x20 cm anticalcare con braccio quadro in ottone cm 30.  
 Art. 337 S: Supporto doccia deluxe duplex con presa acqua.  
 Art. 317SS con 333CN 150: con doccetta in ottone cromato anticalcare e flessibile conico in ottone cromato cm 150.  
 Art. Q 34 JET: 6 getti anticalcare Q in ottone cromato.  
 Art. S 93 7 3: Miscelatore incasso con deviatore a tre vie e sette posizioni su piastra unica.



## S 93 7 3 S03

Set doccia composto da:  
 Art. 359SS 348S30: Soffione SQ in ottone cromato 20x20 cm anticalcare con braccio quadro in ottone cm 30.  
 Art. 337 S: Supporto doccia deluxe duplex con presa acqua.  
 Art. 317SS con 333CN 150: con doccetta in ottone cromato anticalcare e flessibile conico in ottone cromato cm 150.  
 Art. 91 S : Bocca incasso serie S.  
 Art. S 93 7 3: Miscelatore incasso con deviatore a tre vie e sette posizioni su piastra unica.



Set doccia composto da:  
 Art. 357UFS 348Q: Soffione doccia ultra piatto in acciaio INOX lucidato a specchio con braccio doccia Q in ottone cromato.  
 Art. 317R 317RR: Saliscendi e doccetta tutto ottone serie ultrapiatta rettangolare minimale lusso con flessibile 333CN150 cm 150.  
 Art. 309 S: Presa acqua lusso quadrata.  
 Art. Q 09: Miscelatore incasso con deviatore.



Set doccia composto da:  
 Art. 357UFS 348Q: Soffione doccia ultra piatto in acciaio INOX lucidato a specchio con braccio doccia Q in ottone cromato.  
 Art. 337S: Supporto doccia deluxe duplex con presa acqua.  
 Art. 317RR con 333CN150 con doccetta ultrapiatta e flessibile conico in ottone cromato cm 150.  
 Art. Q 09: Miscelatore incasso con deviatore



ARTICOLO	DESCRIZIONE
Q 09 S01 UFS20	Con art. 357UFS20: 20x20 cm soffione doccia ultra piatto, con braccio doccia 30 cm.
Q 09 S01 UFS25	Con art. 357UFS25: 25x25 cm soffione doccia ultra piatto con braccio doccia 30 cm.
Q 09 S01 UFS30	Con art. 357UFS30: 30x30 cm soffione doccia ultra piatto con braccio doccia 30 cm.
Q 09 S01 UFS40	Con art. 357UFS40: 40x40 cm soffione doccia ultra piatto con braccio doccia 40 cm.

ARTICOLO	DESCRIZIONE
Q 09 S02 UFS20	Con art. 357UFS20: 20x20 cm soffione doccia ultra piatto con braccio doccia 30 cm.
Q 09 S02 UFS25	Con art. 357UFS25: 25x25 cm soffione doccia ultra piatto con braccio doccia 30 cm.
Q 09 S02 UFS30	Con art. 357UFS30: 30x30 cm soffione doccia ultra piatto con braccio doccia 30 cm.
Q 09 S02 UFS40	Con art. 357UFS40: 40x40 cm soffione doccia ultra piatto con braccio doccia 40 cm.



## Q 09 S21 UFS20

Set doccia composto da:  
 Art. 357UFS20 347S 30: Soffione doccia ultra piatto in acciaio INOX lucidato a specchio con braccio doccia a soffitto in ottone cromato, cm 30.  
 Art. 317R 317RR: Saliscendi e doccetta tutto ottone serie ultrapiatta rettangolare minimale lusso con flessibile 333CN150 cm 150.  
 Art. 309 S: Presa acqua lusso quadrata.  
 Art. Q 09: Miscelatore incasso con deviatore.



## Q 09 S22 UFS20

Set doccia composto da:  
 Art. 357UFS20 347S 30: Soffione doccia ultra piatto in acciaio INOX lucidato a specchio con braccio doccia a soffitto in ottone cromato, cm 30.  
 Art. 337S: Supporto doccia deluxe duplex con presa acqua.  
 Art. 317RR con 333CN150 con doccetta ultrapiatta e flessibile conico in ottone cromato cm 150.  
 Art. Q 09: Miscelatore incasso con deviatore.



BOX INCASSO

KIT WELLNESS

CROMOTERAPIA

BRACCI E SOFFIONI

PANNELLI DOCCIA

COLONNE DOCCIA

SALISCENDI

DOCCETTE

SHUT-OFF

KIT BORDO VASCA

BOCCHIE

FLESSIBILI DOCCIA



**Q 93 7 S01 SSSCA**

Set doccia composto da:  
 Art. 350 SS CA: Soffione doccia a parete in acciaio INOX lucidato a specchio, 2 getti, pioggia e cascata.  
 Art. 317R 317RR: Saliscendi e doccetta tutto ottone serie ultrapiatta rettangolare minimale lusso con flessibile 333CN150 cm 150.  
 Art. 309 S: Presa acqua lusso quadrata.  
 Art. Q 93 7: Miscelatore monocomando per doccia con deviatore a tre vie e 7 posizioni su piastra unica.



**Q 09 S01 SS**

Set doccia composto da:  
 Art. 350 SS: Soffione doccia a parete in acciaio INOX lucidato a specchio, getto pioggia.  
 Art. 317R 317RR: Saliscendi e doccetta tutto ottone serie ultrapiatta rettangolare minimale lusso con flessibile 333CN150 cm 150.  
 Art. 309 S: Presa acqua lusso quadrata.  
 Art. Q 09: Miscelatore incasso con deviatore.



**Q 93 7 S02 SSSCA**

Set doccia composto da:  
 Art. 350 SS CA: Soffione doccia a parete in acciaio INOX lucidato a specchio, 2 getti, pioggia e cascata.  
 Art. 337S: Supporto doccia deluxe duplex con presa acqua.  
 Art. 317RR con 333CN150 con doccetta ultrapiatta e flessibile conico in ottone cromato cm 150.  
 Art. Q 93 7: Miscelatore monocomando per doccia con deviatore a tre vie e 7 posizioni su piastra unica.



**Q 09 S02 SS**

Set doccia composto da:  
 Art. 350 SS: Soffione doccia a parete in acciaio INOX lucidato a specchio, getto pioggia.  
 Art. 337S: Supporto doccia deluxe duplex con presa acqua.  
 Art. 317RR con 333CN150 con doccetta ultrapiatta e flessibile conico in ottone cromato cm 150.  
 Art. Q 09: Miscelatore incasso con deviatore.



**Q93 7 S21 UFS20**

Set doccia composto da:  
 Art. 357UFS20 347S 30: Soffione doccia ultra piatto in acciaio INOX lucidato a specchio 20x20 cm con braccio a soffitto doccia in ottone cromato, cm 30.  
 Art. 317R 317RR: Saliscendi e doccetta tutto ottone serie ultrapiatta rettangolare minimale lusso con flessibile 333CN150 cm 150.  
 Art. 309 S: Presa acqua lusso quadrata.  
 Art. Q 93 7: Miscelatore incasso con deviatore a tre vie e sette posizioni su piastra unica.  
 Art. Q 34 JET: 6 getti anticalcare Q in ottone cromato.



**Q93 7 S22 UFS20**

Set doccia composto da:  
 Art. 357UFS20 347S30: Soffione doccia ultra piatto in acciaio INOX lucidato a specchio 20x20 cm, con braccio doccia a soffitto in ottone cromato, cm 30.  
 Art. 337S: Supporto doccia deluxe duplex con presa acqua.  
 Art. 317RR con 333CN150 con doccetta ultrapiatta e flessibile conico in ottone cromato cm 150.  
 Art. Q 93 7: Miscelatore incasso con deviatore a tre vie e sette posizioni su piastra unica.  
 Art. Q 34 JET: 6 getti anticalcare Q in ottone cromato.







Set doccia composto da:  
 Art. 357UFS 348Q: Soffione doccia ultra piatto in acciaio INOX lucidato a specchio con Braccio doccia Q in ottone cromato.  
 Art. 317R 317RR: Saliscendi e doccetta tutto ottone serie ultrapiatta rettangolare minimale lusso con flessibile 333CN150 cm 150.  
 Art. 309 S: Presa acqua lusso quadrata.  
 Art. Q 93 7: Miscelatore incasso con deviatore a tre vie e sette posizioni su piastra unica.  
 Art. Q 34 JET: 6 getti anticalcare Q in ottone cromato.



ARTICOLO	DESCRIZIONE
Q93 7 S01 UFS20	Con art. 357UFS20: 20x20 cm soffione doccia ultra piatto, con braccio doccia 30 cm.
Q93 7 S01 UFS25	Con art. 357UFS25: 25x25 cm soffione doccia ultra piatto, con braccio doccia 30 cm.
Q93 7 S01 UFS30	Con art. 357UFS30: 30x30 cm soffione doccia ultra piatto, con braccio doccia 30 cm.
Q93 7 S01 UFS40	Con art. 357UFS40: 40x40 cm soffione doccia ultra piatto, con braccio doccia 40 cm.



Set doccia composto da:  
 Art. 357UFS 348Q: Soffione doccia ultra piatto in acciaio INOX lucidato a specchio con Braccio doccia Q in ottone cromato.  
 Art. 337S: Supporto doccia deluxe duplex con presa acqua.  
 Art. 317RR con 333CN150 con doccetta ultrapiatta e flessibile conico in ottone cromato cm 150.  
 Art. Q 93 7: Miscelatore incasso con deviatore a tre vie e sette posizioni su piastra unica.  
 Art. Q 34 JET: 6 getti anticalcare Q in ottone cromato.



ARTICOLO	DESCRIZIONE
Q93 7 S02 UFS20	Con art. 357UFS20: 20x20 cm soffione doccia ultra piatto, con braccio doccia 30 cm.
Q93 7 S02 UFS25	Con art. 357UFS25: 25x25 cm soffione doccia ultra piatto, con braccio doccia 30 cm.
Q93 7 S02 UFS30	Con art. 357UFS30: 30x30 cm soffione doccia ultra piatto, con braccio doccia 30 cm.
Q93 7 S02 UFS40	Con art. 357UFS40: 40x40 cm soffione doccia ultra piatto, con braccio doccia 40 cm.



**Q 94 S01 SSCA**  
 Set doccia composto da:  
 Art. 350 SS CA: Soffione doccia a parete in acciaio INOX lucidato a specchio, 2 getti, pioggia e cascata.  
 Art. 317R 317RR: Saliscendi e doccetta tutto ottone serie ultrapiatta rettangolare minimale lusso con flessibile 333CN150 cm 150.  
 Art. 309 S: Presa acqua lusso quadrata.  
 Art. Q 94: Miscelatore monocomando per doccia con deviatore a 4 posizioni (4 uscite ed 1 entrata) su piastra unica.  
 Art. Q 34 JET: 6 getti anticalcare Q in ottone cromato.



**Q 93 7 S01 SS**  
 Set doccia composto da:  
 Art. 350 SS: Soffione doccia a parete in acciaio INOX lucidato a specchio, getto pioggia.  
 Art. 317R 317RR: Saliscendi e doccetta tutto ottone serie ultrapiatta rettangolare minimale lusso con flessibile 333CN150 cm 150.  
 Art. 309 S: Presa acqua lusso quadrata.  
 Art. Q 93 7: Miscelatore monocomando per doccia con deviatore a tre vie e sette posizioni su piastra unica.  
 Art. Q 34 JET: 6 getti anticalcare Q in ottone cromato.



**Q 94 S02 SSCA**  
 Set doccia composto da:  
 Art. 350 SS CA: Soffione doccia a parete in acciaio INOX lucidato a specchio, 2 getti, pioggia e cascata.  
 Art. 337S: Supporto doccia deluxe duplex con presa acqua.  
 Art. 317RR con 333CN150 con doccetta ultrapiatta e flessibile conico in ottone cromato cm 150.  
 Art. Q 94: Miscelatore monocomando per doccia con deviatore a tre vie e sette posizioni su piastra unica.  
 Art. Q 34 JET: 6 getti anticalcare Q in ottone cromato.



**Q 93 7 S02 SS**  
 Set doccia composto da:  
 Art. 350 SS: Soffione doccia a parete in acciaio INOX lucidato a specchio, getto pioggia.  
 Art. 337S: Supporto doccia deluxe duplex con presa acqua.  
 Art. 317RR con 333CN150 con doccetta ultrapiatta e flessibile conico in ottone cromato cm 150.  
 Art. Q 93 7: Miscelatore monocomando per doccia con deviatore a tre vie e sette posizioni su piastra unica.  
 Art. Q 34 JET: 6 getti anticalcare Q in ottone cromato.



BOX INCASSO

KIT WELLNESS

CROMOTERAPIA

BRACCI E SOFFIONI

PANNELLI DOCCIA

COLONNE DOCCIA

SALISCENDI

DOCCETTE

SHUT-OFF

KIT BORDO VASCA

BOCCHIE

FLESSIBILI DOCCIA



Set doccia composto da:  
 Art. 359SS: Soffione SQ in ottone anticalcare 20x20 cm.  
 Braccio doccia quadrato in ottone cromato, cm 30.  
 Art. 317S 317SQ: Saliscendi quadro con doccetta Q anticalcare e flessibile conico in ottone cromato cm 150.  
 Art. 309S: Presa acqua Q in ottone cromato.  
 Art. Q 09: Miscelatore incasso con deviatore.



ARTICOLO	DESCRIZIONE
Q 09 S01	Con art. 348S: braccio doccia a parete quadrato in ottone cromato, lunghezza 30 cm.
Q 09 S21	Con art. 347S: braccio doccia a soffito quadrato in ottone cromato, lunghezza 30 cm.



Set doccia composto da:  
 Art. 359SS: Soffione SQ in ottone anticalcare 20x20 cm.  
 Braccio doccia quadrato in ottone cromato, cm 30.  
 Art. 337S: Supporto doccia deluxe duplex con presa acqua.  
 Art. 317SQ con 333CN150 con doccetta Q anticalcare e flessibile conico in ottone cromato cm 150.  
 Art. Q 09: Miscelatore incasso con deviatore.



ARTICOLO	DESCRIZIONE
Q 09 S02	Con art. 348S: braccio doccia a parete quadrato in ottone cromato, lunghezza 30 cm.
Q 09 S22	Con art. 347S: braccio doccia a soffito quadrato in ottone cromato, lunghezza 30 cm.



Set doccia composto da:  
 Art. 359SS: Soffione SQ in ottone anticalcare 20x20 cm.  
 Braccio doccia quadrato in ottone cromato, cm 30.  
 Art. 317S 317SQ: saliscendi Q in ottone cromato con doccetta Q anticalcare e flessibile conico in ottone cromato cm 150.  
 Art. 309S: Presa acqua Q in ottone cromato.  
 Art. Q 34 JET: 6 getti anticalcare Q in ottone cromato.  
 Art. Q 93 7: Miscelatore incasso con deviatore a tre vie e sette posizioni su piastra unica.



ARTICOLO	DESCRIZIONE
Q 93 7 S01	Con art. 348S: braccio doccia a parete quadrato in ottone cromato, lunghezza 30 cm.
Q 93 7 S21	Con art. 347S: braccio doccia a soffito quadrato in ottone cromato, lunghezza 30 cm.



Set doccia composto da:  
 Art. 359SS 348S: Soffione SQ in ottone anticalcare 20x20 cm.  
 Braccio doccia quadrato in ottone cromato, cm 30.  
 Art. 337 S: Supporto doccia deluxe duplex con presa acqua.  
 Art. 317SQ con 333CN 150: con doccetta Q anticalcare e flessibile conico in ottone cromato cm 150.  
 Art. Q 34 JET: 6 getti anticalcare Q in ottone cromato.  
 Art. Q 93 7: Miscelatore incasso con deviatore a tre vie e sette posizioni su piastra unica.



ARTICOLO	DESCRIZIONE
Q 93 7 S02	Con art. 348S: braccio doccia a parete quadrato in ottone cromato, lunghezza 30 cm.
Q 93 7 S22	Con art. 347S: braccio doccia a soffito quadrato in ottone cromato, lunghezza 30 cm.



Set doccia composto da:  
 Art. 359SS: Soffione SQ in ottone anticalcare 20x20 cm.  
 Braccio doccia quadrato in ottone cromato, cm 30.  
 Art. 339S 317SQ con 333CN 150: Supporto doccia cromato con doccetta Q anticalcare e flessibile conico in ottone cromato cm 150.  
 Art. 91 QD: Bocca incasso Q con deviatore.  
 Art. Q 09: Miscelatore incasso con deviatore.



ARTICOLO	DESCRIZIONE
Q 09 S03	Con art. 348S: braccio doccia a parete quadrato in ottone cromato, lunghezza 30 cm.
Q 09 S23	Con art. 347S: braccio doccia a soffito quadrato in ottone cromato, lunghezza 30 cm.



**Q 30 S11**

Set doccia composto da:  
 Art. 330S 359 SS 317SQ 333CN 150: Colonna doccia a barra quadrata, deluxe, con deviatore e saliscendi, soffione doccia quadrato in ottone con getti in silicone anticalcare, doccetta serie Qubika anticalcare, flessibile doccia conico in ottone.  
 Art. 330S RA: Presa acqua-attacco a muro quadrato.  
 Art. Q 30: Miscelatore incasso doccia Qubika.





## QC 93 7 S33

Set doccia composto da:  
 Art. 359 ZC: Soffione doccia con getto a cascata.  
 Art. 317SQ 337S: Set doccia duplex anticalcare SQ con presa acqua.  
 Art. 91 QC: Bocca incasso a cascata serie QC.  
 Art. Q 93 7: Miscelatore monocomando per doccia con deviatore a tre vie e sette posizioni su unica piastra



Set doccia composto da:  
 Art. 359SS: soffione anticalcare a pioggia rettangolare completamente in ottone 20x20 cm.  
 Braccio doccia quadrato in ottone cromato, cm 30.  
 Art. 317SQ 337S: Set doccia duplex anticalcare SQ con presa acqua.  
 Art. 91 QC: Bocca incasso a cascata serie QC.  
 Art. Q 93 7: Miscelatore monocomando per doccia con deviatore a tre vie e sette posizioni su unica piastra

CODICE	DESCRIZIONE
QC 93 7 S03	Con art. 348S: braccio doccia a parete quadrato in ottone cromato, lunghezza 30 cm.
QC 93 7 S23	Con art. 347S: braccio doccia a soffitto quadrato in ottone cromato, lunghezza 30 cm.



## QC 94 S03 UFCA

Set doccia composto da:  
 Art. 350UFCA: soffione doccia ultrapiatto 50x25 cm, a parete in acciaio INOX lucidato a specchio, 2 getti, pioggia e cascata.  
 Art. 317SQ 337S: Set doccia duplex anticalcare SQ con presa acqua.  
 Art. 91 QC: Bocca incasso a cascata serie QC.  
 Art. Q 94: Miscelatore monocomando per doccia con deviatore a quattro posizioni su piastra unica.



## QC 94 S03 SSCA

Set doccia composto da:  
 Art. 350 SS CA: Soffione doccia a parete in acciaio INOX lucidato a specchio 50x20 cm, 2 getti, pioggia e cascata.  
 Art. 317SQ 337S: Set doccia duplex anticalcare SQ con presa acqua.  
 Art. 91 QC: Bocca incasso a cascata serie QC.  
 Art. Q 94: Miscelatore monocomando per doccia con deviatore a quattro posizioni su piastra unica.



## QC 95 S04 UFCA

Set doccia composto da:  
 Art. 350UFCA: soffione ultrapiatto doccia 50x25 cm, a parete in acciaio INOX lucidato a specchio, 2 getti, pioggia e cascata.  
 Art. 317S 317SQ: Saliscendi quadro con doccetta Q anticalcare e flessibile conico in ottone cromato.  
 Art. 309 S: Presa acqua lusso quadrata.  
 Art. 91 QC: Bocca incasso a cascata serie QC.  
 Art. Q34 JET: 6 getti anticalcare SQ in ottone cromato.  
 Art. Q 95: Miscelatore monocomando per doccia, con deviatore a 5 posizioni su piastra singola.



## QC 95 S04 SSCA

Set doccia composto da:  
 Art. 350 SS CA: Soffione doccia a parete in acciaio INOX lucidato a specchio 50x20 cm, 2 getti, pioggia e cascata.  
 Art. 317S 317SQ: Saliscendi quadro con doccetta Q anticalcare e flessibile conico in ottone cromato.  
 Art. 309 S: Presa acqua lusso quadrata.  
 Art. 91 QC: Bocca incasso a cascata serie QC.  
 Art. Q34 JET: 6 getti anticalcare SQ in ottone cromato.  
 Art. Q 95: Miscelatore monocomando per doccia, con deviatore a 5 posizioni su piastra singola.



BOX INCASSO

KIT WELLNESS  
CROMOTERAPIA

BRACCI E SOFFIONI

PANNELLI DOCCIA

COLONNE DOCCIA

SALISCENDI

DOCCETTE

SHUT-OFF

KIT BORDO VASCA

BOCCHE

FLESSIBILI DOCCIA



### Z 93 7 S01 UFCA

Set doccia composto da:  
 Art. 350 UF CA: Soffione doccia ultrapiatto 50x25 cm, a parete in acciaio INOX lucidato a specchio, 2 getti, pioggia e cascata.  
 Art. 317R 317RR: Saliscendi e doccetta tutto in ottone cromato, serie ultrapiatta rettangolare minimale lusso coN flessibile 333CN cm 150.  
 Art. Z 93 7: Miscelatore monocomando per doccia con deviatore a tre vie e sette posizioni su piastra unica.  
 Art. 309S: Presa acqua quadrata in ottone cromato.



### Z 09 S01 UF

Set doccia composto da:  
 Art. 350 UF: Soffione doccia ultrapiatto 50x25 cm, a parete in acciaio INOX lucidato a specchio, 1 getto pioggia.  
 Art. 317R 317RR: Saliscendi e doccetta tutto in ottone cromato, serie ultrapiatta rettangolare minimale lusso coN flessibile 333CN cm 150.  
 Art. Z 09: Miscelatore monocomando da incasso con deviatore per vasca/doccia.  
 Art. 309S: Presa acqua quadrata in ottone cromato.



### Z 93 7 S02 UFCA

Set doccia composto da:  
 Art. 350 UF CA: Soffione doccia ultrapiatto 50x25 cm, a parete in acciaio INOX lucidato a specchio, 2 getti, pioggia e cascata.  
 Art. 337S 317RR 333CN150: Presa acqua deluxe in ottone cromato, doccetta flat in ottone cromato e flessibile doccia conico in ottone cromato.  
 Art. Z 93 7: Miscelatore monocomando per doccia con deviatore a tre vie e sette posizioni su piastra unica.



### Z 09 S02 UF

Set doccia composto da:  
 Art. 350 UF: Soffione doccia ultrapiatto 50x25 cm, a parete in acciaio INOX lucidato a specchio, 1 getto pioggia.  
 Art. 337S 317RR 333CN150: Presa acqua deluxe in ottone cromato, doccetta flat in ottone cromato e flessibile doccia conico in ottone cromato.  
 Art. Z 09: Miscelatore monocomando da incasso con deviatore per vasca/doccia.



### Z 09 S02

Set doccia composto da:  
 Art. 359 ZC: Soffione doccia con getto a cascata completamente in ottone cromato.  
 Art. 337S 317RR 333CN150: Presa acqua deluxe in ottone cromato, doccetta flat in ottone cromato e flessibile doccia conico in ottone cromato.  
 Art. Z 09: Miscelatore monocomando incasso per doccia con deviatore.



### Z 93 7 S01

Set doccia composto da:  
 Art. 359 ZC: Soffione doccia con getto a cascata completamente in ottone cromato.  
 Art. Q 34 JET: 6 getti Q idromassaggio anticalcare.  
 Art. 317R 317RR: Saliscendi e doccetta tutto in ottone cromato, serie ultrapiatta rettangolare minimale lusso coN flessibile 333CN cm 150.  
 Z 93 7: Miscelatore monocomando incasso con deviatore a tre vie e sette posizioni su piastra unica.  
 Art. 309S: Presa acqua quadrata in ottone cromato.



### Z 93 7 S02

Set doccia composto da:  
 Art. 359 ZC: Soffione doccia con getto a cascata completamente in ottone cromato.  
 Art. Q 34 JET: 6 getti Q idromassaggio anticalcare.  
 Art. 337S 317RR 333CN150: Presa acqua con supporto doccia duplex, doccetta flat e flessibile conico cm 150 il tutto in ottone cromato.  
 Z 93 7: Miscelatore monocomando incasso con deviatore a tre vie e sette posizioni su piastra unica.



### Z 93 7 S03

Set doccia composto da:  
 Art. 359 ZC: Soffione doccia con getto a cascata completamente in ottone cromato.  
 Art. 337S 317RR 333CN150: Presa acqua con supporto doccia duplex, doccetta flat e flessibile conico cm 150 il tutto in ottone cromato.  
 Z 93 7: Miscelatore monocomando incasso con deviatore a tre vie e sette posizioni su piastra unica.  
 Art. 91 ZC: bocca incasso con getto a cascata completamente in ottone cromato.







BOX INCASSO

KIT WELLNESS

CROMOTERAPIA

BRACCI E SOFFIONI

PANNELLI DOCCIA

COLONNE DOCCIA

SALISCENDI

DOCCETTE

SHUT-OFF

KIT BORDO VASCA

BOCCHIE

FLESSIBILI DOCCIA

## KIT WELLNESS TONDI



### A 09 S02

Art. 348N30 + 359MM30: braccio doccia in ottone cromato con soffione minimale in ottone cromato anticalcare Ø 30.  
 Art. 317TH 339: doccetta Torch in abs cromato con supporto snodato e flessibile conico in ottone cromato cm 150.  
 Art. 309 L: presa acqua deluxe in ottone cromato.  
 Art. A 09: Miscelatore incasso doccia con deviatore.



### A 09 S07

Art. 348N30 + 359MM30: braccio doccia in ottone cromato con soffione minimale in ottone cromato anticalcare Ø 30.  
 Art. 310M 317TH: saliscendi con doccetta Torch e flessibile conico in ottone cromato cm 150.  
 Art. 309 L: presa acqua deluxe in ottone cromato.  
 Art. A 09: Miscelatore incasso doccia con deviatore.



### L 09 S01

Set doccia composto da:  
 Art. 356MD20 348N30: soffione minimale in abs lusso Ø 20 cm cromato con braccio in ottone cm 30.  
 Art. L 09L: Monocomando vasca/doccia incasso con deviatore con piastra lusso.  
 Art. 317M 319MO: saliscendi minimale con doccetta anticalcare a 4 funzioni.  
 Art. 309L: presa acqua pesante e flessibile doccia cm 150.



### L 09 S02

Set doccia composto da:  
 Art. 356MD20 348N30: soffione minimale in abs lusso Ø 20 cm cromato con braccio in ottone cm 30.  
 Art. L 09L: Monocomando vasca/doccia incasso con deviatore, piastra lusso.  
 Art. 319MO 337M: doccia duplex anticalcare a 4 funzioni con supporto presa acqua in ottone cromato e flessibile conico cm 150.



### L 09 S01 UFM20

Set doccia composto da:  
 Art. 357UFM20 348N30: soffione minimale ultrapiatto in acciaio INOX lucidato a specchio Ø 20 cm con braccio in ottone cm 30.  
 Art. L 09L: Monocomando vasca/doccia incasso con deviatore, piastra lusso.  
 Art. 317M 319MO: saliscendi minimale con doccetta anticalcare a 4 funzioni.  
 Art. 309L: presa acqua pesante e flessibile doccia cm 150.



**W 09 S02 EC20**

Set composto da: miscelatore monocomando da incasso con deviatore per vasca/doccia W09, presa acqua e supporto doccia in ottone cromato 337M con doccetta anticalcare ed idromassaggio con getti in silicone a 4 funzioni 319MO e flessibile 333CNX; braccio doccia in ottone cromato e rosetta cm 30 art. 343 e soffione a pioggia in ABS cromato Ø20 cm con getti anticalcare art. 354EC20.



**W 09 S01 EC20**

Set composto da: miscelatore monocomando da incasso con deviatore per vasca/doccia W09, saliscendi cromato con asta tonda, con doccetta anticalcare ed idromassaggio con getti in silicone a 4 funzioni 315R 319MO, presa acqua 309L e flessibile in acciaio inox; braccio doccia in ottone cromato e rosetta cm 30 art. 343 e soffione a pioggia in ABS cromato Ø20 cm con getti anticalcare art. 354EC20.



**W 09 S01 UFM20**

Set composto da: miscelatore monocomando da incasso con deviatore per vasca/doccia W09, saliscendi cromato con asta tonda, con doccetta anticalcare ed idromassaggio con getti in silicone a 4 funzioni 317M 319MO, presa acqua 309L e flessibile in acciaio inox; braccio doccia in ottone cromato e rosetta cm 30 art. 348N30 e soffione a pioggia in acciaio INOX, ultrapiatto, lucidato a specchio, Ø20 cm con getti anticalcare art. 357UFM20.



**X 09 S01**

Set doccia composto da:  
Art. 357UFM20 348N 30: Soffione doccia ultra piatto Ø20 in acciaio INOX lucidato a specchio con braccio in ottone cm 30.  
Art. 317M 317MM con 333CN150: Saliscendi minimale con doccetta Minimal completamente in ottone cromato e flessibile conico in ottone cromato.  
Art. 309 L: presa acqua tipo rotondo pesante.  
Art. X 09 L: Miscelatore incasso con deviatore e piastra lusso.



**X 09 S02**

Set doccia composto da:  
Art. 357UFM20 348N 30: Soffione doccia ultra piatto Ø20 in acciaio INOX lucidato a specchio con braccio in ottone cm 30.  
Art. 337M 317MM con 333CN150: doccetta Minimal completamente in ottone cromato con supporto presa acqua e flessibile conico in ottone cromato cm 150.  
Art. X 09 L: Miscelatore incasso con deviatore e piastra lusso.



**X 96 S02**

Set doccia composto da:  
Art. 357UFM20 348N30: Soffione doccia ultra piatto Ø 20 cm in acciaio INOX lucidato a specchio con braccio in ottone cm 30.  
Art. X 96: Miscelatore e deviatore su piastre separate.  
Art. 337X 317MM con 333CN150: doccetta Minimal completamente in ottone cromato con supporto presa acqua e flessibile conico in ottone cromato cm 150.







Set doccia composto da:  
 Art. 357UFM 348N: Soffione doccia ultra piatto in acciaio INOX lucidato a specchio con braccio in ottone cromato.  
 Art. 317M 317MM con 333CN150: Saliscendi minimale con doccetta Minimal completamente in ottone cromato e flessibile conico in ottone cromato.  
 Art. 309 L: presa acqua tipo rotondo pesante.  
 Art. N 09 L: Miscelatore incasso con deviatore e piastra lusso.



ARTICOLO	DESCRIZIONE
N 09 S01 UFM20	Con 357UFM20: Soffione doccia ultra piatto Ø20 cm, con braccio 30 cm.
N 09 S01 UFM25	Con 357UFM25: Soffione doccia ultra piatto Ø25 cm, con braccio 30 cm.
N 09 S01 UFM30	Con 357UFM30: Soffione doccia ultra piatto Ø30 cm, con braccio 30 cm.
N 09 S01 UFM40	Con 357UFM40: Soffione doccia ultra piatto Ø40 cm, con braccio 40 cm.



Set doccia composto da:  
 Art. 357UFM 348N: Soffione doccia ultra piatto in acciaio INOX lucidato a specchio con braccio in ottone cromato.  
 Art. 317M 317MM con 333CN150: Saliscendi minimale con doccetta Minimal completamente in ottone cromato e flessibile conico in ottone cromato.  
 Art. 309 L: presa acqua tipo rotondo pesante.  
 Art. N 93 7: miscelatore monocomando per doccia con deviatore a tre vie e sette posizioni su unica piastra.  
 Art. N 34 JET: 6 getti minimali anticalcare in ottone cromato.



ARTICOLO	DESCRIZIONE
N 93 7 S02 UFM20	Con 357UFM20: Soffione doccia ultra piatto Ø20 cm, con braccio 30 cm.
N 93 7 S02 UFM25	Con 357UFM25: Soffione doccia ultra piatto Ø25 cm, con braccio 30 cm.
N 93 7 S02 UFM30	Con 357UFM30: Soffione doccia ultra piatto Ø30 cm, con braccio 30 cm.
N 93 7 S02 UFM40	Con 357UFM40: Soffione doccia ultra piatto Ø40 cm, con braccio 40 cm.



Set doccia composto da:  
 Art. 357UFM 348N: Soffione doccia ultra piatto in acciaio INOX lucidato a specchio con braccio in ottone cromato.  
 Art. 337M 317MM con 333CN150: Doccia duplex Minimal completamente in ottone cromato con supporto presa acqua e flessibile conico in ottone cromato cm 150.  
 Art. N 09 L: Miscelatore incasso con deviatore e piastra lusso.



ARTICOLO	DESCRIZIONE
N 09 S02 UFM20	Con 357UFM20: Soffione doccia ultra piatto Ø20 cm, con braccio 30 cm.
N 09 S02 UFM25	Con 357UFM25: Soffione doccia ultra piatto Ø25 cm, con braccio 30 cm.
N 09 S02 UFM30	Con 357UFM30: Soffione doccia ultra piatto Ø30 cm, con braccio 30 cm.
N 09 S02 UFM40	Con 357UFM40: Soffione doccia ultra piatto Ø40 cm, con braccio 40 cm.



Set doccia composto da:  
 Art. 357UFM 348N: Soffione doccia ultra piatto in acciaio INOX lucidato a specchio con braccio in ottone cromato.  
 Art. 337M 317MM con 333CN150: Doccia duplex Minimal completamente in ottone cromato con supporto presa acqua e flessibile conico in ottone cromato cm 150.  
 Art. N 93 7: miscelatore monocomando per doccia con deviatore a tre vie e sette posizioni su unica piastra.  
 Art. N 34 JET: 6 getti minimali anticalcare in ottone cromato.



ARTICOLO	DESCRIZIONE
N 93 7 S01 UFM20	Con 357UFM20: Soffione doccia ultra piatto Ø20 cm, con braccio 30 cm.
N 93 7 S01 UFM25	Con 357UFM25: Soffione doccia ultra piatto Ø25 cm, con braccio 30 cm.
N 93 7 S01 UFM30	Con 357UFM30: Soffione doccia ultra piatto Ø30 cm, con braccio 30 cm.
N 93 7 S01 UFM40	Con 357UFM40: Soffione doccia ultra piatto Ø40 cm, con braccio 40 cm.

BOX INCASSO

KIT WELLNESS

CROMOTERAPIA

BRACCI E SOFFIONI

PANNELLI DOCCIA

COLONNE DOCCIA

SALISCENDI

DOCCETTE

SHUT-OFF

KIT BORDO VASCA

BOCCHE

FLESSIBILI DOCCIA

### N 94 S01 UFMCA

Set doccia composto da:  
 Art. 350UFMCA: Soffione doccia ultrapiatto 50x25 cm, a parete in acciaio INOX lucidato a specchio, 2 getti, normale o cascata.  
 Art. 317M 317MM con 333CN150: Saliscendi minimale con doccetta Minimal completamente in ottone cromato e flessibile conico in ottone cromato.  
 Art. 309 L: presa acqua tipo rotondo pesante.  
 Art. N 94: miscelatore monocomando per doccia con deviatore a 4 posizioni su piastra unica.  
 Art. N 34 JET: 6 getti minimali anticalcare in ottone cromato.



### N 93 7 S01 UFM

Set doccia composto da:  
 Art. 350UFM: Soffione doccia ultrapiatto 50x25 cm, a parete in acciaio INOX lucidato a specchio, getto a pioggia.  
 Art. 317M 317MM con 333CN150: Saliscendi minimale con doccetta Minimal completamente in ottone cromato e flessibile conico in ottone cromato.  
 Art. 309 L: presa acqua tipo rotondo pesante.  
 Art. N 937: miscelatore monocomando per doccia con deviatore a 3 vie e 7 posizioni su piastra unica.  
 Art. N 34 JET: 6 getti minimali anticalcare in ottone cromato.



### N 937 S01 UFMCA

Set doccia composto da:  
 Art. 350UFMCA: Soffione doccia ultrapiatto 50x25 cm, a parete in acciaio INOX lucidato a specchio, 2 getti, normale o cascata.  
 Art. 317M 317MM con 333CN150: Saliscendi minimale con doccetta Minimal completamente in ottone cromato e flessibile conico in ottone cromato.  
 Art. 309 L: presa acqua tipo rotondo pesante.  
 Art. N 93 7: miscelatore monocomando per doccia con deviatore a tre vie e sette posizioni su unica piastra.



### N 09 S01 UFM

Set doccia composto da:  
 Art. 350UFM: Soffione doccia ultrapiatto 50x25 cm, a parete in acciaio INOX lucidato a specchio, getto a pioggia.  
 Art. 317M 317MM con 333CN150: Saliscendi minimale con doccetta Minimal completamente in ottone cromato e flessibile conico in ottone cromato.  
 Art. 309 L: presa acqua tipo rotondo pesante.  
 Art. N 09 L: Miscelatore incasso con deviatore e piastra lusso.



### N 94 S02 UFMCA

Set doccia composto da:  
 Art. 350UFMCA: Soffione doccia ultrapiatto 50x25 cm, a parete in acciaio INOX lucidato a specchio, 2 getti, normale o cascata.  
 Art. 337M 317MM con 333CN150: Doccia duplex Minimal completamente in ottone cromato con supporto presa acqua e flessibile conico in ottone cromato cm 150.  
 Art. N 94: miscelatore monocomando per doccia con deviatore a 4 posizioni su piastra unica.  
 Art. N 34 JET: 6 getti minimali anticalcare in ottone cromato.



### N 937 S02 UFM

Set doccia composto da:  
 Art. 350UFM: Soffione doccia ultrapiatto 50x25 cm, a parete in acciaio INOX lucidato a specchio, getto a pioggia.  
 Art. 337M 317MM con 333CN150: Doccia duplex Minimal completamente in ottone cromato con supporto presa acqua e flessibile conico in ottone cromato cm 150.  
 Art. N 93 7: miscelatore monocomando per doccia con deviatore a tre vie e sette posizioni su unica piastra.  
 Art. N 34 JET: 6 getti minimali anticalcare in ottone cromato.



### N 93 7 S02 UFMCA

Set doccia composto da:  
 Art. 350UFMCA: Soffione doccia ultrapiatto 50x25 cm, a parete in acciaio INOX lucidato a specchio, 2 getti, normale o cascata.  
 Art. 337M 317MM con 333CN150: Doccia duplex Minimal completamente in ottone cromato con supporto presa acqua e flessibile conico in ottone cromato cm 150.  
 Art. N 93 7: miscelatore monocomando per doccia con deviatore a tre vie e sette posizioni su unica piastra.



### N 09 S02 UFM

Set doccia composto da:  
 Art. 350UFM: Soffione doccia ultrapiatto 50x25 cm, a parete in acciaio INOX lucidato a specchio, getto a pioggia.  
 Art. 337M 317MM con 333CN150: Doccia duplex Minimal completamente in ottone cromato con supporto presa acqua e flessibile conico in ottone cromato cm 150.  
 Art. N 09 L: Miscelatore incasso con deviatore e piastra lusso.





## N 09 S01

Set doccia composto da:  
 Art. 356LU 348N 30: Soffione minimale anticalcare con braccio in ottone cm 30.  
 Art. 317M 317DM con 333CN 150: Saliscendi minimale con doccetta anticalcare e flessibile conico in ottone cromato.  
 Art. 309 L: presa acqua tipo rotondo pesante.  
 Art. N 09 L: Miscelatore incasso con deviatore e piastra lusso.



## N 93 7 S02

Set doccia composto da:  
 Art. 359MM30 348N 30: soffione minimale anticalcare in ottone Ø 30, con braccio in ottone cm 30.  
 Art. 317G 321HG con 333CN 150: Saliscendi in ottone cromato e doccetta minimale a 3 funzioni con getti in silicone e flessibile conico in ottone cromato cm 150.  
 Art. 309 L: presa acqua tipo rotondo pesante.  
 Art. N 34 JET: 6 getti minimali anticalcare in ottone cromato.  
 Art. N 93 7: miscelatore monocomando per doccia con deviatore a tre vie e sette posizioni su unica piastra.



## N 09 S03

Set doccia composto da:  
 Art. 356LU 348N 30: Soffione minimale anticalcare con braccio in ottone cm 30.  
 Art. 339N 317DM con 333CN 150: Doccia duplex minimale anticalcare con supporto duplex e flessibile conico in ottone cromato cm 150.  
 Art. 91 MD: Bocca incasso Minimal con deviatore integrato.  
 Art. N 09 L: Miscelatore incasso con deviatore e piastra lusso



## N 93 7 S01

Set doccia composto da:  
 Art. 359MM30 348N 30: soffione minimale anticalcare in ottone Ø 30, con braccio in ottone cm 30.  
 Art. 337M 321HG con 333CN 150: Doccetta a 3 funzioni, con getti in silicone, supporto doccia duplex in ottone cromato con presa acqua e flessibile conico in ottone cromato cm 150.  
 Art. N34JET: 6 getti minimali anticalcare in ottone cromato.  
 Art. N 93 7: miscelatore monocomando per doccia con deviatore a tre vie e sette posizioni su unica piastra.



## N 09 S11

Set doccia composto da:  
 Art. 330U 356LU 317DM 330RA con 333CN 150: Colonna doccia deluxe girevole con deviatore e saliscendi, completa di soffione doccia cromato anticalcare, doccetta minimale, flessibile doccia e supporto presa acqua per colonna.  
 Art. N 09 L: Miscelatore monocomando incasso con deviatore e piastra lusso.  
 Art. 91M: Bocca incasso Minimale.

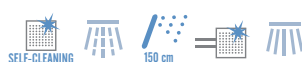

## N 09 S02

Set doccia composto da:  
 Art. 356LU 348N 30: Soffione minimale anticalcare con braccio in ottone cm 30.  
 Art. 337M 317DM con 333CN 150: Doccia duplex minimale anticalcare con supporto presa acqua e flessibile conico in ottone cromato cm 150.  
 Art. N 09 L: Miscelatore incasso con deviatore e piastra lusso.



BOX INCASSO

KIT WELLNESS

CROMOTERAPIA

BRACCI E SOFFIONI

PANNELLI DOCCIA

COLONNE DOCCIA

SALISCENDI

DOCCETTE

SHUT-OFF

KIT BORDO VASCA

BOCCHIE

FLESSIBILI DOCCIA



## KIT WELLNESS TERMOSTATICI QUADRATI



### QT 93 7 S01 SSCA

Set doccia composto da:  
 Art. 350SSCA soffione doccia a parete 50x20cm, in acciaio INOX lucidato specchio, 2 getti, pioggia e cascata.  
 Art. 317S 317SQ: Saliscendi quadro con doccetta Q anticalcare e flessibile conico in ottone cromato cm 150.  
 Art. 309 S: Presa acqua lusso quadrata.  
 Art. QT 93 7 miscelatore incasso termostatico monocomando per doccia con deviatore a tre vie e 7 posizioni su piastra unica.



### QT 09 S01 SS

Set doccia composto da:  
 Art. 350SS soffione doccia a parete 50x20cm, in acciaio INOX lucidato a specchio.  
 Art. 317S 317SQ: Saliscendi quadro con doccetta Q anticalcare e flessibile conico in ottone cromato cm 150.  
 Art. 309 S: Presa acqua lusso quadrata.  
 Art. QT 09: Miscelatore incasso termostatico con deviatore.



### QT 93 7 S02 SSCA

Set doccia composto da:  
 Art. 350SSCA soffione doccia a parete 50x20cm, in acciaio INOX lucidato specchio, 2 getti, pioggia e cascata.  
 Art. 337S: Supporto doccia deluxe duplex con presa acqua.  
 Art. 317SQ con 333CN150 con doccetta Q anticalcare e flessibile conico in ottone cromato cm 150.  
 Art. QT 93 7 miscelatore incasso termostatico monocomando per doccia con deviatore a tre vie e 7 posizioni su piastra unica.



### QT 09 S02 SS

Set doccia composto da:  
 Art. 350SS soffione doccia a parete 50x20cm, in acciaio INOX lucidato a specchio.  
 Art. 337S: Supporto doccia deluxe duplex con presa acqua.  
 Art. 317SQ con 333CN150 con doccetta Q anticalcare e flessibile conico in ottone cromato cm 150.  
 Art. QT 09: Miscelatore incasso termostatico con deviatore.







## QT 93 7 S03 SSSCA

Set doccia composto da:  
 Art. 350SSCA soffione doccia a parete 50x20cm, in acciaio INOX lucidato aspecchio, 2 getti, pioggia e cascata.  
 Art. 337S 317SQ con 333CN 150: Supporto doccia cromato con doccetta Q anticalcare e flessibile conico in ottone cromato cm 150.  
 Art. 91 Q: Bocca incasso Q.  
 Art. QT 93 7 miscelatore incasso termostatico monocomando per doccia con deviatore a tre vie e 7 posizioni su piastra unica.



## QT 09 S03 SS

Set doccia composto da:  
 Art. 350SS soffione doccia a parete 50x20cm, in acciaio INOX lucidato a specchio.  
 Art. 339S 317SQ con 333CN 150: Supporto doccia cromato con doccetta Q anticalcare e flessibile conico in ottone cromato cm 150.  
 Art. 91 QD: Bocca incasso Q con deviatore.  
 Art. QT 09: Miscelatore incasso termostatico con deviatore.



## QT 09 S02

Set doccia composto da:  
 Art. 359SS 348S30: Soffione SQ in ottone anticalcare con braccio quadro in ottone cm 30.  
 Art. 337S: Supporto doccia deluxe duplex con presa acqua.  
 Art. 317SQ con 333CN150 con doccetta Q anticalcare e flessibile conico in ottone cromato cm 150.  
 Art. QT 09: Miscelatore incasso termostatico con deviatore.



## QT 09 S01

Set doccia composto da:  
 Art. 359SS 348S 30: Soffione SQ in ottone anticalcare con braccio quadro in ottone cm 30.  
 Art. 317S 317SQ: Saliscendi quadro con doccetta Q anticalcare e flessibile conico in ottone cromato cm 150.  
 Art. 309 S: Presa acqua lusso quadrata.  
 Art. QT 09: Miscelatore incasso termostatico con deviatore.



## QT 09 S03

Set doccia composto da:  
 Art. 359SS 348S30: Soffione SQ in ottone anticalcare con braccio quadro in ottone cm 30.  
 Art. 339S 317SQ con 333CN 150: Supporto doccia cromato con doccetta Q anticalcare e flessibile conico in ottone cromato cm 150.  
 Art. 91 QD: Bocca incasso Q con deviatore.  
 Art. QT 09: Miscelatore incasso termostatico con deviatore.



## QT 93 7 S01

Set doccia composto da:  
 Art. 359SS 348S30: Soffione SQ in ottone anticalcare con braccio quadro in ottone cm 30.  
 Art. 317S 317SQ: saliscendi Q in ottone cromato con doccetta Q anticalcare e flessibile conico in ottone cromato cm 150.  
 Art. 309S: Presa acqua Q in ottone cromato.  
 Art. Q 34 JET: 6 getti anticalcare Q in ottone cromato.  
 Art. QT 93 7: Miscelatore incasso termostatico con deviatore a tre vie e sette posizioni su piastra unica.



BOX INCASSO

KIT WELLNESS

CROMOTERAPIA

BRACCI E SOFFIONI

PANNELLI DOCCIA

COLONNE DOCCIA

SALISCENDI

DOCCETTE

SHUT-OFF

KIT BORDO VASCA

BOCCHIE

FLESSIBILI DOCCIA

## WELLNESS: KIT WELLNESS

### QT 93 7 S02

Set doccia composto da:  
 Art. 359SS 348S30: Soffione SQ in ottone anticalcare con braccio quadro in ottone cm 30.  
 Art. 337 S: Supporto doccia deluxe duplex con presa acqua.  
 Art. 317SQ con 333CN 150: con doccetta Q anticalcare e flessibile conico in ottone cromato cm 150.  
 Art. Q 34 JET: 6 getti anticalcare Q in ottone cromato.  
 Art. QT 93 7: Miscelatore incasso termostatico con deviatore a tre vie e sette posizioni su piastra unica.



### QT 93 7 S03

Set doccia composto da:  
 Art. 359SS 348S30: Soffione SQ in ottone anticalcare con braccio quadro in ottone cm 30.  
 Art. 337 S: Supporto doccia deluxe duplex con presa acqua.  
 Art. 317SQ con 333CN 150: con doccetta Q anticalcare e flessibile conico in ottone cromato cm 150.  
 Art. 91 Q: Bocca incasso serie Q.  
 Art. QT 93 7: Miscelatore incasso termostatico con deviatore a tre vie e sette posizioni su piastra unica.



### QT 30 S11

Set doccia composto da:  
 Art. 330S 359 SS 317SQ 333CN 150: Colonna doccia a barra quadrata, deluxe, con deviatore e saliscendi, soffione doccia quadrato in ottone con getti in silicone anticalcare, doccetta serie Qubika anticalcare, flessibile doccia conico in ottone.  
 Art. 330SRA: Presa acqua/attacco a muro quadrato.  
 Art. QT 30: Miscelatore incasso termostatico doccia Qubika.







Set doccia composto da:

Art. 359SS: soffione anticalcare a pioggia rettangolare completamente in ottone 20x20 cm. Braccio doccia quadrato in ottone cromato, cm 30.  
Art. 317 SQ 337S: Set doccia duplex anticalcare SQ con presa acqua.  
Art. 91 QC: Bocca incasso a cascata serie QC.  
Art. QT 93 7 miscelatore incasso termostatico monocomando per doccia con deviatore a tre vie e 7 posizioni su piastra unica.



## QTC 93 7 S33

Set doccia composto da:

Art. 359 ZC: Soffione doccia con getto a cascata.  
Art. 317 SQ 337S: Set doccia duplex anticalcare SQ con presa acqua.  
Art. 91 QC: Bocca incasso a cascata serie QC.  
Art. QT 93 7: miscelatore incasso termostatico monocomando per doccia con deviatore a tre vie e 7 posizioni su piastra unica.

CODICE	DESCRIZIONE
QTC 937 S03	Con art. 348S: braccio doccia a parete quadrato in ottone cromato, lunghezza 30 cm.
QTC 937 S23	Con art. 347S: braccio doccia a soffitto quadrato in ottone cromato, lunghezza 30 cm.



## QTC 94 S03 UFCA

Set doccia composto da:

Art. 350UFCA: soffione doccia ultrapiatto 50x25 cm, a parete in acciaio INOX lucidato a specchio, 2 getti, pioggia e cascata.  
Art. 317SQ 337S: Set doccia duplex anticalcare SQ con presa acqua.  
Art. 91 QC: Bocca incasso a cascata serie QC.  
Art. QT 94: Miscelatore monocomando incasso termostatico per doccia con deviatore a quattro posizioni su piastra unica.



## QTC 94 S03 SSSCA

Set doccia composto da:

Art. 350 SS CA: Soffione doccia a parete in acciaio INOX lucidato a specchio 50x20 cm, 2 getti, pioggia e cascata.  
Art. 317SQ 337S: Set doccia duplex anticalcare SQ con presa acqua.  
Art. 91 QC: Bocca incasso a cascata serie QC.  
Art. QT 94: Miscelatore monocomando incasso termostatico per doccia con deviatore a quattro posizioni su piastra unica.



## QTC 95 S04 UFCA

Set doccia composto da:

Art. 350UFCA: soffione doccia ultrapiatto 50x25 cm, a parete in acciaio INOX lucidato a specchio, 2 getti, pioggia e cascata.  
Art. 317S 317SQ: Saliscendi quadro con doccetta Q anticalcare e flessibile conico in ottone cromato.  
Art. 309 S: Presa acqua lusso quadrata.  
Art. 91 QC: Bocca incasso a cascata serie QC.  
Art. Q34 JET: 6 getti anticalcare SQ in ottone cromato.  
Art. QT 95: Miscelatore monocomando incasso termostatico per doccia, con deviatore a 5 posizioni su piastra singola.

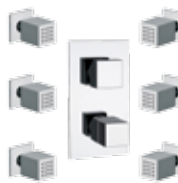

## QTC 95 S04 SSSCA

Set doccia composto da:

Art. 350 SS CA: Soffione doccia a parete in acciaio INOX lucidato a specchio 50x20 cm, 2 getti, pioggia e cascata.  
Art. 317S 317SQ: Saliscendi quadro con doccetta Q anticalcare e flessibile conico in ottone cromato.  
Art. 309 S: Presa acqua lusso quadrata.  
Art. 91 QC: Bocca incasso a cascata serie QC.  
Art. Q34 JET: 6 getti anticalcare SQ in ottone cromato.  
Art. QT 95: Miscelatore monocomando incasso termostatico per doccia, con deviatore a 5 posizioni su piastra singola.



BOX INCASSO

KIT WELLNESS

CROMOTERAPIA

BRACCI E SOFFIONI

PANNELLI DOCCIA

COLONNE DOCCIA

SALISCENDI

DOCCETTE

SHUT-OFF

KIT BORDO VASCA

BOCCHE

FLESSIBILI DOCCIA

# KIT WELLNESS TERMOSTATICI TONDI



## NT 09 S01

Set doccia composto da:  
 Art. 356LU 348N 30: Soffione minimale anticalcare con braccio in ottone Ø 30 cm.  
 Art. 317M 317DM con 333CN 150: Saliscendi minimale con doccetta anticalcare e flessibile conico in ottone cromato.  
 Art. 309 L: presa acqua tipo rotondo pesante.  
 Art. NT 09: Miscelatore incasso termostatico con deviatore e piastra lusso.



## NT 93 7 S02

Set doccia composto da:  
 Art. 359MM30 348N 30: soffione minimale anticalcare in ottone Ø 30 cm, con braccio in ottone cm 30.  
 Art. 317G 321HG con 333CN 150: Saliscendi in ottone cromato e doccetta minimale a 2 funzioni con getti in silicone e flessibile conico in ottone cromato cm 150.  
 Art. N 34 JET: 6 getti minimali anticalcare.  
 Art. NT 93 7: miscelatore monocomando incasso termostatico per doccia con deviatore a tre vie e sette posizioni su unica piastra.



## NT 09 S03

Set doccia composto da:  
 Art. 356LU 348N 30: Soffione minimale anticalcare con braccio in ottone Ø 30 cm.  
 Art. 339N 317DM con 333CN 150: Doccia duplex minimale anticalcare con supporto duplex e flessibile conico in ottone cromato cm 150.  
 Art. 91 MD: Bocca incasso Minimal con deviatore integrato.  
 Art. NT 09: Miscelatore incasso termostatico con deviatore e piastra lusso.

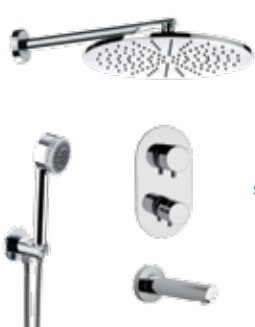

## NT 93 7 S03

Set doccia composto da:  
 Art. 359MM30 348N 30: soffione minimale anticalcare in ottone Ø 30 cm, con braccio in ottone cm 30.  
 Art. 337M 321HG con 333CN 150: Doccia minimale a 2 funzioni, con getti in silicone, supporto doccia duplex in ottone cromato con presa acqua e flessibile conico in ottone cromato cm 150.  
 Art. 91 M: bocca incasso minimale.  
 Art. QT 94: Miscelatore monocomando incasso termostatico per doccia con deviatore a quattro posizioni su piastra unica.

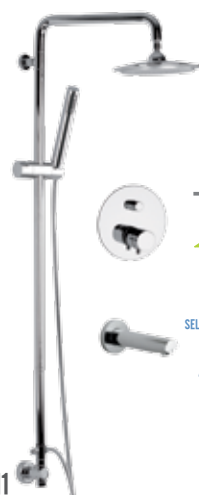

## NT 09 S11

Set doccia composto da:  
 Art. 330U 356LU 317DM 330RA con 333CN 150: Colonna doccia deluxe girevole con deviatore e saliscendi, completa di soffione doccia cromato anticalcare, doccetta minimale, flessibile doccia e supporto presa acqua per colonna.  
 Art. NT 09 L: Miscelatore monocomando incasso termostatico con deviatore e piastra lusso.  
 Art. 91M: Bocca incasso Minimale.



## NT 09 S02

Set doccia composto da:  
 Art. 356LU 348N 30: Soffione minimale anticalcare con braccio in ottone Ø 30 cm.  
 Art. 337M 317DM con 333CN 150: Doccia duplex minimale anticalcare con supporto presa acqua e flessibile conico in ottone cromato cm 150.  
 Art. NT 09: Miscelatore incasso termostatico con deviatore e piastra lusso.



## NT 93 7 S01

Set doccia composto da:  
 Art. 359MM30 348N 30: soffione minimale anticalcare in ottone Ø 30 cm, con braccio in ottone cm 30.  
 Art. 337M 321HG con 333CN 150: Doccia minimale a 2 funzioni, con getti in silicone, supporto doccia duplex in ottone cromato con presa acqua e flessibile conico in ottone cromato cm 150.  
 Art. N 34 JET: 6 getti minimali anticalcare in ottone cromato.  
 Art. NT 93 7: miscelatore monocomando incasso termostatico per doccia con deviatore a tre vie e sette posizioni su unica piastra.



## NT 93 7 S01 UFMCA

Set doccia composto da:  
 Art. 350UFMCA: soffione doccia a parete 50x20cm, in acciaio INOX lucidato a specchio, 2 getti, pioggia e cascata.  
 Art. 317M 317MM con 333CN 150: Saliscendi minimale con doccetta anticalcare e flessibile conico in ottone cromato.  
 Art. 309 L: presa acqua tipo rotondo pesante.  
 Art. NT 93 7: miscelatore monocomando incasso termostatico per doccia con deviatore a tre vie e sette posizioni su unica piastra.



## NT 93 7 S02 UFMCA

Set doccia composto da:  
 Art. 350UFMCA: soffione doccia a parete 50x20cm, in acciaio INOX lucidato a specchio, 2 getti, pioggia e cascata.  
 Art. 337M 317MM con 333CN 150: Doccia duplex minimale anticalcare con supporto presa acqua e flessibile conico in ottone cromato cm 150.  
 Art. NT 93 7: miscelatore monocomando incasso termostatico per doccia con deviatore a tre vie e sette posizioni su unica piastra.



## NT 93 7 S03 UFMCA

Set doccia composto da:  
 Art. 350UFMCA: soffione doccia a parete 50x20cm, in acciaio INOX lucidato a specchio, 2 getti, pioggia e cascata.  
 Art. 339N 317MM con 333CN 150: Doccia duplex minimale anticalcare con supporto duplex e flessibile conico in ottone cromato cm 150.  
 Art. 91 MD: Bocca incasso con deviatore integrato.  
 Art. NT 93 7: miscelatore monocomando incasso termostatico per doccia con deviatore a tre vie e sette posizioni su unica piastra.



## NT 09 S01 UFM

Set doccia composto da:  
 Art. 350UFM: soffione doccia a parete 50x20cm, in acciaio INOX lucidato a specchio, getto pioggia.  
 Art. 337M 317MM con 333CN 150: Doccia duplex minimale anticalcare con supporto presa acqua e flessibile conico in ottone cromato cm 150.  
 Art. 309 L: presa acqua tipo rotondo pesante.  
 Art. NT 09: Miscelatore incasso termostatico con deviatore e piastra lusso.



## NT 09 S02 UFM

Set doccia composto da:  
 Art. 350UFM: soffione doccia a parete 50x20cm, in acciaio INOX lucidato a specchio, getto pioggia.  
 Art. 337M 317MM con 333CN 150: Doccia duplex minimale anticalcare con supporto presa acqua e flessibile conico in ottone cromato cm 150.  
 Art. NT 09: Miscelatore incasso termostatico con deviatore e piastra lusso.



## NT 09 S03 UFM

Set doccia composto da:  
 Art. 350UFM: soffione doccia a parete 50x20cm, in acciaio INOX lucidato a specchio, getto pioggia.  
 Art. 339N 317MM con 333CN 150: Doccia duplex minimale anticalcare con supporto duplex e flessibile conico in ottone cromato cm 150.  
 Art. 91 MD: Bocca incasso con deviatore integrato.  
 Art. NT 09: Miscelatore incasso termostatico con deviatore e piastra lusso.

BOX INCASSO

KIT WELLNESS

CROMOTERAPIA

BRACCI E SOFFIONI

PANNELLI DOCCIA

COLONNE DOCCIA

SALISCENDI

DOCCETTE

SHUT-OFF

KIT BORDO VASCA

BOCCHIE

FLESSIBILI DOCCIA

# CROMOTERAPIA

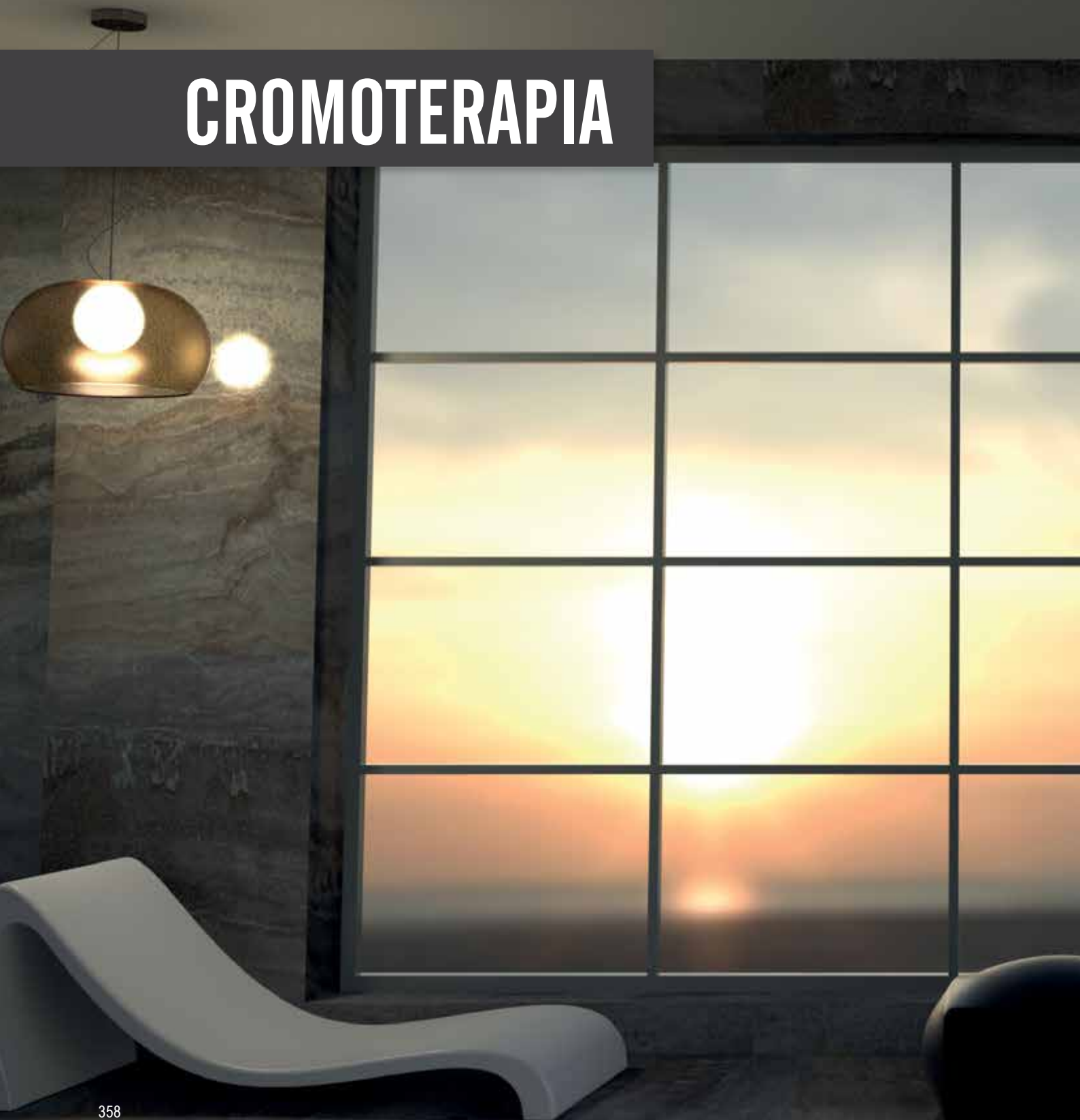





BOX INCASSO

KIT WELLNESS

CROMOTERAPIA

BRACCI E SOFFIONI

PANNELLI DOCCIA

COLONNE DOCCIA

SALISCENDI

DOCCETTE

SHUT-OFF





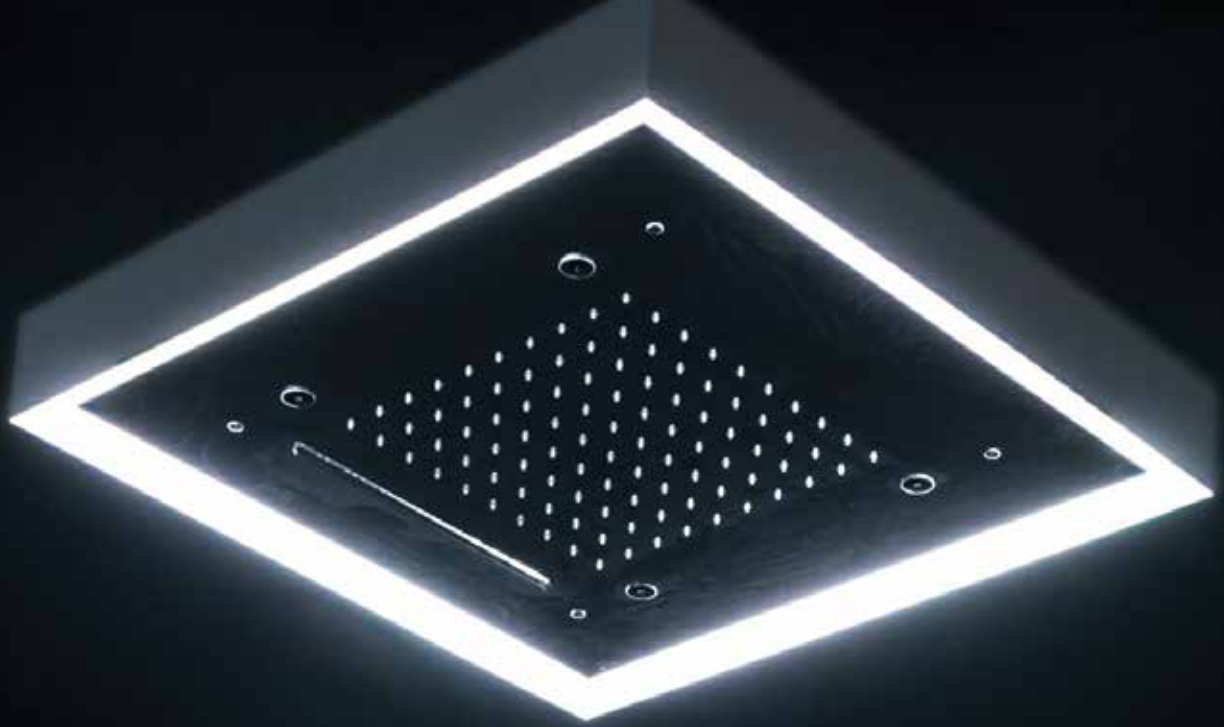

KIT BORDO VASCA

BOCCHE

FLESSIBILI DOCCIA



**SIMBOLOGIE:**

-   
 Con Kit Doccia e flessibile lungo: 120, 150 o 200 cm
-   
 Soffione Anticalcare ed Autopulente
-   
 Getti Anticalcare
-   
 Getto effetto pioggia
-   
 Getto ad ampia copertura effetto pioggia
-   
 Con getto a cascata
-   
 Getto Nebulizzato
-   
 Prodotto Nowità

**IN DOTAZIONE AI MODELLI**



Pulsantiera a parete per accensione luce bianca, selezione colori e cromoterapia automatica.

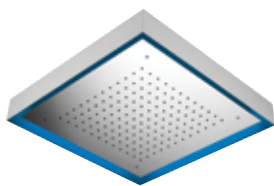

**357 LS57**

Soffione retroilluminato a soffitto in Acciaio INOX anti-calcare 57x57 cm, con getto a pioggia. Luce LED a 7 colori con 40 sfumature, alimentazione dalla rete elettrica con trasformatore a basso voltaggio incluso (12V). Pulsantiera a parete inclusa.

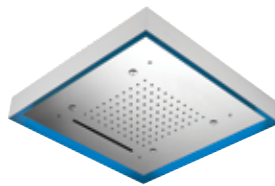

**357 LS57 NC**

Soffione retroilluminato a soffitto in Acciaio INOX anti-calcare 57x57 cm, con 3 funzioni: getto a pioggia, nebulizzazione (4 uscite) ed 1 getto a cascata. Luce LED a 7 colori con 40 sfumature, alimentazione dalla rete elettrica con trasformatore a basso voltaggio incluso (12V). Pulsantiera a parete inclusa.

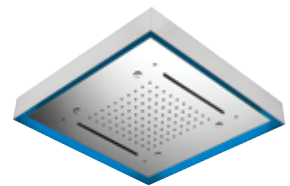

**357 LS57 N2C**

Soffione retroilluminato a soffitto in Acciaio INOX anti-calcare 57x57 cm, con 3 funzioni: getto a pioggia, nebulizzazione (4 uscite) e 2 getti a cascata. Luce LED a 7 colori con 40 sfumature, alimentazione dalla rete elettrica con trasformatore a basso voltaggio incluso (12V). Pulsantiera a parete inclusa.





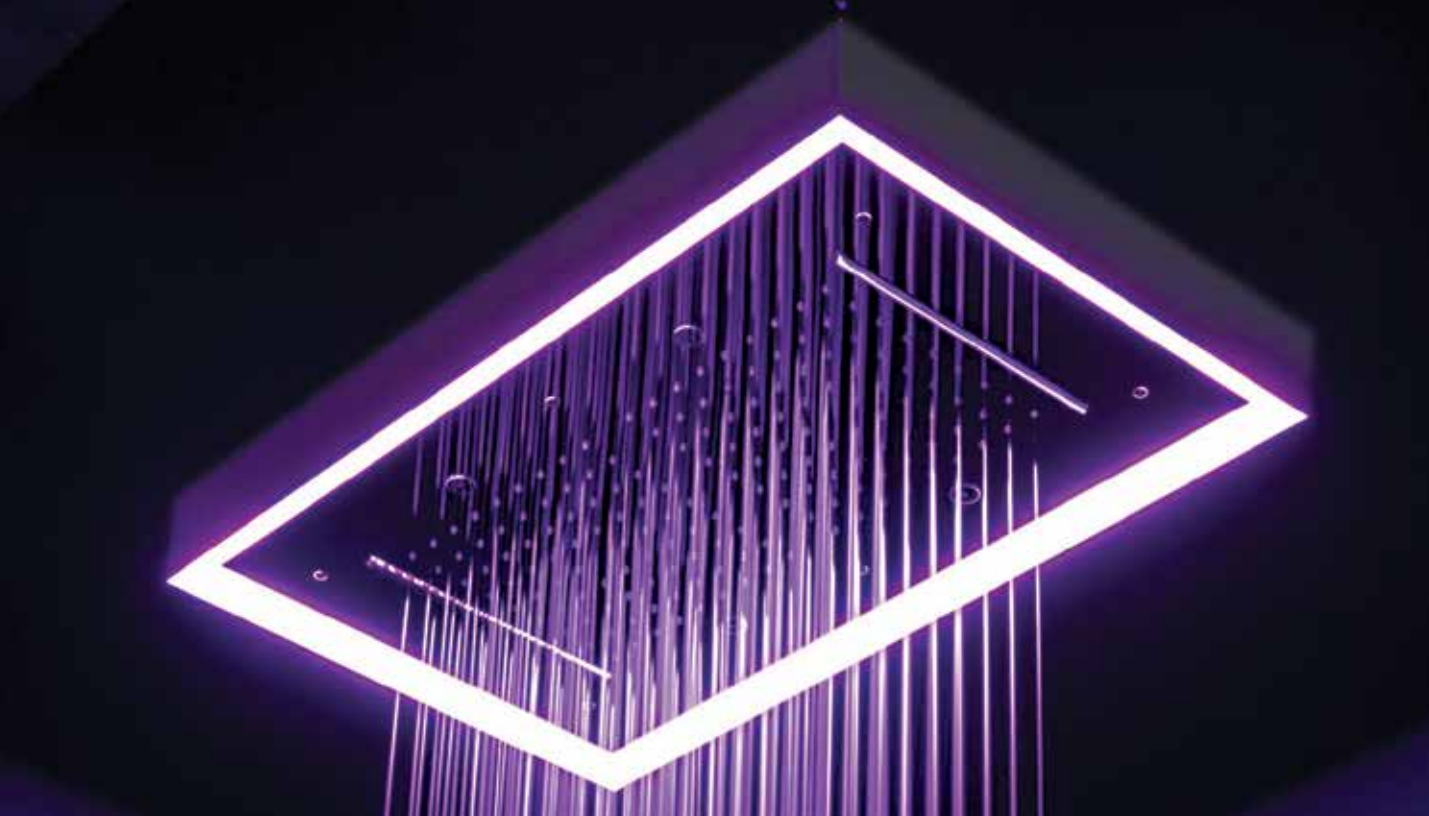

BOX INCASSO

KIT WELLNESS

CROMOTERAPIA

BRACCI E SOFFIONI

PANNELLI DOCCIA

COLONNE DOCCIA

SALISCENDI

DOCCETTE

SHUT-OFF

KIT BORDO VASCA

BOCCHE

FLESSIBILI DOCCIA

IN DOTAZIONE AI MODELLI



Pulsantiera a parete per accensione luce bianca, selezione colori e cromoterapia automatica.



**357 LR7747**

Soffione retroilluminato a soffitto in Acciaio INOX anti-calcare 77x47 cm, con 2 postazioni pioggia. Luce LED a 7 colori con 40 sfumature, alimentazione dalla rete elettrica con trasformatore a basso voltaggio incluso (12V). Pulsantiera a parete inclusa.



**357 LR7747 N2C**

Soffione a soffitto in Acciaio INOX 77x47 cm, con 3 funzioni: 2 getti cascata, nebulizzazione (4 uscite) e 2 postazioni pioggia. Luce LED a 7 colori con 40 sfumature, alimentazione dalla rete elettrica con trasformatore a basso voltaggio incluso (12V). Pulsantiera a parete inclusa.

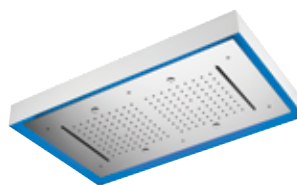



IN DOTAZIONE AI MODELLI



Pulsantiera a parete per accensione luce bianca, selezione colori e cromoterapia automatica.



**357 LM57**

Soffione retroilluminato a soffitto in Acciaio INOX anti-calcare Ø57 cm, getto pioggia. Luce LED a 7 colori con 40 sfumature, alimentazione dalla rete elettrica con trasformatore a basso voltaggio incluso (12V). Pulsantiera a parete inclusa.



**357 LM57 N**

Soffione retroilluminato a soffitto in Acciaio INOX anti-calcare Ø57 cm, con 2 funzioni: getto pioggia e nebulizzazione (4 uscite). Luce LED a 7 colori con 40 sfumature, alimentazione dalla rete elettrica con trasformatore a basso voltaggio incluso (12V). Pulsantiera a parete inclusa.





BOX INCASSO

KIT WELLNESS

**CROMOTERAPIA**

BRACCI E SOFFIONI

PANNELLI DOCCIA

COLONNE DOCCIA

SALISCENDI

DOCCETTE

SHUT-OFF

KIT BORDO VASCA

BOCCHE

FLESSIBILI DOCCIA

IN DOTAZIONE IN BASE AI MODELLI



Pulsantiera a parete per accensione luce bianca, selezione colori e cromoterapia automatica.



W Pulsantiera wireless per accensione luce bianca, selezione colori e cromoterapia automatica.



**357 RS30**

Soffione a soffitto in Acciaio INOX lucidato a specchio 30x30 cm, getto a pioggia. Luce LED a 7 colori con 40 sfumature, alimentazione dalla rete elettrica con trasformatore a basso voltaggio incluso (12V). Pulsantiera a parete inclusa.

**357 RS30W**

Come soffione Art. 357 RS30, con pulsantiera wireless inclusa.

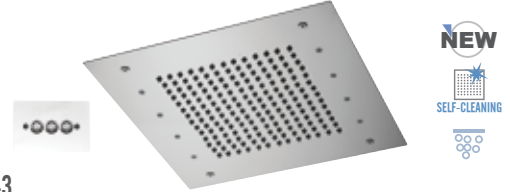

**357 RS43**

Soffione a soffitto in Acciaio INOX lucidato a specchio 43x43 cm, getto a pioggia. Luce LED a 7 colori con 40 sfumature, alimentazione dalla rete elettrica con trasformatore a basso voltaggio incluso (12V). Pulsantiera a parete inclusa.

**357 RS43W**

Come soffione Art. 357 RS43, con pulsantiera wireless inclusa.

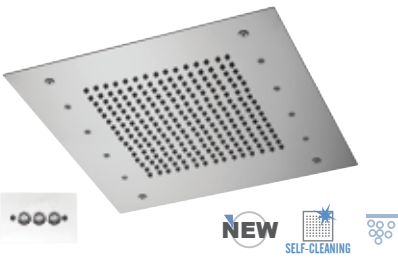

**357 RS50**

Soffione a soffitto in Acciaio INOX lucidato a specchio 50x50 cm, getto a pioggia. Luce LED a 7 colori con 40 sfumature, alimentazione dalla rete elettrica con trasformatore a basso voltaggio incluso (12V). Pulsantiera a parete inclusa.



**357 RS43 NC**

Soffione a soffitto in Acciaio INOX lucidato a specchio 43x43 cm, con 3 funzioni: getto a pioggia, nebulizzazione (4 uscite) e getto a cascata. Luce LED a 7 colori con 40 sfumature, alimentazione dalla rete elettrica con trasformatore a basso voltaggio incluso (12V). Pulsantiera a parete inclusa.

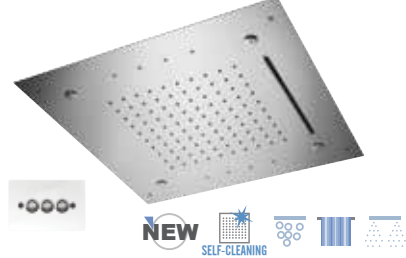

**357 RS50 NC**

Soffione a soffitto in Acciaio INOX lucidato a specchio 50x50 cm, con 3 funzioni: getto a pioggia, nebulizzazione (4 uscite) e getto a cascata. Luce LED a 7 colori con 40 sfumature, alimentazione dalla rete elettrica con trasformatore a basso voltaggio incluso (12V). Pulsantiera a parete inclusa.

**357 RS50W**

Come soffione Art. 357 RS50, con pulsantiera wireless inclusa.

**357 RS43 NCW**

Come soffione Art. 357 RS43 NC, con pulsantiera wireless inclusa.

**357 RS50 NCW**

Come soffione Art. 357 RS50 NC, con pulsantiera wireless inclusa.

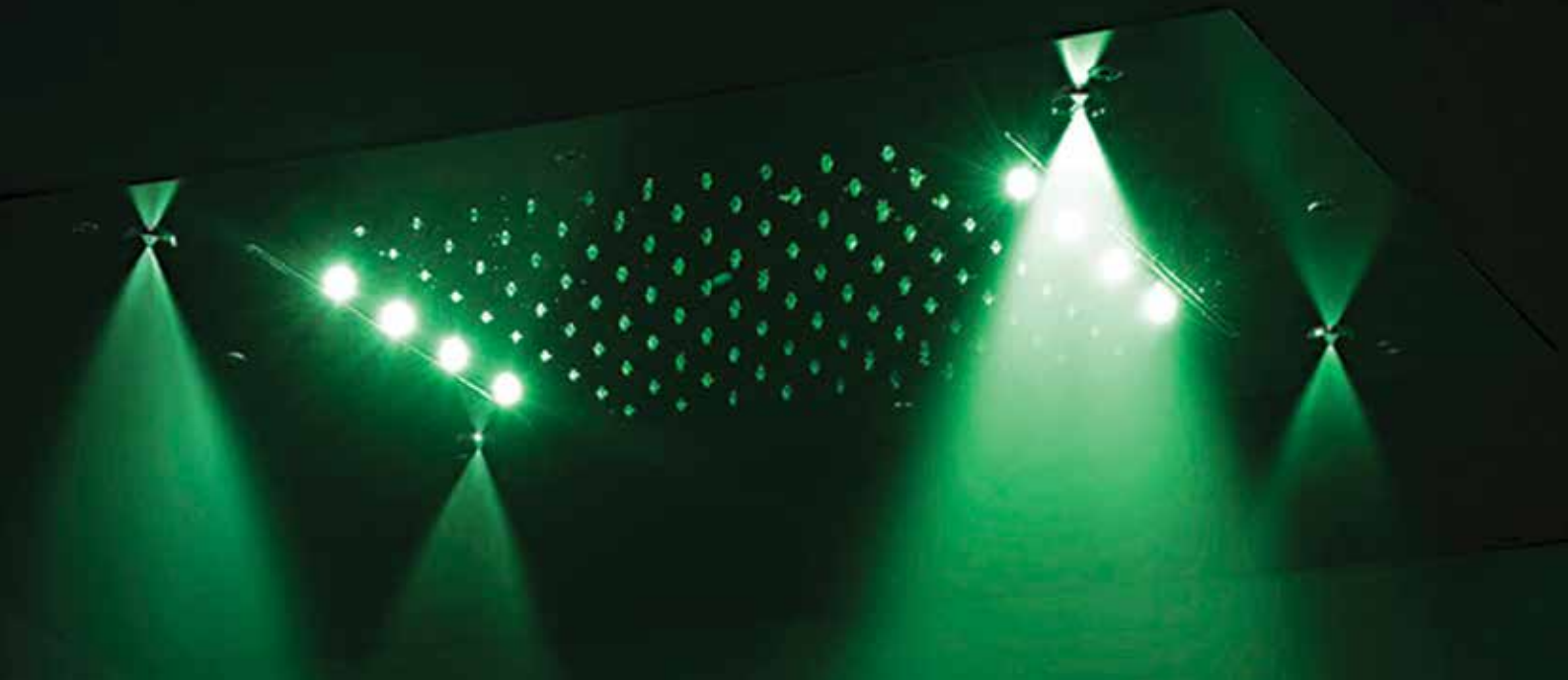

IN DOTAZIONE IN BASE AI MODELLI



Pulsantiera a parete per accensione luce bianca, selezione colori e cromoterapia automatica.



**W**  
Pulsantiera wireless per accensione luce bianca, selezione colori e cromoterapia automatica.



### 357 RR7040

Soffione a soffitto in Acciaio INOX lucidato a specchio 70x40 cm, con 2 postazioni getto a pioggia. Luce LED a 7 colori con 40 sfumature, alimentazione dalla rete elettrica con trasformatore a basso voltaggio incluso (12V). Pulsantiera a parete inclusa.



### 357 RR7040W

Come soffione Art. 357 RR7040, con pulsantiera wireless inclusa.

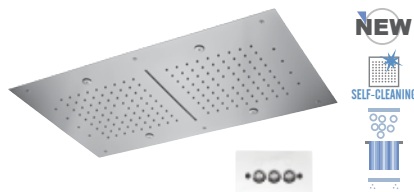

### 357 RR7040 NC

Soffione a soffitto in Acciaio INOX lucidato a specchio 70x40 cm, con 3 funzioni: 2 postazioni getto a pioggia, nebulizzazione (4 uscite) ed 1 getto a cascata centrale. Luce LED a 7 colori con 40 sfumature, alimentazione dalla rete elettrica con trasformatore a basso voltaggio incluso (12V). Pulsantiera a parete inclusa.



### 357 RR7040 NCW

Come soffione Art. 357 RR7040 NC, con pulsantiera wireless inclusa.



### 357 RR7040 N2C

Soffione a soffitto in Acciaio INOX lucidato a specchio 70x40 cm, con 3 funzioni: getto pioggia, nebulizzazione (4 uscite) e 2 getti a cascata laterali. Luce LED a 7 colori con 40 sfumature, alimentazione dalla rete elettrica con trasformatore a basso voltaggio incluso (12V). Pulsantiera a parete inclusa.



### 357 RR7040 N2CW

Come soffione Art. 357 RR7040 N2C, con pulsantiera wireless inclusa.







BOX INCASSO

KIT WELLNESS

**CROMOTERAPIA**

BRACCI E SOFFIONI

PANNELLI DOCCIA

COLONNE DOCCIA

SALISCENDI

DOCCETTE

SHUT-OFF

KIT BORDO VASCA

BOCCHIE

FLESSIBILI DOCCIA

IN DOTAZIONE IN BASE AI MODELLI



Pulsantiera a parete per accensione luce bianca, selezione colori e cromoterapia automatica.



**W**  
Pulsantiera wireless per accensione luce bianca, selezione colori e cromoterapia automatica.

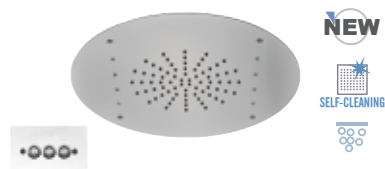

**357 RM42**

Soffione a soffitto in Acciaio INOX lucidato a specchio Ø42 cm, cin getto a pioggia. Luce LED a 7 colori con 40 sfumature, alimentazione dalla rete elettrica con trasformatore a basso voltaggio incluso (12V). Pulsantiera a parete inclusa.



**357 RM55**

Soffione a soffitto in Acciaio INOX lucidato a specchio Ø55 cm, con getto a pioggia. Luce LED a 7 colori con 40 sfumature, alimentazione dalla rete elettrica con trasformatore a basso voltaggio incluso (12V). Pulsantiera a parete inclusa.



**357 RM55N**

Soffione a soffitto in Acciaio INOX lucidato a specchio Ø55 cm, con 2 funzioni: getto a pioggia e nebulizzato (4 uscite). Luce LED a 7 colori con 40 sfumature, alimentazione dalla rete elettrica con trasformatore a basso voltaggio incluso (12V). Pulsantiera a parete inclusa.



**357 RM42W**

Come soffione Art. 357 RM42, con pulsantiera wireless inclusa.



**357 RM55W**

Come soffione Art. 357 RM55, con pulsantiera wireless inclusa.



**357 RM55 NW**

Come soffione Art. 357 RM55 N, con pulsantiera wireless inclusa.



# SOFFIONI







BOX INCASSO

KIT WELLNESS

CROMOTERAPIA

BRACCIE  
SOFFIONI

PANNELLI  
DOCCIA

COLONNE  
DOCCIA

SALISCENDI

DOCCETTE

SHUT-OFF

KIT BORDO  
VASCA

BOCCE

FLESSIBILI  
DOCCIA



**SIMBOLOGIE:**

 Soffione Anticalcare ed Autopulente

 Getto effetto pioggia

 Con getto a cascata.

 Getto Nebulizzato

 Prodotto novità

## SOFFIONI A SOFFITTO CON TELAIO



**NEW**  
  

**357 SFS30**

Soffione a soffitto in Acciaio INOX lucidato a specchio con sistema anticalcare, 30x30 cm con getto a pioggia.

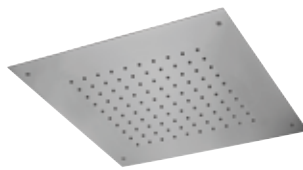

**NEW**  
  

**357 SFS43**

Soffione a soffitto in Acciaio INOX lucidato a specchio con sistema anticalcare, 43x43 cm con getto a pioggia.



**NEW**  
  

**357 SFS 50**

Soffione a soffitto in Acciaio INOX lucidato a specchio con sistema anticalcare, 50x50 cm con getto a pioggia.



**NEW**  
  
  

**357 SFS43 C**

Soffione a soffitto in Acciaio INOX lucidato a specchio con sistema anticalcare, 43x43 cm, a 2 funzioni: getto a pioggia e cascata.



**NEW**  
  
  

**357 SFS 50C**

Soffione a soffitto in Acciaio INOX lucidato a specchio con sistema anticalcare, 50x50 cm, a 2 funzioni: getto a pioggia e cascata.

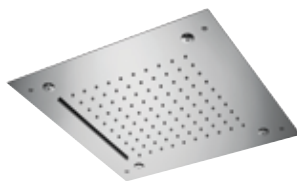

**NEW**  
  
  
  

**357 SFS43 NC**

Soffione a soffitto in Acciaio INOX lucidato a specchio con sistema anticalcare, 43x43 cm, a 3 funzioni: getto a pioggia, nebulizzazione (4 uscite) ed 1 getto a cascata.



**NEW**  
  
  
  

**357 SFS 50NC**

Soffione a soffitto in Acciaio INOX lucidato a specchio con sistema anticalcare, 50x50 cm, a 3 funzioni: getto a pioggia, nebulizzazione (4 uscite) ed 1 getto a cascata.



BOX INCASSO

KIT WELLNESS  
CROMOTERAPIA

BRACCI E SOFFIONI



### 357 SFR 7040

Soffione a soffitto in Acciaio INOX con sistema anti-calcare, 70x40 cm, 2 postazioni pioggia.



### 357 SFR 7040 C

Soffione a soffitto in Acciaio INOX con sistema anti-calcare, 70x40 cm, a 2 funzioni: 2 postazioni pioggia, ed un getto a cascata centrale.



### 357 SFR 7040 NC

Soffione a soffitto in Acciaio INOX lucidato a specchio con sistema anti-calcare, 70x40 cm, a 2 funzioni: 2 postazioni pioggia, nebulizzazione (4 uscite), ed un getto a cascata centrale.

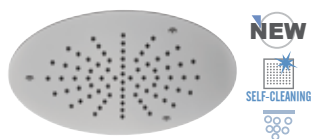

### 357 SFM 30

Soffione a soffitto in Acciaio INOX lucidato a specchio con sistema anti-calcare Ø30 cm, con getto a pioggia.



### 357 SFM 40

Soffione a soffitto in Acciaio INOX lucidato a specchio con sistema anti-calcare Ø40 cm, con getto a pioggia.



### 357 SFM 55

Soffione a soffitto in Acciaio INOX lucidato a specchio con sistema anti-calcare Ø55 cm, con getto a pioggia.



### 357 SFM42 N

Soffione a soffitto in Acciaio INOX lucidato a specchio con sistema anti-calcare Ø42 cm, a 2 funzioni: pioggia e nebulizzazione (4 uscite).



### 357 SFM55 N

Soffione a soffitto in Acciaio INOX lucidato a specchio con sistema anti-calcare Ø55 cm, a 2 funzioni: pioggia e nebulizzazione (6 uscite).

PANNELLI DOCCIA

COLONNE DOCCIA

SALISCENDI

DOCCETTE

SHUT-OFF

KIT BORDO VASCA

BOCCHIE

FLESSIBILI DOCCIA

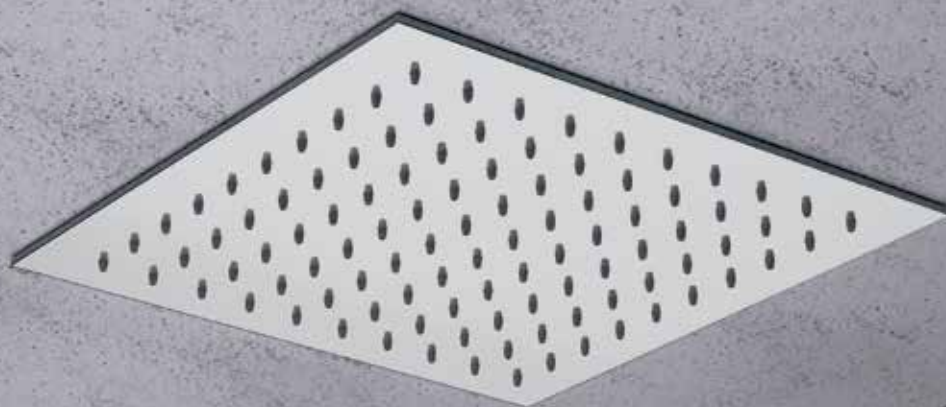

## SOFFIONI A SOFFITTO “EASY FIX”



**357 EFM34**

Soffione doccia EASY FIX in acciaio INOX lucidato a specchio Ø34 cm.



**357 EFM44**

Soffione doccia EASY FIX in acciaio INOX lucidato a specchio Ø44 cm.



**357 EFS34**

Soffione doccia EASY FIX in acciaio INOX lucidato a specchio 34x34 cm.

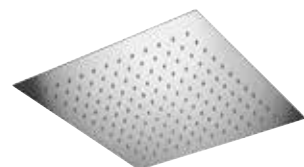

**357 EFS44**

Soffione doccia EASY FIX in acciaio INOX lucidato a specchio 44x44 cm.



## APPLICAZIONE A SOFFITTO “EASY FIX”

1

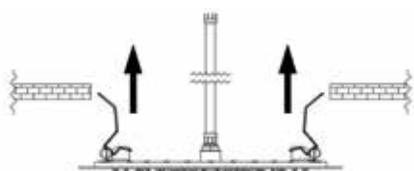

Per questa tipologia di soffione e con questo specifico sistema di fissaggio sono previste quattro molle per ogni soffione.

Nell'immagine 1 si evidenzia il primo movimento necessario: caricare due molle vicine tra loro mettendole quasi in posizione verticale rispetto al soffione ed inserirle all'interno del foro precedentemente preparato. Rilasciare le stesse delicatamente.

2

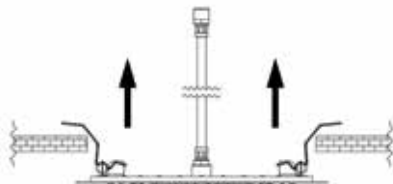

Mantenendo il soffione leggermente inclinato procedere caricando ed inserendo le rimanenti due molle come da immagine 2.

3

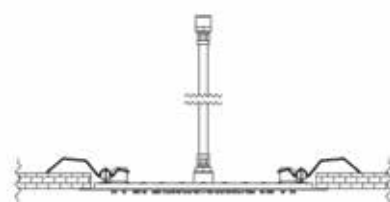

A questo punto rialsciare delicatamente le molle alla loro naturale tensione e, trattengono esternamente il soffione, accompagnare lo stesso verso il totale appoggio al soffitto come da immagine 3.

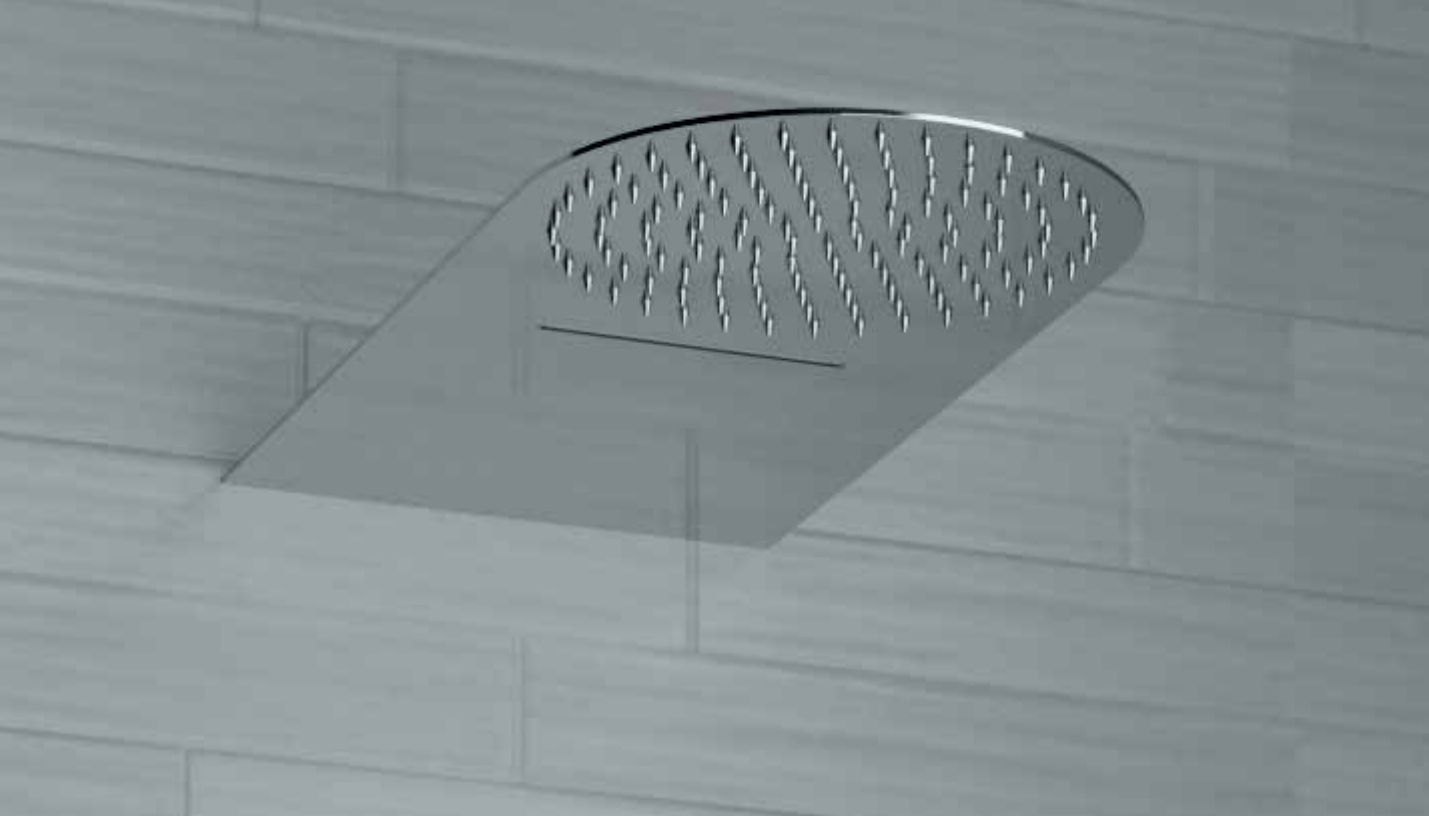

BOX INCASSO

KIT WELLNESS

CROMOTERAPIA

BRACCI E SOFFIONI

## LINEA MINIMALE IN ACCIAIO INOX



PANNELLI DOCCIA

COLONNE DOCCIA

SALISCENDI

DOCCETTE

SHUT-OFF

KIT BORDO VASCA

BOCCHIE

FLESSIBILI DOCCIA



### 357 UF M20X

Soffione doccia ultra piatto Ø20 cm in acciaio INOX lucidato a specchio.



### 357 UF M25X

Soffione doccia ultra piatto Ø25 cm in acciaio INOX lucidato a specchio.



### 357 UF M30X

Soffione doccia ultra piatto Ø30 cm in acciaio INOX lucidato a specchio.



### 357UF M40X

Soffione doccia ultra piatto Ø40 cm in acciaio INOX lucidato a specchio.



### 350 UFMX

Soffione doccia ultrapiatto 50x25 cm, a parete in acciaio INOX lucidato a specchio.



### 350 UFM CAX

Soffione doccia ultrapiatto 50x25 cm, a parete in acciaio INOX lucidato a specchio, 2 funzioni: a pioggia e cascata.







## LINEA QUADRATA IN ACCIAIO INOX



### 357 UF S20X

Soffione doccia ultra piatto 20x20 cm in acciaio INOX lucidato a specchio.



### 357 UF S25X

Soffione doccia ultra piatto 25x25 cm in acciaio INOX lucidato a specchio.

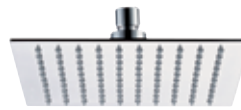

### 357 UF S30X

Soffione doccia ultra piatto 30x30 cm in acciaio INOX lucidato a specchio.

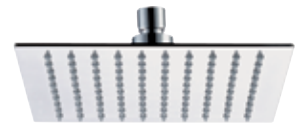

### 357 UF S40X

Soffione doccia ultra piatto 40x40 cm in acciaio INOX lucidato a specchio.



### 350 UFX

Soffione doccia ultrapiatto 50x25 cm, a parete in acciaio INOX lucidato a specchio.



### 350 UF CAX

Soffione doccia ultrapiatto 50x25 cm, a parete in acciaio INOX lucidato a specchio, a 2 funzioni: getto a pioggia e cascata.



### 357 UFRX

Soffione doccia ultra piatto 33x22 cm in acciaio INOX lucidato a specchio.



### 350 SSX

Soffione doccia a parete 50x20 cm, in acciaio INOX lucidato a specchio.



### 350 SS CAX

Soffione doccia a parete 50x20 cm, in acciaio INOX lucidato a specchio, a 2 funzioni: getto a pioggia e cascata.







## LINEA QUADRATA CON ANGOLI ARROTONDATI IN ACCIAIO INOX

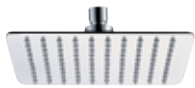

### 357 UFD 20X

Soffione doccia quadrato con angoli arrotondati ultrapiatto in Acciaio Inox 20x20 cm lucidato a specchio, con getti in silicone anticalcare.

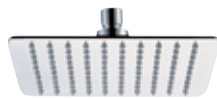

### 357 UFD 25X

Soffione doccia quadrato con angoli arrotondati ultrapiatto in Acciaio Inox 25x25 cm lucidato a specchio, con getti in silicone anticalcare.

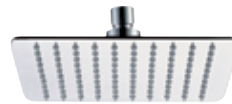

### 357 UFD 30X

Soffione doccia quadrato con angoli arrotondati ultrapiatto in Acciaio Inox 30x30 cm lucidato a specchio, con getti in silicone anticalcare.

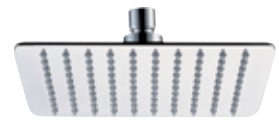

### 357 UFD 40X

Soffione doccia quadrato con angoli arrotondati ultrapiatto in Acciaio Inox 40x40 cm lucidato a specchio, con getti in silicone anticalcare.

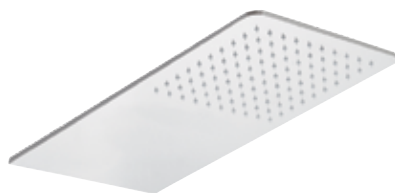

### 350 UFDX

Soffione doccia ultrapiatto 5mm, 50x25 cm, a parete in acciaio INOX lucidato a specchio.

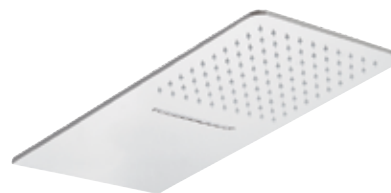

### 350 UFD CAX

Soffione doccia ultrapiatto 5mm, 50x25 cm, a parete in acciaio INOX lucidato a specchio, a 2 funzioni: getto a pioggia e cascata.

BOX INCASSO

KIT WELLNESS

CROMOTERAPIA

BRACCI E SOFFIONI

PANNELLI DOCCIA

COLONNE DOCCIA

SALISCENDI

DOCCETTE

SHUT-OFF

KIT BORDO VASCA

BOCCHE

FLESSIBILI DOCCIA



## SOFFIONI A PARETE MINIMALI

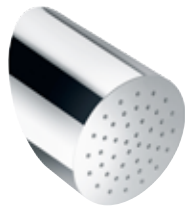

### 350 XN

Soffione doccia Ø 15,4 cm, lunghezza 29,17 cm, a parete in acciaio INOX lucidato a specchio.

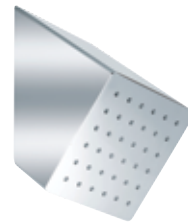

### 350 XS

Soffione doccia 15,5x15,5 cm, lunghezza 25,05 cm, a parete in acciaio INOX lucidato a specchio.





BOX INCASSO

KIT WELLNESS  
CROMOTERAPIA

BRACCI E SOFFIONI

PANNELLI DOCCIA

COLONNE DOCCIA

SALISCENDI

DOCCETTE

SHUT-OFF

KIT BORDO VASCA

BOCCHIE

FLESSIBILI DOCCIA

## TUTTO IN OTTONE



**359 SSX**

Soffione SQ, completamente in ottone cromato, con 144 getti in silicone soffice autopulente anticalcare, cm 20x20.



**359 WX**

Soffione a pioggia rettangolare, a snodo, 24x14, cromo, con 128 getti in silicone anticalcare, completamente in ottone.



**359 SS LX**

Soffione a pioggia quadrato piatto, a snodo, 30x30, cromo, con 144 getti in silicone anticalcare, completamente in ottone.



**359 SS XLX**

Soffione a pioggia quadrato piatto, a snodo, 35x35, cromo, con 225 getti in silicone anticalcare, completamente in ottone.



**359 MM 20X**

Soffione doccia minimale piatto in ottone cromato con getti in silicone morbido, autopulente, Ø 20 cm.



**359 MM 30X**

Soffione doccia minimale piatto in ottone cromato con getti in silicone morbido, autopulente, Ø 30 cm.



**359 MM XLX**

Soffione a pioggia piatto, completamente in ottone, a snodo, Ø 35 cm, cromato con 216 getti in silicone anticalcare.



**359 R15X**

Soffione a pioggia 60 getti "Rain" completamente in ottone cromato con terminale getti in silicone, autopulente, anticalcare, a snodo, Ø 15.



**359 BEX**

Soffione a pioggia 30 getti "Bell" completamente in ottone cromato, a snodo.



**359 B20X**

Soffione a "Pioggia" Ø20 cm, completamente in ottone cromato, con funzione raccoglimento acqua usati anche in situazioni di bassa pressione.



**359 S18X**

Soffione a pioggia "Sun" completamente in ottone cromato, a snodo, Ø 18 cm (66 getti).



**359 S25X**

Soffione a pioggia "Sun" completamente in ottone cromato, a snodo, Ø 25 cm (114 getti).





## BOCCHIE A PARETE

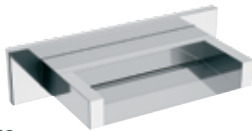

**359 ZC**

Soffione doccia con getto a cascata.

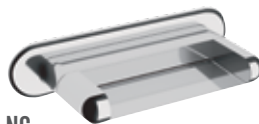

**359 NC**

Soffione doccia con getto a cascata bordi arrotondati.



**359 XL**

Soffione/bocca a cascata ad L in acciaio INOX lucidato a specchio.

**NEW**



**359 XS**

Soffione/bocca a cascata ad incasso squadrata in acciaio INOX lucidato a specchio.

**NEW**



**359 XM**

Soffione/bocca a cascata ad incasso con angoli arrotondati in acciaio INOX lucidato a specchio.

**NEW**



## BODY JETS



**Q 34 JET**

Getto in ottone cromato per sistema doccia, con ugelli in silicone, anticalcare.



**N 34 JET**

Getto in ottone cromato per sistema doccia, con ugelli in silicone, anticalcare.

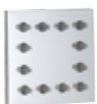

**QX 34 JET**

Getto quadrato 5x5 cm, in acciaio INOX lucidato a specchio per sistema doccia, anticalcare, con snodo.



**NEW**



**NX 34 JET**

Getto rotondo Ø5 cm, in acciaio INOX lucidato a specchio per sistema doccia, anticalcare, con snodo.



**NEW**

## SOFFIONI IN ABS



### 354 QIX

Soffione doccia quadrato con angoli arrotondati, ultrapiatto, cm 20x20, in abs cromato, con getti in silicone autopulenti e anticalcare.



### 356 REX

Soffione doccia rettangolare in abs bicolore bianco lucido e cromato, dimensione cm 35x25 con getti in silicone autopulenti e anticalcare.

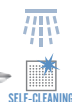

### 356 AD 20X

Soffione a pioggia squadrato con angoli arrotondati, in ABS cromato, 20x20 cm, con getti in silicone anticalcare.



### 356 MD 20X

Soffione doccia minimale Ø 20 cm, in abs lusso, cromato, con getti in silicone autopulenti e anticalcare.



### 356 MD 25X

Soffione doccia minimale Ø 25 cm, in abs lusso, cromato, con getti in silicone autopulenti e anticalcare.



### 356 MD 30X

Soffione doccia minimale Ø 30 cm, in abs lusso, cromato, con getti in silicone autopulenti e anticalcare.



### 356 SD 20X

Soffione doccia quadrato 20x20 cm, in abs lusso, cromato, con getti in silicone autopulenti e anticalcare.



### 356 SD 25X

Soffione doccia quadrato 25x25 cm, in abs lusso, cromato, con getti in silicone autopulenti e anticalcare.



### 356 SD 30X

Soffione doccia quadrato 30x30 cm, in abs lusso, cromato, con getti in silicone autopulenti e anticalcare.



### 354 EC 20X

Soffione a pioggia minimale, in ABS cromato, Ø 20 cm, con getti in silicone anticalcare.



### 356 V3X

Soffione a 3 funzioni con tasto centrale per il cambio dei getti: getto pioggia, nebulizzazione e misto, in ABS cromato, Ø 23 cm, con getti in silicone anticalcare.



BOX INCASSO

KIT WELLNESS

CROMOTERAPIA

BRACCI E SOFFIONI

PANNELLI DOCCIA

COLONNE DOCCIA

SALISCENDI

DOCCETTE

SHUT-OFF

KIT BORDO VASCA

BOCCHIE

FLESSIBILI DOCCIA

## SOFFIONI IN ABS



### 356 DKX

Soffione a pioggia "Disk", ultrapiatto, con 104 getti in silicone anticalcare, a snodo, Ø 24 cm.



### 356 LUX

Soffione a pioggia "Luna", ultrapiatto, cromo-satinato, con 104 getti in silicone anticalcare, a snodo, Ø 24 cm.



### 356 S

Soffione a pioggia "Square", in ABS cromo-satinato, con 104 getti in silicone anticalcare, a snodo, cm 23 x 23.



### 353 15

Soffione a pioggia Ø 15 cm, con getti anticalcare e snodo.



### 353 23

Soffione a pioggia Ø 23 cm, con getti anticalcare e snodo.



### 354 PLX

Soffione a pioggia Ø 16 cm, con getti anticalcare e snodo.



### 354 DVX

Soffione a pioggia Ø 24 cm, con getti anticalcare e snodo.



### 350 HGX

Braccio doccia con soffione integrato a disco, anticalcare a 2 funzioni.



### 350 GRX

Braccio doccia con soffione integrato a disco, anticalcare a 3 funzioni.



### 350 XLX

Braccio doccia con soffione integrato a disco, anticalcare a 4 funzioni.



### 350 MRX

Braccio doccia con soffione integrato a disco, anticalcare.



### 351 A

Soffione con disco anticalcare, a snodo.



### 352

Soffione con disco ostaform, a snodo.



### 358 GR

Soffione cromo e satinato con disco anticalcare a snodo con 4 funzioni, autopulente.



### 358 MO

Soffione cromo con disco anticalcare a snodo con 3 funzioni, autopulente.



### 355 FO

Soffione con disco anticalcare, autopulente, a snodo con 2 funzioni.



## BRACCI DOCCIA



340

Braccio doccia con rosetta, e soffione snodato, il tutto in ottone cromato. cm 20, 30.



342

Braccio doccia in ottone cromato, con rosetta, 1/2Mx1/2M.



342 S

Braccio doccia in ottone cromato, con rosetta, 1/2Mx1/2M, lunghezza cm 30.



344

Braccio doccia pesante in ottone cromato, cm 20.



345

Braccio doccia lusso cm 20, in ottone cromato.



346

Braccio doccia, conico, in ottone cromato, cm 20.



343

Braccio doccia in ottone cromato con rosetta, 1/2Mx1/2M. cm 20, 30, 40.



NEW

343 L

Braccio doccia in ottone cromato con rosetta, 1/2Mx1/2M. cm 30, 40.



348 N

Braccio doccia "Minimal" in ottone cromato, con rosetta, 1/2Mx1/2M. cm 20, 30, 40, 50.



N 348 ND

Braccio doccia Minimal in ottone cromato con rosetta e con deviatore integrato e doppia uscita 1/2 per attacco sia del soffione che del flessibile doccia. 1/2MX1/2MX1/2M. cm 20, 30, 40, 50.



348 S

Braccio doccia quadrato, completo di rosetta quadrata, completamente in ottone cromato, 1/2Mx1/2M. cm 30, 40.



348 Q

Braccio doccia Q in ottone cromato, con rosetta, 1/2Mx1/2M. cm 30, 40.



347 N

Braccio doccia da soffitto, serie Minimal, completamente in ottone cromato, 1/2Mx1/2M. cm 10, 20, 30, 40, 50.



347 S

Braccio doccia da soffitto quadrato, completamente in ottone cromato, 1/2Mx1/2M. cm 10, 20, 30, 40, 50.

BOX INCASSO

KIT WELLNESS

CROMOTERAPIA

BRACCI E SOFFIONI

PANNELLI DOCCIA

COLONNE DOCCIA

SALISCENDI

DOCCETTE

SHUT-OFF

KIT BORDO VASCA

BOCCHIE

FLESSIBILI DOCCIA

# PANNELLI DOCCIA



BOX INCASSO

KIT WELLNESS

CROMOTERAPIA

BRACCI E SOFFIONI

**PANNELLI DOCCIA**

COLONNE DOCCIA

SALISCENDI

DOCCETTE

SHUT-OFF

KIT BORDO VASCA

BOCCHE

FLESSIBILI DOCCIA



**SIMBOLOGIE:**



Termostatico.



Con Kit Doccia e flessibile lungo 150 o 200 cm.



Doccetta Anti-calcare



Anti-calcare ed Autopulente.



Body Jets Anti-calcare



Getto effetto pioggia



Getto ad ampia copertura effetto pioggia



Con getto a cascata.



Prodotto novità



# PANNELLI DOCCIA



## 330 QM20

Pannello doccia a parete, monocomando con deviatore a 2 vie, in acciaio INOX lucidato a specchio, getto a pioggia anti-calcare, doccetta anti-calcare in ABS cromato, flessibile in PVC da 150 cm.



## 330 QM20 J

Pannello doccia a parete, monocomando con deviatore a 3 vie, in acciaio INOX lucidato a specchio, getto a pioggia anti-calcare, body jets anti-calcare, doccetta anti-calcare in ABS cromato, flessibile in PVC da 150 cm.

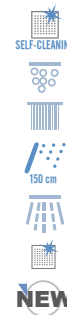

## 330 QM20 JC

Pannello doccia a parete, monocomando con deviatore a 4 vie, in acciaio INOX lucidato a specchio, getto a pioggia anti-calcare e getto a cascata, body jets anti-calcare, doccetta anti-calcare in ABS cromato, flessibile in PVC da 150 cm.

# PANNELLI DOCCIA TERMOSTATICI



## 330 QMT20

Pannello doccia a parete termostatico coassiale, monocomando con deviatore a 2 vie, in acciaio INOX lucidato a specchio, getto a pioggia anti-calcare, doccetta anti-calcare in ABS cromato, flessibile in PVC da 150 cm.



## 330 QMT20 J

Pannello doccia a parete termostatico, monocomando con deviatore a 3 vie, in acciaio INOX lucidato a specchio, getto a pioggia anti-calcare, body jets anti-calcare, doccetta anti-calcare in ABS cromato, flessibile in PVC da 150 cm.



## 330 QMT20 JC

Pannello doccia a parete termostatico, monocomando con deviatore a 4 vie, in acciaio INOX lucidato a specchio, getto a pioggia anti-calcare, body jets anti-calcare, doccetta anti-calcare in ABS cromato, flessibile in PVC da 150 cm.

# PANNELLI DOCCIA AD INCASSO



## 330 QI15 J

Pannello doccia ad incasso, monocomando con deviatore a 3 vie, in acciaio INOX lucidato a specchio, getto a pioggia anti-calcare, body jets anti-calcare, doccetta anti-calcare in ABS cromato, flessibile in PVC da 150 cm.



## 330 QI15 J

Pannello doccia ad incasso termostatico, monocomando con deviatore a 3 vie, in acciaio INOX lucidato a specchio, getto a pioggia anti-calcare, body jets anti-calcare, doccetta anti-calcare in ABS cromato, flessibile in PVC da 150 cm.



## 330 QI15 JC

Pannello doccia ad incasso termostatico, monocomando con deviatore a 4 vie, in acciaio INOX lucidato a specchio, getto a pioggia anti-calcare, getto a cascata, body jets anti-calcare, doccetta anti-calcare in ABS cromato, flessibile in PVC da 150 cm.

BOX INCASSO

KIT WELLNESS

CROMOTERAPIA

BRACCI E SOFFIONI

PANNELLI DOCCIA

COLONNE DOCCIA

SALISCENDI

DOCCETTE

SHUT-OFF

KIT BORDO VASCA

BOCCHE

FLESSIBILI DOCCIA



# COLONNE DOCCIA





BOX INCASSO

KIT WELLNESS

CROMOTERAPIA

BRACCI E SOFFIONI

PANNELLI DOCCIA

COLONNE DOCCIA

SALISCENDI

DOCCE

SHUT-OFF

KIT BORDO VASCA

BOCCHE

FLESSIBILI DOCCIA



**SIMBOLOGIE:**

-   
 Termostatico.
-   
 Termostatico corpo freddo.
-   
 Con Kit Doccia e flessibile lungo 150 o 200 cm.
-   
 Doccetta Anti-calcare.
-   
 Anti-calcare ed Autopulente.
-   
 Colonna doccia girevole.
-   
 Colonna doccia girevole e telescopica.
-   
 Prodotto novità
- 

**GETTI DOCCETTE:**

-   
 Getto intenso esterno con getto effetto pioggia internamente
-   
 Getto con massaggio intenso a risparmio idrico
-   
 Posizione d'interruzione getto
-   
 Massaggio vigoroso ampia copertura effetto pioggia
-   
 Getto Esterno
-   
 Ampio getto pioggia a risparmio idrico
-   
 Getto spray delicato ad ampia copertura con getto vigoroso all'esterno a risparmio idrico
-   
 Getto vigoroso ad ampia copertura effetto pioggia
-   
 Getto effetto pioggia
-   
 Massaggio con getto vigoroso concentrato
-   
 Getto aerato intenso
-   
 Getto vigoroso concentrato e getto esterno
-   
 Getto ad ampia copertura effetto pioggia
-   
 Massaggio con getto vigoroso ed ampio
-   
 Pioggia soft a risparmio idrico
-   
 Getto soft aerato mischiato ad un getto vigoroso a risparmio idrico
-   
 Con getto a cascata.

# COLONNE DOCCIA TELESCOPICHE A 3 VIE

Per chi non vuole rinunciare ad un rilassante bagno caldo e desidera allo stesso tempo avere una soluzione doccia completa e di appagante impatto estetico. Miscelatore esterno vasca-doccia a tre uscite (bocca, doccetta e soffione), con doppio deviatore integrato nel corpo miscelatore. La colonna telescopica con estensione da 120 a 150 cm è un plus che la rende ancor più funzionale.



**W 34 AUFM20**

Miscelatore vasca/doccia serie Winner con attacco superiore da 3/4" ed attacco inferiore da 1/2", colonna doccia telescopica, doccetta in ABS cromato anti-calcare a 4 funzioni, con flessibile 333 CNX 150 cm e soffione ultrapiatto Ø 20 cm, in acciaio inox lucidato a specchio con getti in silicone anti-calcare.

- 
- 
- 
- 
- 
- 
- 
- 



**W 34 AEC20**

Miscelatore vasca/doccia serie Winner con attacco superiore da 3/4" ed attacco inferiore da 1/2", colonna doccia telescopica, doccetta in ABS cromato anti-calcare a 4 funzioni, con flessibile 333 CNX 150 cm e soffione a pioggia, in ABS cromato, Ø 20 cm, con getti in silicone anti-calcare.

- 
- 
- 
- 
- 
- 
- 
- 



### L 34 AUFM20

Miscelatore vasca/doccia serie Class Line con attacco superiore da 3/4" ed attacco inferiore da 1/2", con colonna doccia telescopica, doccetta in ABS cromato anti-calcare a 4 funzioni, con flessibile 333 CNX 150 cm e soffione ultrapiatto Ø 20 cm, in acciaio inox lucidato a specchio con getti in silicone anti-calcare.



### L 34 AMD20

Miscelatore vasca/doccia serie Class Line con attacco superiore da 3/4" ed attacco inferiore da 1/2", con colonna doccia telescopica, doccetta in ABS cromato anti-calcare a 4 funzioni, con flessibile 333 CNX 150 cm e soffione a pioggia in ABS cromato, Ø 20 cm, con getti in silicone autopulenti.



### D 34 AUFD20

Miscelatore vasca/doccia serie Dream con attacco superiore da 3/4" ed attacco inferiore da 1/2", con colonna doccia telescopica, doccetta in ABS cromato anti-calcare a 4 funzioni, con flessibile 333 CNX 150 cm e soffione doccia quadrato con angoli arrotondati ultrapiatto in acciaio INOX 20x20 cm lucidato a specchio con getti in silicone anti-calcare.



### D 34 AAD20

Miscelatore vasca/doccia serie Dream con attacco superiore da 3/4" ed attacco inferiore da 1/2", con colonna doccia telescopica, doccetta in ABS cromato anti-calcare a 4 funzioni, con flessibile 333 CNX 150 cm e soffione a pioggia quadrato con angoli arrotondati, in ABS cromato, 20x20 cm, con getti in silicone anti-calcare.



### I 34 AUFD20

Miscelatore vasca/doccia serie Infinity con attacco superiore da 3/4" ed attacco inferiore da 1/2", con colonna doccia telescopica, doccetta in ABS cromato anti-calcare a 4 funzioni, con flessibile 333 CNX 150 cm e soffione doccia quadrato con angoli arrotondati ultrapiatto in acciaio INOX 20x20 cm lucidato a specchio con getti in silicone anti-calcare.



### I 34 AAD20

Miscelatore vasca/doccia serie Infinity con attacco superiore da 3/4" ed attacco inferiore da 1/2", con colonna doccia telescopica, doccetta in ABS cromato anti-calcare a 4 funzioni, con flessibile 333 CNX 150 cm e soffione a pioggia quadrato con angoli arrotondati, in ABS cromato, 20x20 cm, con getti in silicone anti-calcare.



BOX INCASSO

KIT WELLNESS

CROMOTERAPIA

BRACCI E SOFFIONI

PANNELLI DOCCIA

COLONNE DOCCIA

SALISCENDI

DOCCETTE

SHUT-OFF

KIT BORDO VASCA

BOCCHIE

FLESSIBILI DOCCIA



## COLONNE DOCCIA TELESCOPICHE TERMOSTATICHE

La rubinetteria termostatica, con i suoi indiscutibili pregi, sta prendendo giustamente sempre più mercato. Viene qui proposta corredata dalla colonna telescopica con estensione da 120 a 150 cm che la rende ancor più funzionale.



### EQ 32 AUFM20

Miscelatore doccia termostatico con attacco superiore da 3/4" ed attacco inferiore da 1/2" con deviatore integrato, colonna doccia telescopica, doccetta in ABS cromato anti-calcare a 4 funzioni, con flessibile 333 CNX 150 cm e soffione ultrapiatto Ø 20 cm, in acciaio INOX lucidato a specchio.



### EQ 32 AEC20

Miscelatore doccia termostatico con attacco superiore da 3/4" ed attacco inferiore da 1/2" con deviatore integrato, colonna doccia telescopica, doccetta in ABS cromato anti-calcare a 4 funzioni, con flessibile 333 CNX 150 cm e soffione a pioggia, in ABS cromato, Ø 20 cm, con getti in silicone anti-calcare.







### EQ 32 AUFM25

Miscelatore doccia termostatico con attacco superiore da 3/4" ed attacco inferiore da 1/2" con deviatore integrato, colonna doccia telescopica, doccetta in ABS cromato anti-calcare a 4 funzioni, con flessibile 333 CNX 150 cm e soffione ultrapiatto Ø 25 cm, in acciaio INOX lucidato a specchio.



### EQ 32 AMD20

Miscelatore doccia termostatico con attacco superiore da 3/4" ed attacco inferiore da 1/2" con deviatore integrato, colonna doccia telescopica, doccetta in ABS cromato anti-calcare a 4 funzioni, con flessibile 333 CNX 150 cm e soffione lusso a pioggia, in ABS cromato, Ø 20 cm, con getti in silicone anti-calcare.



### EQ 32 A8CPUFD20

Miscelatore doccia termostatico con attacco superiore da 3/4" ed attacco inferiore da 1/2" con deviatore integrato, colonna doccia telescopica, doccetta in ABS cromato anti-calcare a 3 funzioni, con pulsante per il cambio dei getti e flessibile 333 CNX 150 cm e soffione ultrapiatto quadrato con angoli arrotondati 20x20 cm, in acciaio INOX lucidato a specchio.



### EQ 32 A8CPAD20

Miscelatore doccia termostatico con attacco superiore da 3/4" ed attacco inferiore da 1/2" con deviatore integrato, colonna doccia telescopica, doccetta in ABS cromato anti-calcare a 3 funzioni, con pulsante per il cambio dei getti e flessibile 333 CNX 150 cm e soffione a pioggia quadrato con angoli arrotondati, in ABS cromato, 20x20 cm, con getti in silicone anti-calcare.

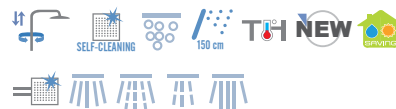

### EQ 32 A8CPUFD25

Miscelatore doccia termostatico con attacco superiore da 3/4" ed attacco inferiore da 1/2" con deviatore integrato, colonna doccia telescopica, doccetta in ABS cromato anti-calcare a 3 funzioni, con pulsante per il cambio dei getti e flessibile 333 CNX 150 cm e soffione ultrapiatto quadrato con angoli arrotondati 25x25 cm, in acciaio INOX lucidato a specchio.



### EQ 32 A8MPMD20

Miscelatore doccia termostatico con attacco superiore da 3/4" ed attacco inferiore da 1/2" con deviatore integrato, colonna doccia telescopica, doccetta in ABS cromato anti-calcare a 4 funzioni, con pulsante per il cambio dei getti e flessibile 333 CNX 150 cm e soffione lusso a pioggia, in ABS cromato, Ø 20 cm, con getti in silicone anti-calcare.



BOX INCASSO

KIT WELLNESS

CROMOTERAPIA

BRACCI E SOFFIONI

PANNELLI DOCCIA

COLONNE DOCCIA

SALISCENDI

DOCCETTE

SHUT-OFF

KIT BORDO VASCA

BOCCHE

FLESSIBILI DOCCIA





## COLONNE DOCCIA TELESCOPICHE CON PRESA ACQUA ESTERNA



### 330A 9MO UFM20 NRA

Set doccia composto da: deviatore con presa ad acqua 330NRA e flessibile a muro 50 cm, colonna doccia telescopica 329A con centralina, doccetta anti-calcare a 4 funzioni 319MO, con flessibile in acciaio INOX da 150 cm, e soffione 357UFM20 ultrapiatto Ø 20 cm, in acciaio INOX lucidato a specchio.



### 330A 9MO EC20 NRA

Set doccia composto da: deviatore con presa ad acqua 330NRA e flessibile a muro 50 cm, colonna doccia telescopica 329A con centralina, doccetta in ABS cromato anti-calcare a 4 funzioni 319MO, con flessibile da 150 cm, e soffione 354EC20 ultrapiatto Ø 20 cm, in ABS cromato.



### 330A 8CP UFD20 NRA

Set doccia composto da: deviatore con presa ad acqua 330NRA e flessibile a muro 50 cm, colonna doccia telescopica 329A con centralina, doccetta in ABS cromato anti-calcare a 4 funzioni 318CP, con flessibile in acciaio INOX da 150 cm, e soffione 357UFD20 ultrapiatto 20x20 cm, in acciaio INOX lucidato a specchio.

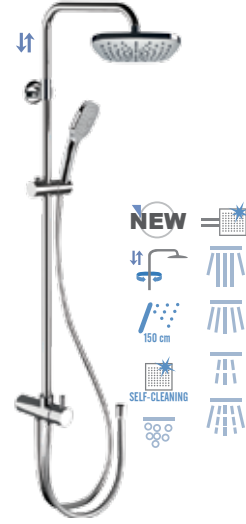

### 330A 8CP AD20 NRA

Set doccia composto da: deviatore con presa ad acqua 330NRA e flessibile a muro 50 cm, colonna doccia telescopica 329A con centralina, doccetta in ABS cromato anti-calcare a 4 funzioni 318CP, con flessibile da 150 cm, e soffione 356AD20 ultrapiatto 20x20 cm, in ABS cromato.

# COLONNE DOCCIA CON PRESA ACQUA ESTERNA



## 330X 9MO UFM20 NRA

Set doccia composto da: deviatore con presa ad acqua 330NRA e flessibile a muro 50 cm, colonna doccia 329X con centralina, doccetta in ABS cromato anti-calcare a 4 funzioni 319MO, con flessibile in acciaio INOX da 150 cm, e soffione 357UFM20 ultrapiatto Ø 20 cm, in acciaio INOX lucidato a specchio.



## 330X 9MO EC20 NRA

Set doccia composto da: deviatore con presa ad acqua 330NRA e flessibile a muro 50 cm, colonna doccia 329X con centralina, doccetta in ABS cromato anti-calcare a 4 funzioni 319MO, con flessibile da 150 cm, e soffione 354EC20 ultrapiatto Ø 20 cm, in ABS cromato.



## 330X 8CP UFD20 NRA

Set doccia composto da: deviatore con presa ad acqua 330NRA e flessibile a muro 50 cm, colonna doccia 329X con centralina, doccetta in ABS cromato anti-calcare a 4 funzioni 318CP, con flessibile in acciaio INOX da 150 cm, e soffione 357UFD20 ultrapiatto 20x20 cm, in acciaio INOX lucidato a specchio.



## 330X 8CP AD20 NRA

Set doccia composto da: deviatore con presa ad acqua 330NRA e flessibile a muro 50 cm, colonna doccia 329X con centralina, doccetta in ABS cromato anti-calcare a 4 funzioni 318CP, con flessibile da 150 cm, e soffione 356AD20 ultrapiatto 20x20 cm, in ABS cromato.

BOX INCASSO

KIT WELLNESS

CROMOTERAPIA

BRACCI E SOFFIONI

PANNELLI DOCCIA

COLONNE DOCCIA

SALISCENDI

DOCCETTE

SHUT-OFF

KIT BORDO VASCA

BOCCHE

FLESSIBILI DOCCIA



## COLONNE DOCCIA TELESCOPICHE

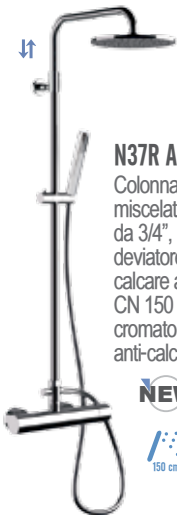

### N37R AMD20

Colonna doccia serie Minimal con miscelatore doccia attacco superiore da 3/4", colonna doccia telescopica con deviatore, doccetta in ABS cromato anti-calcare ad 1 funzione, con flessibile 333 CN 150 cm e soffione a pioggia, in ABS cromato, Ø 20 cm, con getti in silicone anti-calcare.

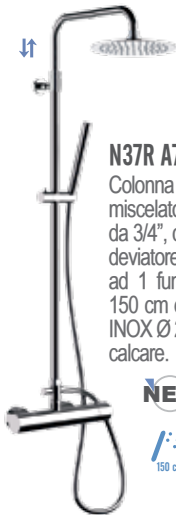

### N37R A7MM UFM20

Colonna doccia serie Minimal con miscelatore doccia e attacco superiore da 3/4", colonna doccia telescopica con deviatore, doccetta in ottone cromato ad 1 funzione, con flessibile 333 CN 150 cm e soffione a pioggia, in acciaio INOX Ø 20 cm, con getti in silicone anti-calcare.



### W37A MD20

Colonna doccia serie Winner con miscelatore doccia e attacco superiore da 3/4", colonna doccia telescopica con deviatore, doccetta in ABS cromato a 4 funzioni con getti anti-calcare, con flessibile 333 CN 150 cm e soffione a pioggia, in ABS cromato, Ø 20 cm, con getti in silicone anti-calcare.



### W37A UFM20

Colonna doccia serie Winner con miscelatore doccia e attacco superiore da 3/4", colonna doccia telescopica con deviatore, doccetta in ABS cromato a 4 funzioni con getti anti-calcare, con flessibile 333 CN 150 cm e soffione a pioggia, in acciaio INOX cromato, Ø 20 cm, con getti in silicone anti-calcare.



### I37A 7RV 54QI

Colonna doccia serie Infinity con miscelatore doccia e attacco superiore da 3/4", colonna doccia telescopica con deviatore, doccetta in ABS cromato anti-calcare a 1 funzione con deviatore, flessibile 333 CNX 150 cm e soffione quadrato con angoli arrotondati in ABS cromato 20x20 cm, con getti in silicone autopulenti ed anti-calcare.



### V37A 5P3 AD20

Colonna doccia serie Vanity con miscelatore doccia e attacco superiore da 3/4", colonna doccia telescopica con deviatore, in ABS cromato doccetta a 4 funzioni con getti anti-calcare, con flessibile 333 CN 150 cm e soffione a pioggia, quadrato con angoli arrotondati in abs cromato, 20x20 cm, con getti in silicone anti-calcare.





BOX INCASSO

KIT WELLNESS

CROMOTERAPIA

BRACCI E SOFFIONI

PANNELLI DOCCIA

COLONNE DOCCIA

SALISCENDI

DOCCETTE

SHUT-OFF

KIT BORDO VASCA

BOCCHE

FLESSIBILI DOCCIA

## COLONNE DOCCIA QUADRATE



### Q 37

Miscelatore esterno doccia Q 35 con colonna doccia quadra con saliscendi e deviatore, doccetta in ABS cromato anti-calcare 317 SQ e soffione completamente in ottone 359 SS. Flessibile in ottone cromato incluso.



### Q 37 XL

Miscelatore esterno doccia Q 35 con colonna doccia quadra, con saliscendi e deviatore, doccetta in ABS cromato 317 SQ e soffione completamente in ottone cromato 359 SS XL. Flessibile in ottone cromato incluso.



### 330W7 RRSS SRA

Colonna doccia extralusso barra rettangolare completa di saliscendi, deviatore, flessibile doccia, doccetta e soffione completamente in ottone cromato e anti-calcare, articoli 317RR e 359SS. A completamento dell'installazione la presa acqua/attacco a muro quadrato art 330SRA.



### Q 36

Set doccia composto da: Miscelatore esterno doccia Q35 con colonna doccia quadra con soffione completamente in ottone cromato e anti-calcare 359SS 20x20 cm.



## COLONNE DOCCIA TERMOSTATICHE QUADRATE



### ST31 317Q 317DS

Kit doccia composto da miscelatore esterno doccia termostatico quadrato ST31, saliscendi lusso ultrapiatto in ottone cromato 317Q, doccetta in abs cromata 317DS e flessibile 333CN 150 cm.



### ST32 S7DS 56S

Colonna doccia quadrata con miscelatore doccia termostatico con deviatore integrato, attacco superiore da 3/4", colonna doccia in ottone cromato e doccetta in ABS ad 1 funzione, con flessibile 333 CN 150 cm e soffione a snodo in ABS cromato Art. 356S 23x23 cm, con getti effetto pioggia in silicone, anti-calcare.



### ST31L 317Q 317SQ

Kit doccia composto da miscelatore esterno doccia termostatico quadrato tipo lusso ST31L, saliscendi lusso ultrapiatto in ottone cromato 317Q, doccetta anti-calcare con getti in silicone 317SQ e flessibile 333CN 150 cm.



### ST32LS 7SQ UFS20

Colonna doccia quadrata con miscelatore doccia termostatico con deviatore integrato, attacco superiore da 3/4", colonna doccia in ottone cromato e doccetta Qubika ad 1 funzione con getti in silicone, anti-calcare, flessibile 333 CN 150 cm e soffione ultra piatto 20x20 cm in acciaio INOX lucidato a specchio, con getti effetto pioggia in silicone, anti-calcare.



### QT 37

Miscelatore termostatico esterno doccia QT 35 con colonna doccia quadra, con saliscendi e deviatore, doccetta anti-calcare 317 SQ e soffione completamente in ottone cromato e anti-calcare 359 SS. Flessibile in ottone cromato incluso.



### QT 37 XL

Miscelatore termostatico esterno doccia QT 35 con colonna doccia quadra, con saliscendi e deviatore, doccetta anti-calcare 317 SQ e soffione completamente in ottone cromato e anti-calcare 359 SS XL. Flessibile in ottone cromato incluso.



### QT 36

Miscelatore termostatico esterno doccia QT 35 V con deviatore, flessibile e doccetta 317 RR, con colonna doccia quadra con soffione completamente in ottone cromato e anti-calcare 359SS.



### QT 36 XL

Miscelatore termostatico esterno doccia QT35V con deviatore, flessibile e doccetta in ottone 317RR, con colonna doccia quadra con soffione completamente in ottone cromato e anti-calcare 359SSXL.



### QT 37F XL

Miscelatore termostatico esterno doccia a corpo freddo QT32F con colonna doccia quadra con saliscendi e deviatore, doccetta anti-calcare 317SQ in ABS e soffione completamente in ottone cromato e anti-calcare 359SSXL 35x35 cm. Flessibile in ottone cromato incluso.

BOX INCASSO

KIT WELLNESS

CROMOTERAPIA

BRACCI E SOFFIONI

PANNELLI DOCCIA

COLONNE DOCCIA

SALISCENDI

DOCCETTE

SHUT-OFF

KIT BORDO VASCA

BOCCHE

FLESSIBILI DOCCIA





## COLONNE DOCCIA MINIMALI CON MISCELATORE



### N 37 B

Miscelatore esterno doccia N35 con colonna doccia minimale con saliscendi e deviatore, doccetta anti-calcare in abs cromato 317DM e soffione in abs cromato ed anti-calcare 356MD20 Ø 20 cm. Flessibile in ottone cromato incluso.



### N 37

Miscelatore esterno doccia N35 con deviatore integrato e colonna deluxe saliscendi girevole, completa di soffione anti-calcare 356LU, doccetta in abs cromato 317DM e flessibile in ottone.



### N 37 B XL

Miscelatore esterno doccia N35 con colonna doccia minimale con saliscendi e deviatore, doccetta anti-calcare in abs cromato 317DM e soffione in abs cromato ed anti-calcare 356MD25 Ø 25 cm. Flessibile in ottone cromato incluso.



### N 37 XL

Miscelatore esterno doccia N35 con deviatore integrato e colonna deluxe saliscendi girevole, completa di soffione 359MMXL in ottone anti-calcare, doccetta in abs cromato 317DM e flessibile in ottone.



### N 37 R

Miscelatore esterno doccia N35R con deviatore integrato e colonna deluxe saliscendi, completa di soffione anti-calcare 359MM20 Ø 20 cm, doccetta in Abs cromato 317DM e flessibile in ottone.



### N 37 RB

Miscelatore esterno doccia N35R con deviatore integrato e colonna minimal saliscendi girevole, completa di soffione anti-calcare in Abs cromato 356MD20 Ø 20 cm e doccetta anti-calcare in Abs cromato 317DM e flessibile in ottone.



**J 37 B**

Miscelatore esterno doccia J35 con colonna doccia minimale con saliscendi e deviatore, doccetta anti-calcare in abs cromato 317DM e soffione in abs cromato ed anti-calcare 356MD20 Ø 20 cm. Flessibile in ottone cromato incluso.

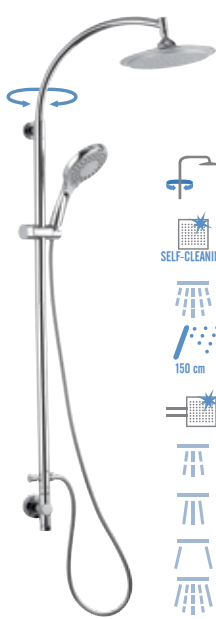

**330R 8DK 6LU RA**

Colonna doccia lusso minimale girevole completa di saliscendi, deviatore e flessibile doccia in ottone cromato. Inclusi doccetta 318DK anti-calcare e idromassaggio a 4 funzioni e soffione ultrapiatto anti-calcare art 356LU. A completamento dell'installazione la presa acqua-attacco a muro art. 330RA.

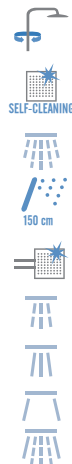

**J 37**

Miscelatore esterno doccia J35 con deviatore integrato, con colonna saliscendi girevole, completo di doccetta anti-calcare 317 MM in ottone cromato con flessibile e soffione 359 S25 in ottone cromato.



**37 LI**

Gruppo doccia con colonna saliscendi e deviatore, completa di doccetta 323CR con flessibile e soffione 359BE, tutto in ottone cromato.



BOX INCASSO

KIT WELLNESS

CROMOTERAPIA

BRACCI E SOFFIONI

PANNELLI DOCCIA

COLONNE DOCCIA

COLONNE DOCCIA FREESTANDING - COLONNE DOCCIA PER PISCINA



**331 SS**

Colonna doccia da esterno in acciaio INOX, monocomando a 2 vie con getto pioggia anti-calcare e getto cascata, acqua calda-fredda con attacco da pavimento,



**331 N2**

Colonna con miscelatore acqua calda-fredda saliscendi free-standing con attacco da pavimento, tutta in ottone cromato per doccia, spa, piscina etc, forma minimale rotonda, con deviatore, doccetta 317MM in ottone cromato e flessibile doccia cm 200, soffione anti-calcare in ottone cromato 359MM30 Ø cm 30.



**331 N52**

Colonna free-standing con miscelatore acqua calda-fredda, con attacco da pavimento tutta in ottone cromato per doccia, spa, piscina etc, forma minimale rotonda con soffione anti-calcare in ottone cromato 359MM30 Ø cm 30.



MONOACQUA



**331 N1**

Colonna saliscendi free-standing in ottone cromato con attacco da pavimento per doccia, spa, piscina etc, forma minimale rotonda, con comando monoacqua, deviatore, doccetta 317MM in ottone cromato e flessibile doccia cm 200, soffione anti-calcare in ottone cromato 359MM30 Ø cm 30.



**331 N51**

Colonna free-standing in ottone cromato con attacco da pavimento per doccia, spa, piscina etc, forma minimale rotonda, con comando monoacqua e soffione anti-calcare in ottone cromato 359MM30 Ø cm 30.



SALISCENDI

DOCCETTE

SHUT-OFF

KIT BORDO VASCA

BOCCHE

FLESSIBILI DOCCIA

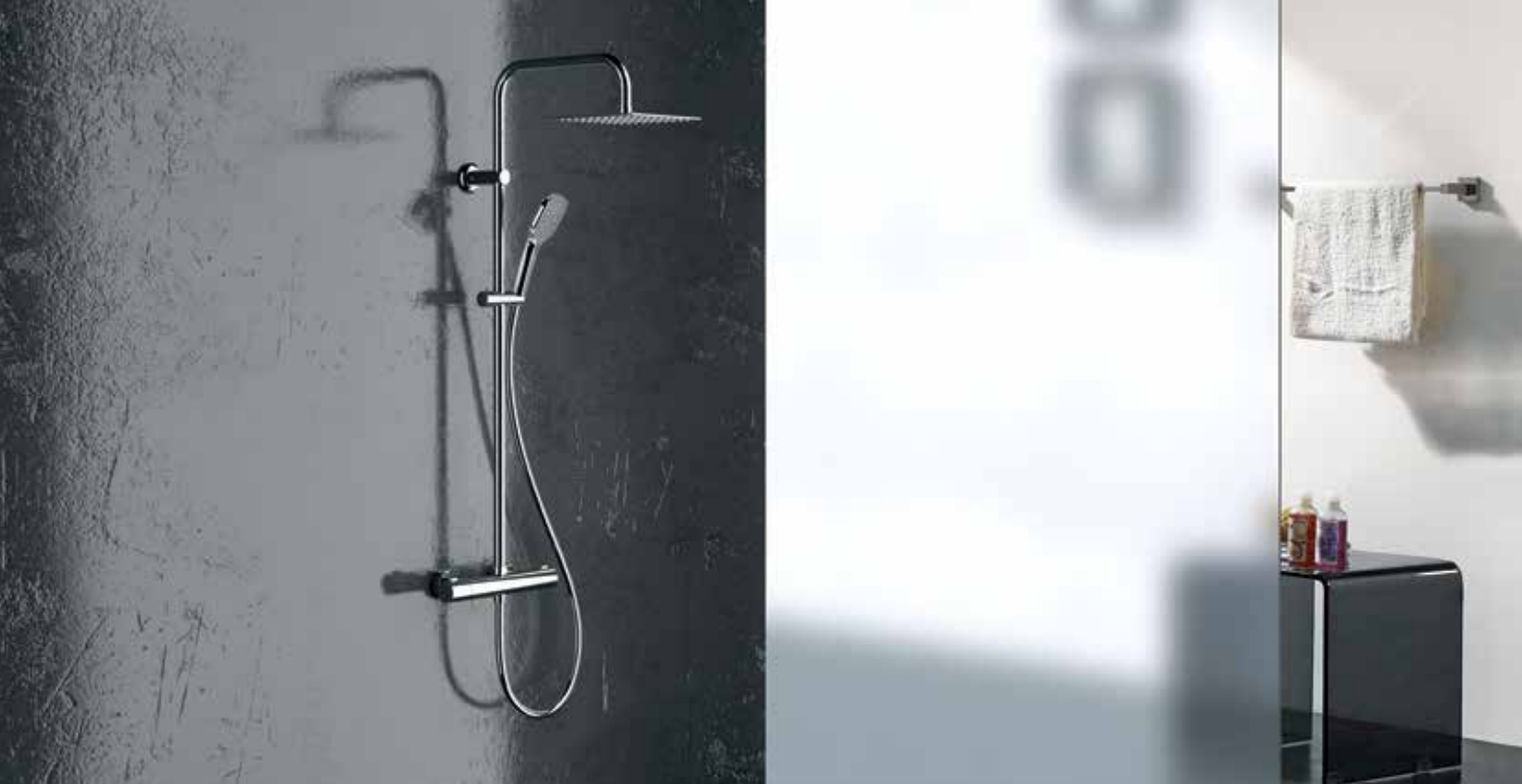

## COLONNE DOCCIA TERMOSTATICHE MINIMALI



### EQ32X UFM20

Miscelatore doccia termostatico con deviatore integrato, attacco superiore da 3/4", attacco inferiore da 1/2", colonna doccia minimale, doccetta anti-calcare a 4 funzioni, con flessibile 333 CNX 150 cm e soffione a pioggia, in acciaio INOX lucidato a specchio, Ø 20 cm, con getti in silicone anti-calcare.



### EQ32X EC20

Miscelatore doccia termostatico con deviatore integrato, attacco superiore da 3/4", attacco inferiore da 1/2", colonna doccia minimale, doccetta anti-calcare a 4 funzioni, con flessibile 333 CNX 150 cm e soffione ultrapiatto Ø 20 cm, in ABS cromato.



### EQ32X UFM25

Miscelatore doccia termostatico con deviatore integrato, attacco superiore da 3/4", attacco inferiore da 1/2", colonna doccia minimale, doccetta anti-calcare a 4 funzioni, con flessibile 333 CNX 150 cm e soffione lusso a pioggia, in acciaio INOX lucidato a specchio, Ø 25 cm, con getti in silicone anti-calcare.



### EQ32X MD20

Miscelatore doccia termostatico con deviatore integrato, attacco superiore da 3/4", attacco inferiore da 1/2", colonna doccia minimale, doccetta anti-calcare a 4 funzioni, con flessibile 333 CNX 150 cm e soffione ultrapiatto Ø 20 cm, in ABS cromato.



### EQ32X 8CP UFD20

Miscelatore doccia termostatico con deviatore integrato, attacco superiore da 3/4", attacco inferiore da 1/2", colonna doccia minimale, doccetta anti-calcare a 4 funzioni, con pulsante per il cambio dei getti e flessibile 333 CNX 150 cm e soffione a pioggia quadrato con angoli arrotondati, in acciaio INOX lucidato a specchio, con getti in silicone anti-calcare



### EQ32X 8CP AD20

Miscelatore doccia termostatico con deviatore integrato, attacco superiore da 3/4", attacco inferiore da 1/2", colonna doccia minimale, doccetta anti-calcare a 4 funzioni, con pulsante per il cambio dei getti e flessibile 333 CNX 150 cm e soffione a pioggia 20x20 cm con getti in silicone anti-calcare, in ABS cromato.



### EQ32X 8CP UFD25

Miscelatore doccia termostatico con deviatore integrato, attacco superiore da 3/4", attacco inferiore da 1/2", colonna doccia minimale, doccetta anti-calcare a 4 funzioni, con pulsante per il cambio dei getti e flessibile 333 CNX 150 cm e soffione a pioggia quadrato con angoli arrotondati, in acciaio INOX lucidato a specchio, 25x25 cm, con getti in silicone anti-calcare.



### EQ32X 8MP MD20

Miscelatore doccia termostatico con deviatore integrato, attacco superiore da 3/4", attacco inferiore da 1/2", colonna doccia minimale, doccetta anti-calcare a 4 funzioni, con pulsante per il cambio dei getti e flessibile 333 CNX 150 cm e soffione ultrapiatto 20x20cm, in ABS cromato.



### EQ 32 U

Miscelatore doccia termostatico con deviatore integrato, attacco superiore da 3/4", attacco inferiore da 3/4", colonna doccia minimale, doccetta minimale tonda, con flessibile 150 cm e soffione Ø 20 cm, in ABS cromato.

BOX INCASSO

KIT WELLNESS

CROMOTERAPIA

BRACCI E SOFFIONI

PANNELLI DOCCIA

COLONNE DOCCIA

SALISCENDI

DOCCETTE

SHUT-OFF

KIT BORDO VASCA

BOCCHE

FLESSIBILI DOCCIA



**EQ 37 330U**

Miscelatore termostatico esterno doccia EQ32 con colonna doccia deluxe con saliscendi e deviatore, doccetta anti-calcare in ottone cromato 317MM e soffione in abs cromato e anti-calcare 359MM20. Flessibile in ottone cromato incluso.



**EQ 37 330L**

Miscelatore termostatico esterno doccia EQ32 con colonna doccia con saliscendi e deviatore, doccetta anti-calcare in ottone cromato 317MM e soffione in abs cromato e anti-calcare 359MM20. Flessibile in ottone cromato incluso.

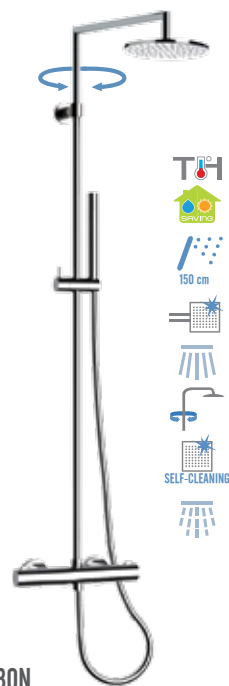

**EQ 37 330N**

Miscelatore termostatico esterno doccia EQ32 con colonna doccia minimale con saliscendi e deviatore, doccetta anti-calcare in abs cromato 317DM e soffione in abs cromato e anti-calcare 356MD25 Ø 25 cm. Flessibile in ottone cromato incluso.



**NT 37**

Miscelatore termostatico esterno doccia NT35 con colonna doccia deluxe con saliscendi e deviatore, doccetta anti-calcare in ottone cromato 317MM e soffione in ottone cromato e anti-calcare 359MM20 Ø 20 cm. Flessibile in ottone cromato incluso.



**NT 37 XL**

Miscelatore termostatico esterno doccia NT35 con colonna doccia deluxe con saliscendi e deviatore, doccetta anti-calcare in ottone cromato 317MM e soffione ultrapiatto in ottone cromato e anti-calcare 359MMXL Ø 35 cm. Flessibile in ottone cromato incluso.



**NT 37B**

Miscelatore termostatico esterno doccia NT35 con colonna doccia minimale con saliscendi e deviatore, doccetta anti-calcare in abs cromato 317DM e soffione in abs cromato e anti-calcare 356MD20 Ø 20 cm. Flessibile in ottone cromato incluso.

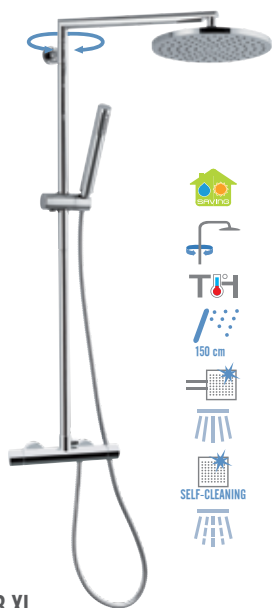

**NT 37B XL**

Miscelatore termostatico esterno doccia NT35 con colonna doccia minimale con saliscendi e deviatore, doccetta anti-calcare in abs cromato 317DM e soffione in abs cromato e anti-calcare 356MD25 Ø 25 cm. Flessibile in ottone cromato incluso.

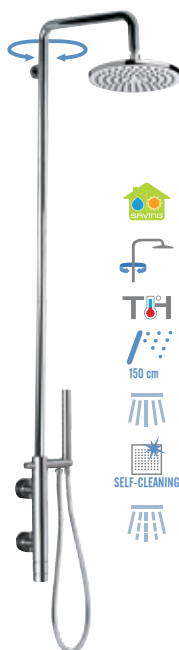

**NT 36**

Miscelatore termostatico verticale esterno doccia NT35V con colonna doccia deluxe con saliscendi e deviatore, doccetta anti-calcare in ottone cromato 317MM e soffione in ottone cromato e anti-calcare 359MM20 Ø 20 cm. Flessibile in ottone cromato incluso.

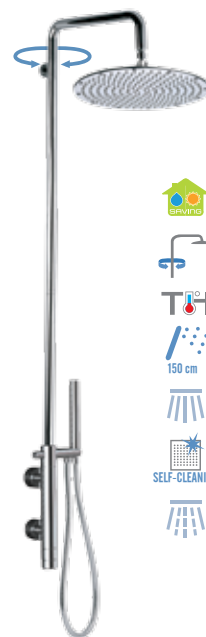

**NT 36 XL**

Miscelatore termostatico verticale esterno doccia NT35V con colonna doccia deluxe con saliscendi e deviatore, doccetta anti-calcare in ottone cromato 317MM e soffione ultrapiatto in ottone cromato e anti-calcare 359MMXL Ø 35 cm. Flessibile in ottone cromato incluso.



**NT 36B**

Miscelatore termostatico esterno doccia NT35V con colonna doccia minimale con saliscendi e deviatore, doccetta anti-calcare in abs cromato 317DM e soffione in abs cromato e anti-calcare 356MD20 Ø 20 cm. Flessibile in ottone cromato incluso.

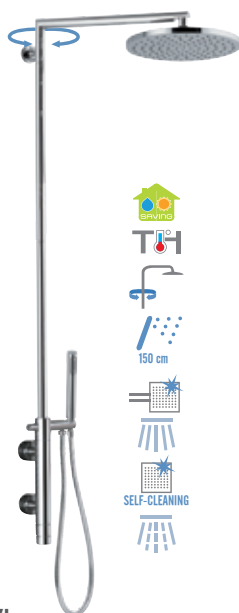

**NT 36B XL**

Miscelatore termostatico esterno doccia NT35V con colonna doccia minimale con saliscendi e deviatore, doccetta anti-calcare in abs cromato 317DM e soffione in abs cromato e anti-calcare 356MD25 Ø 25 cm. Flessibile in ottone cromato incluso.



**NT 37F XL**

Miscelatore termostatico a corpo freddo esterno doccia NT32F con colonna doccia deluxe con saliscendi e deviatore, doccetta anti-calcare in ottone cromato 317MM e soffione ultrapiatto in ottone cromato e anti-calcare 359MMXL Ø 35 cm. Flessibile in ottone cromato incluso.

BOX INCASSO

KIT WELLNESS

CROMOTERAPIA

BRACCI E SOFFIONI

PANNELLI DOCCIA

COLONNE DOCCIA

SALISCENDI

DOCCETTE

SHUT-OFF

KIT BORDO VASCA

BOCCHE

FLESSIBILI DOCCIA

**Colonna doccia termostatica a corpo freddo**





**330 STU 10**

Tubo in ottone cromato per estensione dell'altezza della colonna art. 329S e 330S, lunghezza cm 10 cm.



**330 STU 20**

Tubo in ottone cromato per estensione dell'altezza della colonna art. 329S e 330S, lunghezza cm 20 cm.



**330 FL BC**

Flessibile doccia per collegamento colonna doccia-miscelatore, attacco 1/2Fx1/2F, lunghezza cm 50.



**330 FTU 20**

Tubo in ottone cromato per estensione dell'altezza delle colonne 330F e 330L, lunghezza cm 20, Ø 22 mm.



**330 NTU 20**

Tubo in ottone cromato per estensione dell'altezza delle colonne art. 330N lunghezza cm 20, Ø 25 mm.



**N 17 PROL 10**

Prolunga per Miscelatore da soffitto lunghezza 10 cm, Ø 35 mm, in ottone cromato modello N17, N17L, NR17, NR17L.

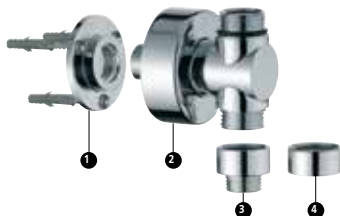

**330 RA**

Pres a d'acqua - supporto a muro per colonne doccia, multifunzione:  
 - supporto a muro alto  
 - presa d'acqua a muro alta  
 - presa d'acqua dal basso con tappo  
 - presa d'acqua dal basso per flessibile

Componenti:

1. Fissaggio a muro
2. Corpo principale
3. Riduzione 3/4Fx1/2M
4. Tappo 3/4F

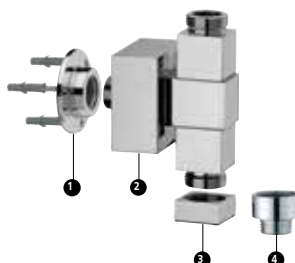

**330 S RA**

Pres a d'acqua - supporto a muro per colonne doccia, multifunzione:  
 - supporto a muro alto  
 - presa d'acqua a muro alta  
 - presa d'acqua dal basso con tappo  
 - presa d'acqua dal basso per flessibile

Componenti:

1. Fissaggio a muro
2. Corpo principale
3. Riduzione 3/4Fx1/2M
4. Tappo 3/4F

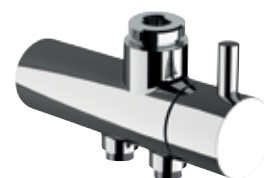

**330 N RA**

Supporto per colonne da 3/4 con deviatore integrato e presa acqua inferiore 1/2.



**330 DEV**

Deviatore con molla e fermo, per colonne, 3/4Mx3/4Fx1/2M.



**330 S DEV**

Deviatore con molla e fermo, per colonne, 3/4Mx3/4Fx1/2M.



**330 F SU**









Supporto inferiore per colonna da 3/4 con passaggio acqua esterno tramite collegamento 1/2.









































# COLONNE SENZA DOCCETTA

CODICE COLONNA

+

CODICE SOFFIONE

329 S 	329 W 	329 U 
329 R 	329 L 	329 F 
329 N 	329 A 	329 X 

359 SS XLX 35 x 35 cm  SXL	359 SSX 20 x 20 cm  9SS	359 WX 24 x 14 cm  59W
359 SS LX 30 x 30 cm  SSL	357 UF S20X 20 x 20 cm  FS20	357 UF S25X 25 x 25 cm  FS25
357 UF S30X 30 x 30 cm  FS30	357 UF S40X 40 x 40 cm  FS40	357 UFRX 33 x 22 cm  UFR
356 SD 20X 20 x 20 cm  NEW SD20	356 SD 25X 25 x 25 cm  NEW SD25	356 SD 30X 30 x 30 cm  NEW SD30
359 MM 20X Ø20 cm  M20	359 MM 30X Ø30 cm  M30	359 MM XLX Ø35 cm  MXL
356 MD 20X Ø20 cm  D20	356 MD 25X Ø25 cm  D25	356 MD 30X Ø30 cm  NEW D30
357 UF M20X Ø20 cm  FM20	357 UF M25X Ø25 cm  FM25	357 UF M30X Ø30 cm  FM30
357UF M40X Ø40 cm  FM40	356 V3X Ø23 cm  NEW 6V3	354 EC 20X Ø20 cm  NEW EC20
357 UF D20X 20 x 20 cm  NEW FD20	357 UF D25X 25 x 25 cm  NEW FD25	357 UF D30X 30 x 30 cm  NEW FD30
357 UF D40X 40 x 40 cm  NEW FD40	356 AD 20X 40 x 40 cm  NEW FD40	354 QIX 20 x 20 cm  4QI
356 REX 35 x 25 cm  6RE	356 SX 23 x 23 cm  56S	353 15X Ø15 cm  315
353 23X Ø25 cm  323	356 LUX Ø24 cm  6LU	359 BEX Ø10 cm  9BF
359 S25X Ø25 cm  S25	359 S18X Ø18 cm  S18	359 R15X Ø15 cm  R15
359 B20X Ø20 cm  B20		

BOX INCASSO

KIT WELLNESS

CROMOTERAPIA

BRACCI E SOFFIONI

PANNELLI DOCCIA

COLONNE DOCCIA

SALISCENDI

DOCCETTE

SHUT-OFF

KIT BORDO VASCA





















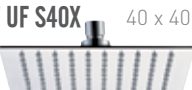



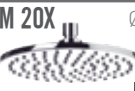
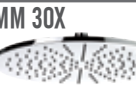

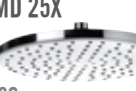

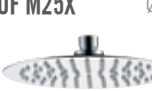







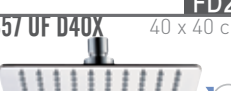









BOCCHIE

FLESSIBILI DOCCIA



















































# COLONNE CON DOCCETTA

CODICE COLONNA + FLESSIBILE +

CODICE SOFFIONE

<p><b>330 S</b></p> 	<p><b>330 W</b></p> 	<p><b>330 U</b></p> 	<p><b>359 SS XLX</b> 35 x 35 cm <b>SXL</b></p> 	<p><b>359 SSX</b> 20 x 20 cm <b>9SS</b></p> 	<p><b>359 WX</b> 24 x 14 cm <b>59W</b></p> 
			<p><b>359 SS LX</b> 30 x 30 cm <b>SSL</b></p> 	<p><b>357 UF S20X</b> 20 x 20 cm <b>FS20</b></p> 	<p><b>357 UF S25X</b> 25 x 25 cm <b>FS25</b></p> 
			<p><b>357 UF S30X</b> 30 x 30 cm <b>FS30</b></p> 	<p><b>357 UF S40X</b> 40 x 40 cm <b>FS40</b></p> 	<p><b>357 UFRX</b> 33 x 22 cm <b>UFR</b></p> 
			<p><b>356 SD 20X</b> 20 x 20 cm <b>NEW</b> <b>SD20</b></p> 	<p><b>356 SD 25X</b> 25 x 25 cm <b>NEW</b> <b>SD25</b></p> 	<p><b>356 SD 30X</b> 30 x 30 cm <b>NEW</b> <b>SD30</b></p> 
			<p><b>359 MM 20X</b> Ø20 cm <b>M20</b></p> 	<p><b>359 MM 30X</b> Ø30 cm <b>M30</b></p> 	<p><b>359 MM XLX</b> Ø35 cm <b>MXL</b></p> 
			<p><b>356 MD 20X</b> Ø20 cm <b>D20</b> € 36.90</p> 	<p><b>356 MD 25X</b> Ø25 cm <b>D25</b> € 59.80</p> 	<p><b>356 MD 30X</b> Ø30 cm <b>D30</b> € 94.30</p> 
			<p><b>357 UF M20X</b> Ø20 cm <b>FM20</b></p> 	<p><b>357 UF M25X</b> Ø25 cm <b>FM25</b></p> 	<p><b>357 UF M30X</b> Ø30 cm <b>FM30</b></p> 
			<p><b>357UF M40X</b> Ø40 cm <b>FM40</b></p> 	<p><b>356 V3X</b> Ø23 cm <b>NEW</b> <b>6V3</b></p> 	<p><b>354 EC 20X</b> Ø20 cm <b>NEW</b> <b>EC20</b></p> 
			<p><b>357 UF D20X</b> 20 x 20 cm <b>NEW</b> <b>FD20</b></p> 	<p><b>357 UF D25X</b> 25 x 25 cm <b>NEW</b> <b>FD25</b></p> 	<p><b>357 UF D30X</b> 30 x 30 cm <b>NEW</b> <b>FD30</b></p> 
			<p><b>357 UF D40X</b> 40 x 40 cm <b>NEW</b> <b>FD40</b></p> 	<p><b>356 AD 20X</b> 40 x 40 cm <b>NEW</b> <b>FD40</b></p> 	<p><b>354 QIX</b> 20 x 20 cm <b>4QI</b></p> 
			<p><b>356 REX</b> 35 x 25 cm <b>6RE</b></p> 	<p><b>356 SX</b> 23 x 23 cm <b>56S</b></p> 	<p><b>353 15X</b> Ø15 cm <b>315</b></p> 
			<p><b>353 23X</b> Ø25 cm <b>323</b></p> 	<p><b>356 LUX</b> Ø24 cm <b>6LU</b></p> 	<p><b>359 BEX</b> Ø10 cm <b>9BF</b></p> 
			<p><b>359 S25X</b> Ø25 cm <b>S25</b></p> 	<p><b>359 S18X</b> Ø18 cm <b>S18</b></p> 	<p><b>359 R15X</b> Ø15 cm <b>R15</b></p> 
			<p><b>359 B20X</b> Ø20 cm <b>B20</b></p> 		
<p><b>330 R</b></p> 	<p><b>330 L</b></p> 	<p><b>330 F</b></p> 			
<p><b>330 N</b></p> 	<p><b>330 A</b></p> 	<p><b>330 X</b></p> 			
<p><b>330 B</b></p> 					

CODICE DOCCETTA

311 DA <span style="float: right;">1F</span>  1DA	311 DA BI <span style="float: right;">1F</span>  DABI	311 MS <span style="float: right;">1F</span>  1MS	312 <span style="float: right;">1F</span>  312	312 HT <span style="float: right;">5F</span>  2HT
312 OV <span style="float: right;">3F</span>  2OV	312 RO <span style="float: right;">3F</span>  2RO	315 C1 <span style="float: right;">1F</span>  5C1	315 C3 <span style="float: right;">1F</span>  5C3	315 FO <span style="float: right;">3F</span>  5FO
315 ME <span style="float: right;">2F</span>  5ME	315 P3 <span style="float: right;">4F</span>  5P3	317 DM <span style="float: right;">1F</span>  7DM	317 DS <span style="float: right;">1F</span>  7DS	317 MM <span style="float: right;">1F</span>  7MM
317 MR <span style="float: right;">1F</span>  7MR	317 MT <span style="float: right;">1F</span>  7MT	317 RR <span style="float: right;">1F</span>  7RR	317 RV <span style="float: right;">1F</span>  7RV	317 SQ <span style="float: right;">1F</span>  7SQ
317 SS <span style="float: right;">1F</span>  7SS	317 TC <span style="float: right;">1F</span>  7TC	317 TH <span style="float: right;">1F</span>  7TH	317 TR <span style="float: right;">1F</span>  7TR	317 VP <span style="float: right;">1F</span>  7VP
318 CA <span style="float: right;">2F</span>  8CA	318 CP <span style="float: right;">1F</span>  8CP	318 DK <span style="float: right;">4F</span>  8DK	318 F4 <span style="float: right;">5F</span>  8F4	318 F5 <span style="float: right;">5F</span>  8F5
318 MP <span style="float: right;">4F</span>  8MP	318 R <span style="float: right;">3F</span>  18R	318 RL <span style="float: right;">3F</span>  8RL	318 V3 <span style="float: right;">3F</span>  8V3	318 XF <span style="float: right;">5F</span>  8XF
319 MO <span style="float: right;">4F</span>  9MO	319 WP <span style="float: right;">3F</span>  9WP	319 W1 <span style="float: right;">1F</span>  9W1	319 W3 <span style="float: right;">3F</span>  9W3	321 GR <span style="float: right;">4F</span>  1GR
321 HG <span style="float: right;">3F</span>  1HG	321 F5 <span style="float: right;">5F</span>  1F5	321 S <span style="float: right;">5F</span>  21S	321 SC <span style="float: right;">5F</span>  1SC	321 XL <span style="float: right;">4F</span>  1XL
323 CR <span style="float: right;">1F</span>  3CR	323 U <span style="float: right;">1F</span>  23U	324 <span style="float: right;">1F</span>  324	324 CR <span style="float: right;">1F</span>  4CR	324 ECR <span style="float: right;">1F</span>  ECR

BOX INCASSO

KIT WELLNESS

CROMOTERAPIA

BRACCI E SOFFIONI

PANNELLI DOCCIA

COLONNE DOCCIA

SALISCENDI

DOCCETTE

SHUT-OFF

KIT BORDO VASCA

BOCCHIE

FLESSIBILI DOCCIA



# SALISCENDI





BOX INCASSO

KIT WELLNESS

CROMOTERAPIA

BRACCI E SOFFIONI

PANNELLI DOCCIA

COLONNE DOCCIA

SALISCENDI

DOCCETTE

SHUT-OFF

KIT BORDO VASCA

BOCCHE

FLESSIBILI DOCCIA



<b>SIMBOLOGIE:</b>	 Doccetta Anti-calcare	 Con portasapone	 Con Doccetta	 Con flessibile 150, 200 cm	<b>NEW</b> Prodotto novità				
<b>GETTI DOCCETTE:</b>	 Posizione d'interruzione getto	 Getto intenso esterno con getto effetto pioggia internamente	 Getto con massaggio intenso a risparmio idrico	 Massaggio vigoroso ampia copertura effetto pioggia	 Getto Esterno	 Ampio getto pioggia a risparmio idrico	 Getto spray delicato ad ampia copertura con getto vigoroso all'esterno a risparmio idrico	 Getto a cascata	
	 Getto effetto pioggia	 Massaggio con getto vigoroso concentrato	 Getto aerato intenso	 Getto ad ampia copertura effetto pioggia	 Getto vigoroso ad ampia copertura effetto pioggia	 Massaggio con getto vigoroso ed ampio	 Pioggia soft a risparmio idrico	 Getto soft aerato mischiato ad un getto vigoroso a risparmio idrico	 Getto vigoroso concentrato e getto esterno

## SALISCENDI CON DOCCIA



### 311D 318F4

Saliscendi con doccetta cromata a 5 funzioni con getti in silicone, anti-calcare, flessibile 150 cm.



### 311D 318F5

Saliscendi con doccetta cromata a 5 funzioni con getti in silicone, anti-calcare, flessibile 150 cm.



### 317Q 317RR

Saliscendi e doccetta tutto in ottone serie ultrapiatta rettangolare minimale lusso, flessibile 150 cm.



### 315R 318MP

Saliscendi cromato con asta tonda minimale e doccetta cromata a 4 funzioni con pulsante per il cambio dei getti, con getti in silicone anti-calcare, flessibile 150 cm.

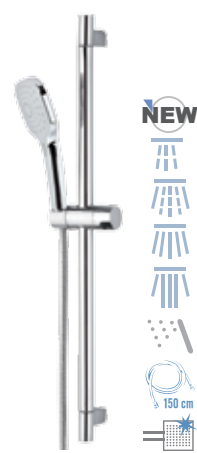

### 315R 318CP

Saliscendi cromato con asta tonda minimale e doccetta cromata a 4 funzioni con pulsante per il cambio dei getti, con getti in silicone, anti-calcare, flessibile 150 cm.



### 317V 315P3

Saliscendi cromato con asta minimale ovale, con doccetta anti-calcare a 4 funzioni, pulsante per il cambio dei getti anti-calcare in silicone, flessibile 150 cm.



### 317Q 319MO

Saliscendi in ottone cromato con asta ultrapiatta rettangolare e doccetta cromata minimale a 4 funzioni con getti in silicone, idromassaggio ed anti-calcare, flessibile 150 cm.



### 315R 319MO

Saliscendi cromato asta tonda, doccetta anti-calcare ed idromassaggio con getti in silicone a 4 funzioni e flessibile 150 cm.



### 317M 319MO

Saliscendi minimale con doccetta con idromassaggio a 4 funzioni, flessibile 150 cm.

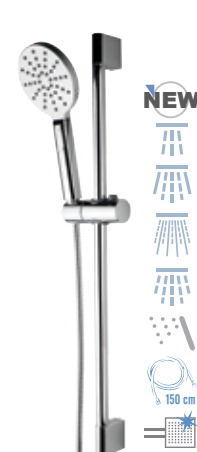

### 315L 318MP

Saliscendi minimale con doccetta a 4 funzioni con pulsante per il cambio dei getti, anti-calcare, flessibile 150 cm.



**311F 315P3**

Saliscendi cromato con asta tonda e doccetta cromata a 4 funzioni con pulsante per il cambio dei getti, con getti in silicone anti-calcare, flessibile 150 cm.

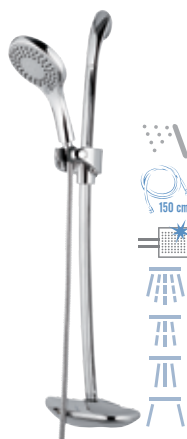

**313P 318DK**

Saliscendi cromato con asta ovale arcuata e portasapone design integrato, con doccetta anti-calcare con getti in silicone a 4 funzioni, flessibile 150 cm.



**313G 318CA**

Saliscendi cromato con asta orientabile e doccetta con getti in silicone anti-calcare a 2 funzioni con getto speciale a "cascata", flessibile 150 cm.

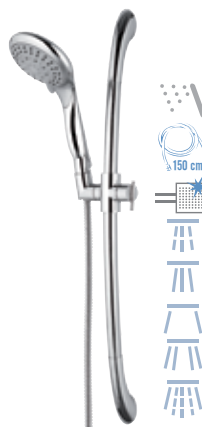

**310M 318XF**

Saliscendi cromato con asta tonda e con doccetta con getti in silicone anti-calcare con getti in silicone a 5 funzioni, flessibile 150 cm.



**317V 317RV**

Saliscendi cromato con asta minimale ovale dritta e doccetta con getti in silicone anti-calcare ovale, flessibile 150 cm.



**317R 317RR**

Saliscendi e doccetta tutto ottone serie ultrapiatta rettangolare minimale lusso, flessibile 150 cm.



**317S 317SS**

Saliscendi SQ con doccetta, tutto in ottone cromato, flessibile 150 cm.



**317G 319MO**

Saliscendi completamente in ottone cromato con asta tonda e doccetta con getti in silicone anti-calcare, idromassaggio minimale a 4 funzioni, flessibile 150 cm.

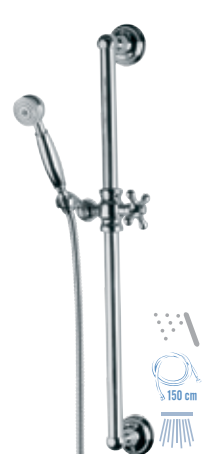

**317L 323CR**

Saliscendi Liberty lusso, completamente in ottone cromato, con asta tonda e doccetta in ottone cromato modello liberty, flessibile 150 cm.

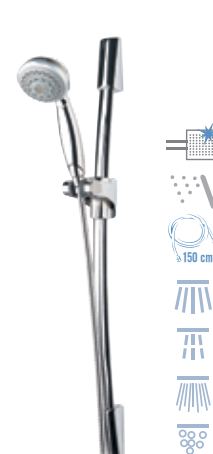

**313E 321GR**

Saliscendi con asta ovale curva e doccetta idromassaggio anti-calcare a 4 funzioni, flessibile 150 cm.



**317M 317DM**

Saliscendi minimale con doccetta anti-calcare, flessibile 150 cm.

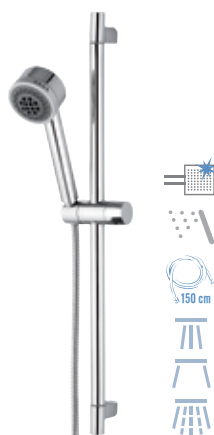

**315R 321HG**

Saliscendi cromato con asta tonda minimale e doccetta anti-calcare con getti in silicone anti-calcare e idromassaggio a 3 funzioni, flessibile 150 cm.



**315R 317MR**

Saliscendi cromato minimale con asta tonda e doccetta anti-calcare monogetto, flessibile 150 cm.



**310 318RL**

Saliscendi cromato con asta tonda e doccettona a disco a 3 funzioni con getti in silicone, idromassaggio e anti-calcare, flessibile 150 cm.



**317S 317SQ**

Saliscendi quadro in ottone cromato con doccetta minimale SQ in abs cromato e flessibile conico in ottone cromato cm 150.

BOX INCASSO

KIT WELLNESS

CROMOTERAPIA

BRACCI E SOFFIONI

PANNELLI DOCCIA

COLONNE DOCCIA

SALISCENDI

DOCCETTE

SHUT-OFF

KIT BORDO VASCA

BOCCHIE

FLESSIBILI DOCCIA

## WELLNESS: SALISCENDI

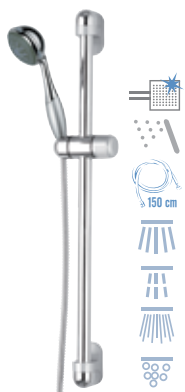

### 311S 321XL

Saliscendi cromo-satinato con asta tonda e doccetta cromo-satinata con getti in silicone a 4 funzioni, flessibile 150 cm.



### 311D 315C3

Saliscendi con doccetta idromassaggio anti-calcare ad 1 funzione, flessibile 150 cm.



### 311 311DA

Saliscendi con doccetta con getti in silicone ed anti-calcare, flessibile 150 cm.

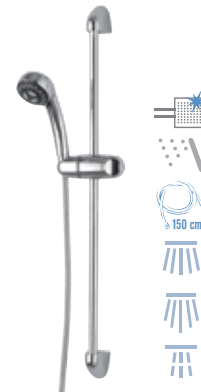

### 314 3120V

Saliscendi cromato con barra tonda fine e doccetta a 3 funzioni, con getti in silicone, idromassaggio ed anti-calcare, flessibile 150 cm.



### 313 318R

Saliscendi con asta ovale e doccetta cromata a 3 funzioni idromassaggio, anti-calcare, flessibile 150 cm.



### 310 321SC

Saliscendi cromato con asta tonda e doccetta anti-calcare a 5 funzioni, flessibile 150 cm.



### 311D 312

Saliscendi cromato con asta tonda e doccetta anti-calcare, flessibile 150 cm.

## SALISCENDI CM 60 CON PORTASAPONE /DISPENSER, ALCUNE COMBINAZIONI



### 312P 315FO

Saliscendi cromato accessoriato con doppio dispenser portasapone con doccetta anti-calcare a 3 funzioni, flessibile 150 cm.



### 319D 321GR

Saliscendi cm 90 con doccetta idromassaggio anti-calcare a 4 funzioni, flessibile 200 cm.



### 319F 318R

Saliscendi cm 90 con doccetta grande a disco idromassaggio, anti-calcare, a 3 funzioni, flessibile 200 cm.



### 319L 323U

Saliscendi Liberty Lusso cm 90, completamente in ottone cromato, con asta tonda e doccetta in ottone cromato modello liberty, flessibile 200 cm.

SALISCENDI CON DOCCIA CON DOPPIA POSIZIONE DI SUPPORTO DOCCIA

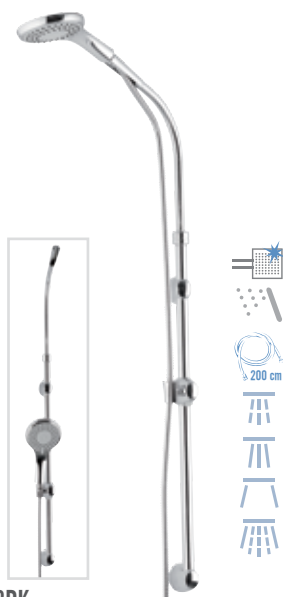

318C 318DK

Saliscendi cromato con doppia posizione di supporto doccia e braccio alto girevole e telescopico in ottone cromato, con doccetta anti-calcare a 4 funzioni, flessibile 200 cm.



318C 318RL

Saliscendi cromato con doppia posizione di supporto doccia e braccio alto girevole e telescopico in ottone cromato, con doccetta anti-calcare a 3 funzioni, flessibile 200 cm.

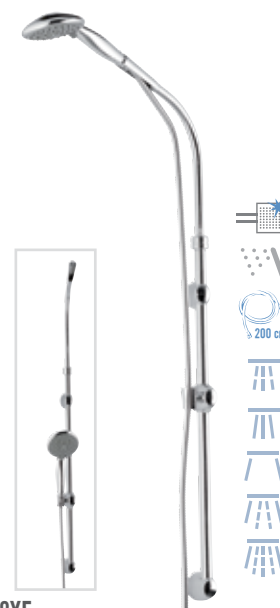

318C 318XF

Saliscendi cromato con doppia posizione di supporto doccia e braccio alto girevole e telescopico in ottone cromato, con doccetta anti-calcare a 5 funzioni, flessibile 200 cm.



318C 317TH

Saliscendi cromato con doppia posizione di supporto doccia e braccio alto girevole e telescopico in ottone cromato, con doccetta anti-calcare torch, flessibile 200 cm.



318C 317DM

Saliscendi cromato con doppia posizione di supporto doccia e braccio alto girevole e telescopico in ottone cromato, con doccetta anti-calcare minimal, flessibile 200 cm.

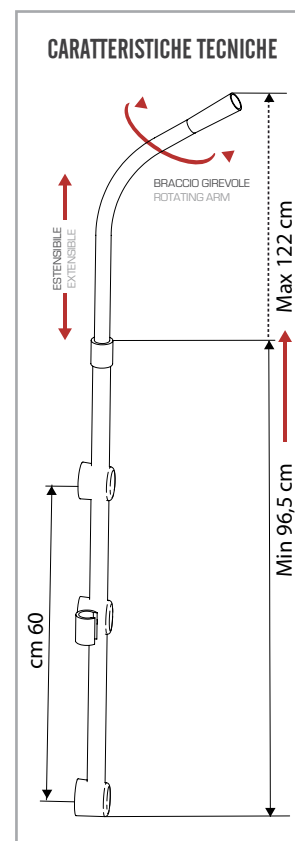

BOX INCASSO

KIT WELLNESS

CROMOTERAPIA

BRACCI E SOFFIONI

PANNELLI DOCCIA

COLONNE DOCCIA

SALISCENDI

DOCCETTE

SHUT-OFF

KIT BORDO VASCA

BOCCHIE

FLESSIBILI DOCCIA

TABELLA ABBINAMENTI SALISCENDI IN SCATOLA CON FINESTRA



CODICE SALISCENDI

+

310  Ø 25 mm	310 M  Ø 25 mm	311  Ø 25 mm	311 D  Ø 25 mm	311 F  Ø 25 mm	311 S  Ø 25 mm	315 L  NEW Ø 22 mm	312 P  Ø 25 mm
--------------------	----------------------	--------------------	----------------------	----------------------	----------------------	-----------------------------	----------------------

313  ovale	313 E  ovale	313 G  ovale	313 P  ovale	314  Ø 18 mm	315 R  NEW Ø 25 mm	317 G  Ø 25 mm
------------------	--------------------	--------------------	--------------------	--------------------	-----------------------------	----------------------

317 L  Ø 25 mm	317 M  Ø 18 mm	317 N  Ø 25 mm	317 R  30x10 mm	317 Q  NEW 30x15 mm	317 S  20x20 mm	317 V  ovale
----------------------	----------------------	----------------------	-----------------------	------------------------------	-----------------------	--------------------

ASTA SALISCENDI cm 90

319 G  90 cm Ø 25 mm	319 D  90 cm Ø 25 mm	319 F  90 cm Ø 25 mm	319 L  90 cm Ø 25 mm	319 R  NEW 90 cm Ø 25 mm	318 C  MAX 22 cm MIN 96 cm Ø 25 mm
-------------------------------	-------------------------------	-------------------------------	-------------------------------	--------------------------------------	--

311 DA  1F	311 DA BI  1F
312 OV  3F	312 RO  3F
315 ME  2F	315 P3  4F
317 MR  1F	317 MT  1F
317 SS  1F	317 TC  1F
318 CA  2F	318 CP  1F
318 MP  4F	318 R  3F
319 MO  4F	319 WP  3F
321 GR  4F	321 HG  3F
323 CR  1F	323 U  1F



## CODICE DOCCETTE

311 MS 1F	312 1F	312 HT 5F
315 C1 1F	315 C3 1F	315 FO 3F
317 DM 1F	317 DS 1F	317 MM 1F
317 RR 1F	317 RV 1F	317 SQ 1F
317 TH 1F	317 TR 1F	317 VP 1F
318 DK 4F	318 F4 5F	318 F5 5F
318 RL 3F	318 V3 3F	318 XF 5F
319 W1 1F	319 W3 3F	321 F5 5F
321 S 5F	321 SC 5F	321 XL 4F
324 1F	324 CR 1F	324 EGR 1F

+

## PORTASAPONE

+

## FLESSIBILE

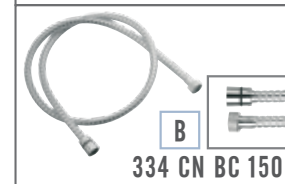
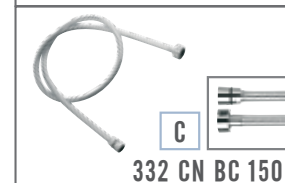
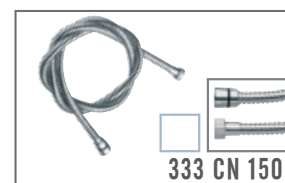
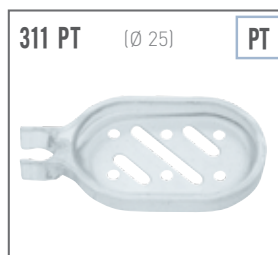

BOX INCASSO

KIT WELLNESS

CROMOTERAPIA

BRACCI E SOFFIONI

PANNELLI DOCCIA

COLONNE DOCCIA

SALISCENDI

DOCCETTE

SHUT-OFF

KIT BORDO VASCA

BOCCHIE

FLESSIBILI DOCCIA

ASTA IN OTTONE CROMATO



**313P 333**

Saliscendi cromato con asta ovale arcuata, e portasapone design integrato con flessibile senza doccetta, in scatola con finestra.



**313G 333**

Saliscendi cromato con asta orientabile, con flessibile senza doccetta, in scatola con finestra.



**310M 333**

Saliscendi cromato con asta tonda arcuata, con flessibile senza doccetta, in scatola con finestra.



**313E 333**

Saliscendi cromato con asta ovale arcuata, con flessibile, senza doccetta, in scatola con finestra.



**317V 333**

Saliscendi cromato con asta minimale ovale dritta, con flessibile senza doccetta, in scatola con finestra.



**313 333**

Saliscendi cromato con asta ovale, con flessibile, senza doccetta, in scatola con finestra.



**317M 333**

Saliscendi in ottone cromato con asta tonda minimale Ø mm 18, con flessibile, senza doccetta, in scatola con finestra.



**NEW**



**315R 333**

Saliscendi in ottone cromato con asta tonda minimale Ø 25 mm, con flessibile, senza doccetta, in scatola con finestra.



**NEW**



**315L 333**

Saliscendi cromato con asta tonda minimale Ø 22 mm, con flessibile, senza doccetta, in scatola con finestra.



**310 333**

Saliscendi cromato con asta tonda Ø 25 mm, con flessibile, senza doccetta, in scatola con finestra.



**311F 333**

Saliscendi cromato con asta tonda Ø 25 mm, con flessibile, senza doccetta, in scatola con finestra.



**311S 333**

Saliscendi cromo-satinato con asta tonda Ø 25 mm, con flessibile, senza doccetta, in scatola con finestra.



**311D 333**

Saliscendi cromato con asta tonda Ø 25 mm, con flessibile, senza doccetta, in scatola con finestra.



**311 333**

Saliscendi cromato con asta tonda Ø 25 mm, con flessibile, senza doccetta, in scatola con finestra.



**314 333**

Saliscendi cromato con asta tonda Ø 18 mm, con flessibile, senza doccetta, in scatola con finestra.

## TUTTO IN OTTONE

## WELLNESS



SUPPORTO  
REGOLABILE

**317G 333**

Saliscendi lusso in ottone cromato, asta tonda Ø mm 25, con flessibile, senza doccetta, in scatola con finestra.



SUPPORTO  
REGOLABILE

**317N 333**

Saliscendi lusso in ottone cromato, asta tonda Ø mm 25, con flessibile, senza doccetta, in scatola con finestra.



**317L 333**

Saliscendi Liberty lusso, in ottone cromato, asta tonda Ø mm 25, con flessibile, senza doccetta, in scatola con finestra.



**317R 333**

Saliscendi lusso Flat ultrapiatto, in ottone cromato, asta rettangolare piatta larga mm 30, con flessibile, senza doccetta, in scatola con finestra.



**317S 333**

Saliscendi completamente in ottone cromato da barra quadrata, linea SQ, con flessibile, senza doccetta, in scatola con finestra.



NEW

**317Q 333**

Saliscendi completamente in ottone cromato, ultrapiatto rettangolare minimale lusso, con flessibile, senza doccetta, in scatola con finestra.

BOX INCASSO

KIT WELLNESS

CROMOTERAPIA

BRACCI E SOFFIONI

PANNELLI DOCCIA

COLONNE DOCCIA

SALISCENDI

DOCCETTE

SHUT-OFF

KIT BORDO VASCA

BOCCHIE

FLESSIBILI DOCCIA



**319D 333**

Saliscendi lungo cromato con asta tonda Ø mm 25, lunghezza extra, con flessibile cm 200, senza doccetta, in scatola con finestra.



**319F 333**

Saliscendi lungo cromato con asta tonda Ø mm 25, lunghezza extra, con flessibile cm 200, senza doccetta, in scatola con finestra.



SUPPORTO  
REGOLABILE

**319G 333**

Saliscendi lusso in ottone cromato, asta tonda Ø mm 25, con flessibile, senza doccetta, in scatola con finestra.



**319L 333**

Saliscendi Liberty lusso extra lungo, completamente in ottone cromato, asta tonda Ø mm 25, lunghezza extra, con flessibile cm 200, senza doccetta, in scatola con finestra.



**319R 333**

Saliscendi in ottone cromato con asta tonda minimale Ø mm 25, con flessibile, senza doccetta, in scatola con finestra.



**318C 333**

Saliscendi cromato con doppia posizione di supporto doccia su centrale scorrevole e su braccio alto girevole in ottone cromato, completo con flessibile doccia da cm 200.



**312P 333**

Saliscendi cromato cm 60 con asta tonda Ø mm 25 accessorizzato con doppio dispenser portasapone con a fissaggio a muro, con flessibile, senza doccetta, in scatola con finestra.



# DOCETTE





BOX INCASSO

KIT WELLNESS

CROMOTERAPIA

BRACCI E SOFFIONI

PANNELLI DOCCIA

COLONNE DOCCIA

SALISCENDI

**DOCCETTE**

SHUT-OFF

KIT BORDO VASCA

BOCCHIE

FLESSIBILI DOCCIA



**SIMBOLOGIE:**



Doccetta Anti-calcare



Con Luce Led



Prodotto novità

**GETTI DOCCETTE:**



Getto intenso esterno con getto effetto pioggia internamente



Posizione d'interruzione getto



Getto con massaggio intenso a risparmio idrico



Massaggio vigoroso ampia copertura effetto pioggia



Getto Esterno



Ampio getto pioggia a risparmio idrico



Getto spray delicato ad ampia copertura con getto vigoroso all'esterno a risparmio idrico



Getto a cascata



Getto effetto pioggia



Massaggio con getto vigoroso concentrato



Getto vigoroso concentrato e getto esterno



Getto aerato intenso



Getto vigoroso ad ampia copertura effetto pioggia



Getto ad ampia copertura effetto pioggia



Massaggio con getto vigoroso ed ampio



Pioggia soft a risparmio idrico



Getto soft aerato misciato ad un getto vigoroso a risparmio idrico

**318 V3**

Doccetta cromata a 3 funzioni, pulsante per il cambio dei getti, con getti in silicone, anti-calcare.

SENZA SCATOLA	CON SCATOLA
318 V3	318 V3X

**321 F5**

Doccetta cromata a 4 funzioni, con getti in silicone, anti-calcare.

SENZA SCATOLA	CON SCATOLA
321 F5	321 F5X

**318 MP**

Doccetta cromata a 4 funzioni, pulsante per il cambio dei getti, con getti in silicone, anti-calcare.

SENZA SCATOLA	CON SCATOLA
318 MP	318 MPX

**315 P3**

Doccetta cromata a 4 funzioni, pulsante per il cambio dei getti, con getti in silicone, anti-calcare.

SENZA SCATOLA	CON SCATOLA
315 P3	315 P3X

**311 MS**

Doccetta satinata con getti in silicone, anti-calcare.

SENZA SCATOLA	CON SCATOLA
311 MS	311 MSX

**312**

Doccetta cromata con getti in silicone, anti-calcare.

SENZA SCATOLA	CON SCATOLA
312	312 X

**312 HT**

Doccetta idromassaggio anti-calcare a 5 funzioni.

SENZA SCATOLA	CON SCATOLA
312 HT	312 HTX

**312 OV**

Doccetta idromassaggio anti-calcare a 3 funzioni.

SENZA SCATOLA	CON SCATOLA
312 OV	312 OVX

**312 RO**

Doccetta idromassaggio anti-calcare a 3 funzioni.

SENZA SCATOLA	CON SCATOLA
312 RO	312 ROX

**315 C1**

Doccetta idromassaggio anti-calcare.

SENZA SCATOLA	CON SCATOLA
315 C1	315 C1X

**315 C3**

Doccetta idromassaggio anti-calcare.

SENZA SCATOLA	CON SCATOLA
315 C3	315 C3X

**315 FO**

Doccetta autopulente anti-calcare a 3 funzioni.

SENZA SCATOLA	CON SCATOLA
315 FO	315 FOX

**315 ME**

Doccetta idromassaggio anti-calcare a 2 funzioni.

SENZA SCATOLA	CON SCATOLA
315 ME	315 MEX

**319 WP**

Doccetta bianca e cromata a 3 funzioni con pulsante per il cambio dei getti e getti in silicone, anti-calcare.

SENZA SCATOLA	CON SCATOLA
319 WP	319 WPX

**319 W3**

Doccetta bianca e cromata a 3 funzioni con getti in silicone ed anti-calcare.

SENZA SCATOLA	CON SCATOLA
319 W3	319 W3X

**319 W1**



Doccetta bianca e cromata ad 1 funzione con getti in silicone ed anti-calcare.



SENZA SCATOLA	CON SCATOLA
319 W1	319 W1X

**318 CP**



Doccetta cromata a 4 funzioni con pulsante per il cambio dell'intensità del getto, con getti anti-calcare in silicone.



SENZA SCATOLA	CON SCATOLA
318 CP	318 CPX

**318 F4**



Doccetta cromata a 5 funzioni con getti in silicone, anti-calcare.



SENZA SCATOLA	CON SCATOLA
318 F4	318 F4X

**318 F5**



Doccetta cromata a 5 funzioni con getti in silicone, anti-calcare.



SENZA SCATOLA	CON SCATOLA
318 F5	318 F5X

**317 DM**



Doccetta minimal ad 1 funzione, anti-calcare con getti in silicone.



SENZA SCATOLA	CON SCATOLA
317 DM	317 DMX

**317 DS**



Doccetta quadrata ad 1 funzione serie SQ.



SENZA SCATOLA	CON SCATOLA
317 DS	317 DSX

**317 MM**



Doccetta Minimal ad 1 funzione completamente in ottone cromato.



SENZA SCATOLA	CON SCATOLA
317 MM	317 MMX

**317 SS**



Doccetta quadrata ad 1 funzione, in ottone cromato, serie SQ.



SENZA SCATOLA	CON SCATOLA
317 SS	317 SSX

**317 MT**



Doccetta "Triangle" ad 1 funzione, completamente in ottone cromato.



SENZA SCATOLA	CON SCATOLA
317 MT	317 MTX

**317 MR**



Doccetta cromata arcuata ad 1 funzione, con getti in silicone, anti-calcare.



SENZA SCATOLA	CON SCATOLA
317 MR	317 MRX

**317 RR**



Doccetta rettangolare serie Flat ultrapiatta, ad 1 funzione, in ottone cromato.



SENZA SCATOLA	CON SCATOLA
317 RR	317 RRX

**317 RV**



Doccetta cromata ovale ad 1 funzione con getti in silicone, anti-calcare.



SENZA SCATOLA	CON SCATOLA
317 RV	317 RVX

**317 SQ**



Doccetta cromata Qubika ad 1 funzione con getti in silicone, anti-calcare.



SENZA SCATOLA	CON SCATOLA
317 SQ	317 SQX

**319 MO**



Doccetta cromata minimale a 4 funzioni con getti in silicone, idromassaggio ed anti-calcare.



SENZA SCATOLA	CON SCATOLA
319 MO	319 MOX

**317 TC**



Doccetta "Triangle" cromata, ad 1 funzione con getti in silicone, anti-calcare.



SENZA SCATOLA	CON SCATOLA
317 TC	317 TCX

**317 TH**



Doccetta cromata "Torch" ad 1 funzione con getti in silicone, anti-calcare.



SENZA SCATOLA	CON SCATOLA
317 TH	317 THX

**317 TR**



Doccetta "Triangle" cromata-satinata ad 1 funzione con getti in silicone, anti-calcare.



SENZA SCATOLA	CON SCATOLA
317 TR	317 TRX

**317 VP**



Doccetta cromata "Palm" ad 1 funzione con getti in silicone, anti-calcare.



SENZA SCATOLA	CON SCATOLA
317 VP	317 VPX

**318 CA**



Doccetta cromata "cascata" a 2 funzioni, con innovativo getto a cascata, anti-calcare.



SENZA SCATOLA	CON SCATOLA
318 CA	318 CAX

**318 DK**



Doccetta cromata a 4 funzioni con getti in silicone, idromassaggio ed anti-calcare.



SENZA SCATOLA	CON SCATOLA
318 DK	318 DKX

BOX INCASSO

KIT WELLNESS

CROMOTERAPIA

BRACCI E SOFFIONI

PANNELLI DOCCIA

COLONNE DOCCIA

SALISCENDI

DOCCETTE

SHUT-OFF

KIT BORDO VASCA

BOCCHIE

FLESSIBILI DOCCIA

WELLNESS: DOCCETTE

**318 R**



Doccetta a disco con 3 funzioni, idromassaggio e anti-calcare.



SENZA SCATOLA	CON SCATOLA
318 R	318 RX

**318 RL**



Doccetta a disco con 3 funzioni, idromassaggio e anti-calcare.



SENZA SCATOLA	CON SCATOLA
318 RL	318 RLX

**318 XF**



Doccetta cromata a 5 funzioni con getti in silicone, idromassaggio ed anti-calcare.



SENZA SCATOLA	CON SCATOLA
318 XF	318 XFX

**321 HG**



Doccetta cromata minimale a 3 funzioni con getti in silicone, idromassaggio ed anti-calcare.



SENZA SCATOLA	CON SCATOLA
321 HG	321 HGX

**321 GR**



Doccetta idromassaggio anti-calcare a 4 funzioni.



SENZA SCATOLA	CON SCATOLA
321 GR	321 GRX

**321 SC**



Doccetta idromassaggio anti-calcare a 5 funzioni.



SENZA SCATOLA	CON SCATOLA
321 SC	321 SCX

**321 XL**



Doccetta idromassaggio, autopulente, anti-calcare a 4 funzioni.



SENZA SCATOLA	CON SCATOLA
321 XL	321 XLX

**323 CR**



Doccetta "Liberty" in ottone cromato.



SENZA SCATOLA	CON SCATOLA
323 CR	323 CRX

**323 U**



Doccetta "Futura" in ottone cromato.



SENZA SCATOLA	CON SCATOLA
323 U	323 UX

**311 DA**



Doccetta cromata con getti in silicone, anti-calcare.



SENZA SCATOLA	CON SCATOLA
311 DA	311 DAX

**311 DA BI**



Doccetta bianca con getti in silicone, anti-calcare.



SENZA SCATOLA	CON SCATOLA
311 DA BI	311 DA BIX

**324 CR**



Doccetta in plastica cromata.



SENZA SCATOLA
324 CR

**324 ECR**



Doccetta in plastica cromata.



SENZA SCATOLA
324 ECR

**324**



Doccetta in plastica bianca e nera "Rombo".



SENZA SCATOLA
324

## KIT SUPPORTO CON PRESA ACQUA E DOCCETTA

**337M 317MR**

Set doccia minimale composto da: presa acqua con supporto lusso in ottone cromato, doccetta cromata, anti-calcare con getti in silicone e flessibile 150 cm.

**337M 317DM**

Set doccia minimale composto da: presa acqua con supporto lusso in ottone cromato, doccetta cromata, anti-calcare con getti in silicone e flessibile 150 cm.

**337M 317MM**

Set doccia minimale composto da: presa acqua con supporto lusso in ottone cromato, doccetta in ottone cromato e flessibile 150 cm.

**337M 318MP**

Set doccia minimale composto da: presa acqua con supporto lusso in ottone cromato, doccetta cromata a 4 funzioni, con pulsante per cambio dei getti, anti-calcare con getti in silicone e flessibile 150 cm.

**337M 318F4**

Set doccia minimale composto da: presa acqua con supporto lusso in ottone cromato, doccetta cromata 5 funzioni, anti-calcare con getti in silicone e flessibile 150 cm.

**337M 319MO**

Set doccia minimale composto da: presa acqua con supporto lusso in ottone cromato, doccetta cromata 4 funzioni, idromassaggio, anti-calcare con getti in silicone e flessibile 150 cm.

**337Q 318CP**

Set doccia quadrato composto da: presa acqua con supporto lusso in ottone cromato, doccetta cromata a 4 funzioni, con pulsante per cambio dei getti, anti-calcare con getti in silicone e flessibile 150 cm.

**337Q 317SQ**

Set doccia Qubika composto da: presa acqua con supporto lusso in ottone cromato, doccetta cromata anti-calcare con getti in silicone e flessibile 150 cm.

**337Q 317SS**

Set doccia SQ composto da: presa acqua con supporto lusso in ottone cromato, doccetta in ottone cromato e flessibile 150 cm.

BOX INCASSO

KIT WELLNESS

CROMOTERAPIA

BRACCI E SOFFIONI

PANNELLI DOCCIA

COLONNE DOCCIA

SALISCENDI

DOCCETTE

SHUT-OFF

KIT BORDO VASCA

BOCCHIE

FLESSIBILI DOCCIA

## DOCCETTE CUCINA

**K66 DO NE**

Doccetta per parrucchiere, nera.



SENZA SCATOLA	CON SCATOLA
K66 DO NE	K66 DO NEX

**331**

Doccetta per monoforo lavello.



SENZA SCATOLA	CON SCATOLA
331	331 X

**331 K47**

Doccetta cromata per monoforo lavello.

CROMATA   BIANCA

SENZA SCATOLA	CON SCATOLA	SENZA SCATOLA	CON SCATOLA
331 K47	331 K47X	331 K47 BI	331 K47BIX

**331 N82**

Doccetta cromata per monoforo lavello, a due funzioni.



SENZA SCATOLA	CON SCATOLA
331 N82	331 N82X

**331 N82 C**

Doccetta cromata per monoforo lavello, a due funzioni.



SENZA SCATOLA	CON SCATOLA
331 N82 C	331 N82 CX

**331 N83 A**

Doccetta cromata per monoforo lavello, a due funzioni.



SENZA SCATOLA	CON SCATOLA
331 N 83 A	331 N 83 AX

**331 N83 B**

Doccetta cromata per monoforo lavello, a due funzioni.



SENZA SCATOLA	CON SCATOLA
331 N 83 B	331 N 83 BX

**331 DJN**

Doccetta cromata per monoforo lavello, ad due funzioni.



SENZA SCATOLA	CON SCATOLA
331 DJN	331 DJNX

**331 DJC**

Doccetta cromata per monoforo lavello, a due funzioni.



SENZA SCATOLA	CON SCATOLA
331 DJC	331 DJCX

**331 DJD**

Doccetta cromata per monoforo lavello, a due funzioni.



SENZA SCATOLA	CON SCATOLA
331 DJD	331 DJDX

**331 N85**

Doccetta cromata per monoforo lavello, a due funzioni.



SENZA SCATOLA	CON SCATOLA
331 N85	331 N85X

**331 N86**

Doccetta cromata per monoforo lavello, a due funzioni.



SENZA SCATOLA	CON SCATOLA
331 N86	331 N86X

**331 N87**

Doccetta cromata per monoforo lavello, a due funzioni.



SENZA SCATOLA	CON SCATOLA
331 N87	331 N87X

**331 N78**

Doccetta cromata per monoforo lavello, ad una funzione con pulsante di azionamento.



SENZA SCATOLA	CON SCATOLA
331 N78	331 N78X

**331 NR78**

Doccetta cromata per monoforo lavello, ad una funzione con luce led ed attacco da 1/2.



SENZA SCATOLA	CON SCATOLA
331 NR78	331 NR78X

**331 NR78 24**

Doccetta cromata per monoforo lavello, ad una funzione con luce led ed attacco da 24x1.



SENZA SCATOLA	CON SCATOLA
331 NR78 24	331 NR78 24X



PORTASAPONE

BOX INCASSO

KIT WELLNESS

CROMOTERAPIA

BRACCI E SOFFIONI

PANNELLI DOCCIA

COLONNE DOCCIA

SALISCENDI

DOCCETTE

SHUT-OFF

KIT BORDO VASCA

BOCCHIE

FLESSIBILI DOCCIA



**312 PS**  
Doppio dispenser per saliscendi ad asta tonda Ø 25 mm.



**319 PR**  
Portasapone cromato per saliscendi con asta tonda Ø 25.



**311 PC**  
Portasapone cromato economico per saliscendi tipo art. 310, 311 e 314, per asta Ø 25 mm e Ø 18 mm.



**311 PT**  
Portasapone trasparente economico per saliscendi tipo art. 310, 311 e 314, per asta Ø 25 mm e Ø 18 mm.



**311 PS**  
Portasapone per saliscendi art. 310 e 311, per asta Ø 24 o 25 mm.



**313 PO**  
Portasapone per saliscendi art. 313 per asta ovale.



**317 PM**  
Portasapone cromato per saliscendi con asta tonda Ø 18.

ACCESSORI PER DOCCETTE



**309**  
Angolo 1/2Mx1/2M in ottone cromato, con rosone scorrevole in ottone cromato.



**316 A**  
Deviatore doccia per canna livello Ø 18 mm 3/4Mx3/4Fx1/2M, tipo automatico con molla.



**309 L**  
Attacco presa acqua da 1/2, tipo rotondo pesante.



**309 S**  
Attacco presa acqua da 1/2Fx1/2M, tipo quadrato, pesante.



**309 NR**  
Raccordo doccia da 1/2" con valvola di non ritorno.



**309 RL6**  
Raccordo doccia 1/2" a risparmio idrico con limitatore di portata da 6 litri al minuto.



**309 RL8**  
Raccordo doccia 1/2" a risparmio idrico con limitatore di portata da 8 litri al minuto.



**333 CNX ES**  
Flessibile per doccia estensibile a doppia graffatura in acciaio INOX Ø 14 F.F., tubo in EPDM lunghezza cm 100, 120, 150, 175, con attacco conico.

- 333 CNX ES 100
- 333 CNX ES 120
- 333 CNX ES 150
- 333 CNX ES 175



**SHUT-OFF**





BOX INCASSO

KIT WELLNESS

CROMOTERAPIA

BRACCI E SOFFIONI

PANNELLI DOCCIA

COLONNE DOCCIA

SALISCENDI

DOCCETTE

SHUT-OFF

KIT BORDO VASCA

BOCCHE

FLESSIBILI DOCCIA

**SIMBOLOGIE:**

  
Con Kit Doccia e flessibile  
lungo: 120, 150 o 200 cm

  
Massaggio con getto  
vigoroso concentrato

  
Prodotto novità

**MISCELATORI INCASSO**



**N 63**  
Miscelatore incasso per  
shut-off.



**Z 63**  
Miscelatore incasso  
per shut-off.



**L 63**  
Miscelatore incasso per  
shut-off.



**Q 63**  
Miscelatore incasso per  
shut-off.



**S 63 3**  
Miscelatore incasso per  
shut-off.

**SHUT-OFF TERMOSTATICO**



  
  
  
  
120 cm  

**NT 60 W**  
Miscelatore incasso per shut-off comprensivo di: doccetta shut-off art 332 OW, supporto doccia- presa acqua su piastra in ottone cromato e flessibile doccia cm 120.

**SHUT-OFF PROGRESSIVO**



  
  
120 cm  

**N 64 W**  
Miscelatore shut-off con cartuccia progressiva, apertura su acqua fredda e passaggio ad acqua calda tramite rotazione di maniglia unica, comprensivo di doccetta shut-off art. 332OW e flessibile doccia cm 120.

**SHUT-OFF**



  
120 cm  

**D 60**  
Miscelatore incasso per shut-off comprensivo di: doccetta shut-off art. 332OL, supporto doccia- presa acqua su piastra in ottone cromato e flessibile doccia cm 120.



  
120 cm  

**N 60**  
Miscelatore incasso per shut-off comprensivo di: doccetta shut-off art 332OL, supporto doccia presa acqua su piastra in ottone cromato e flessibile doccia cm 120.



  
120 cm  

**I 60**  
Miscelatore incasso per shut-off comprensivo di: doccetta shut-off art. 332OL, supporto doccia- presa acqua su piastra in ottone cromato e flessibile doccia cm 120.



**D 60 W**

Miscelatore incasso per shut-off comprensivo di: doccetta shut-off art. 332OW, supporto doccia-presa acqua su piastra in ottone cromato e flessibile doccia cm 120.



**N 60 W**

Miscelatore incasso per shut-off comprensivo di: doccetta shut-off art. 332OW, supporto doccia-presa acqua su piastra in ottone cromato e flessibile doccia cm 120.



**I 60 W**

Miscelatore incasso per shut-off comprensivo di: doccetta shut-off art. 332OW, supporto doccia-presa acqua su piastra in ottone cromato e flessibile doccia cm 120.



**S 60 3**

Miscelatore incasso per shut-off comprensivo di: doccetta shut-off art. 332OS, supporto doccia-presa acqua su piastra in ottone cromato e flessibile doccia cm 120.



**Z 60**

Miscelatore incasso per shut-off comprensivo di: doccetta shut-off art. 332OS, supporto doccia-presa acqua su piastra in ottone cromato e flessibile doccia cm 120.



**Q 60**

Miscelatore incasso per shut-off comprensivo di: doccetta shut-off art. 332OS, supporto doccia-presa acqua su piastra in ottone cromato e flessibile doccia cm 120.



**W 65**

Miscelatore incasso per shut-off serie Winner comprensivo di doccetta shut-off art. 332OL, supporto doccia-presa acqua, attacco conico da 1/2" e supporto shut-off, tutto in ottone cromato, flessibile doccia cm 120.



**W 65 W**

Miscelatore incasso per shut-off serie Winner comprensivo di doccetta shut-off art. 332OW, supporto doccia-presa acqua, attacco conico da 1/2" e supporto shut-off, tutto in ottone cromato, flessibile doccia cm 120.



**W 65 B**

Miscelatore incasso per shut-off serie Winner su piastra in ottone cromato, attacco conico da 1/2" e supporto shut-off.



**I 65**

Miscelatore incasso per shut-off serie Infinity comprensivo di doccetta shut-off art. 332OL, supporto doccia-presa acqua, attacco conico da 1/2" e supporto shut-off, tutto in ottone cromato, flessibile doccia cm 120.



**I 65 W**

Miscelatore incasso per shut-off serie Infinity comprensivo di doccetta shut-off art. 332OW, supporto doccia-presa acqua, attacco conico da 1/2" e supporto shut-off, tutto in ottone cromato, flessibile doccia cm 120.



**I 65 B**

Miscelatore incasso per shut-off serie Infinity su piastra in ottone cromato, attacco conico da 1/2" e supporto shut-off.

BOX INCASSO

KIT WELLNESS

CROMOTERAPIA

BRACCI E SOFFIONI

PANNELLI DOCCIA

COLONNE DOCCIA

SALISCENDI

DOCCETTE

SHUT-OFF

KIT BORDO VASCA

BOCCHIE

FLESSIBILI DOCCIA





**L 65**

Miscelatore incasso per shut-off serie Class Line comprensivo di doccetta shut-off art. 332OL, supporto doccia-presa acqua, attacco conico da 1/2" e supporto shut-off, tutto in ottone cromato, flessibile doccia cm 120.



**L 65 W**

Miscelatore incasso per shut-off serie Class Line comprensivo di doccetta shut-off art. 332OW, supporto doccia-presa acqua, attacco conico da 1/2" e supporto shut-off, tutto in ottone cromato, flessibile doccia cm 120.



**L 65 B**

Miscelatore incasso per shut-off serie Class Line su piastra in ottone cromato, attacco conico da 1/2" e supporto shut-off.



**D 65**

Miscelatore incasso per shut-off serie Dream comprensivo di doccetta shut-off art. 332OL, supporto doccia-presa acqua, attacco conico da 1/2" e supporto shut-off, tutto in ottone cromato, flessibile doccia cm 120.



**D 65 W**

Miscelatore incasso per shut-off serie Dream comprensivo di doccetta shut-off art. 332OW, supporto doccia-presa acqua, attacco conico da 1/2" e supporto shut-off, tutto in ottone cromato, flessibile doccia cm 120.



**D 65 B**

Miscelatore incasso per shut-off serie Dream su piastra in ottone cromato, attacco conico da 1/2" e supporto shut-off.



**V 65 W**

Miscelatore incasso per shut-off serie Vanity comprensivo di doccetta shut-off art. 332OW, supporto doccia-presa acqua, attacco conico da 1/2" e supporto shut-off, tutto in ottone cromato, flessibile doccia cm 120.



**X 65**

Miscelatore incasso per shut-off serie X Style comprensivo di doccetta shut-off art. 332OW, supporto doccia-presa acqua, attacco conico da 1/2" e supporto shut-off, tutto in ottone cromato, flessibile doccia cm 120.



**Q 65**

Miscelatore incasso per shut-off serie Qubika comprensivo di doccetta shut-off art. 332OS, supporto doccia-presa acqua, attacco conico da 1/2" e supporto shut-off, tutto in ottone cromato, flessibile doccia cm 120.



**V 65 B**

Miscelatore incasso per shut-off serie Vanity su piastra in ottone cromato, attacco conico da 1/2" e supporto shut-off.



**X 65 B**

Miscelatore incasso per shut-off serie X Style su piastra in ottone cromato, attacco conico da 1/2" e supporto shut-off.



**Q 65 B**

Miscelatore incasso per shut-off serie Qubika su piastra in ottone cromato, attacco conico da 1/2" e supporto shut-off.



**N 65**  
Miscelatore incasso per shut-off serie Minimal comprensivo di doccetta shut-off art. 332OL, supporto doccia-presa acqua, attacco conico da 1/2" e supporto shut-off, tutto in ottone cromato, flessibile doccia cm 120.



**N 65 W**  
Miscelatore incasso per shut-off serie Minimal comprensivo di doccetta shut-off art. 332OW, supporto doccia-presa acqua, attacco conico da 1/2" e supporto shut-off, tutto in ottone cromato, flessibile doccia cm 120.



**N 65 SW**  
Miscelatore incasso per shut-off serie Minimal con leva corta, comprensivo di doccetta shut-off art. 332OW, supporto doccia-presa acqua, attacco conico da 1/2" e supporto shut-off, tutto in ottone cromato, flessibile doccia cm 120.



**N 65 B**  
Miscelatore incasso per shut-off serie Minimal su piastra in ottone cromato, attacco conico da 1/2" e supporto shut-off.



**N 10 SH**  
Miscelatore monocomando lavabo con doccetta shut-off 332OL e scarico click-clack con troppo pieno.



**L 10 SHW**  
Miscelatore monocomando lavabo con doccetta shut-off 332OW e scarico click-clack con troppo pieno.



**W 10 SHW**  
Miscelatore monocomando lavabo con doccetta shut-off 332OW e scarico click-clack con troppo pieno.



**Q 10 SH**  
Miscelatore monocomando lavabo con doccetta shut-off 332OS e scarico click-clack con troppo pieno.



**332 REL 336**  
Set composto da: doccia a pulsante 332OL, flessibile con attacco conico cm 120, rubinetto d'arresto con supporto doccia in ottone cromato.



**332 RES 336**  
Set composto da: doccia a pulsante quadrata 332OS, flessibile con attacco conico cm 120, rubinetto d'arresto con supporto doccia in ottone cromato.



**332 REW 336**  
Set quadrato composto da: doccia a pulsante 332OW, flessibile con attacco conico cm 120, rubinetto d'arresto con supporto doccia in ottone cromato.



**332 RELA 336**  
Set composto da: doccia a pulsante (compreso di aeratore e chiave 83AC), flessibile con attacco conico cm 120, rubinetto d'arresto con supporto doccia in ottone cromato.



**332 REZ 336**  
Set composto da: doccia a pulsante con impugnatura zigrinata 1/2", flessibile con attacco conico cm 120, rubinetto d'arresto, con supporto doccia in ottone cromato.



**332 REU 336**  
Set composto da: doccia a pulsante minimale in ABS cromata, flessibile con attacco conico cm 120, rubinetto d'arresto, con supporto doccia in ottone cromato.

BOX INCASSO

KIT WELLNESS

CROMOTERAPIA

BRACCI E SOFFIONI

PANNELLI DOCCIA

COLONNE DOCCIA

SALISCENDI

DOCCETTE

SHUT-OFF

KIT BORDO VASCA

BOCCHIE

FLESSIBILI DOCCIA



**LC 31 DP**

Miscelatore monocomando esterno doccia, interasse 100 mm, con kit composto da doccetta shut-off in abs cromato art. 332DPCR, flessibile conico in ottone cromato 120 cm e gancio cromato art. 332GA.



**IC31 REW**

Miscelatore monocomando esterno doccia, interasse 100 mm e kit composto da doccia a pulsante art 332OW, flessibile conico 120 cm e supporto art. 339SO in ottone cromato.



**WC 31 DP**

Miscelatore monocomando esterno doccia, interasse 100 mm, con kit composto da doccetta shut-off in abs cromato art. 332DPCR, flessibile conico in ottone cromato 120 cm e gancio cromato art. 332GA.

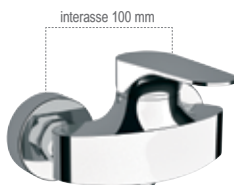

**LC 31**

Miscelatore monocomando esterno doccia, interasse 100 mm, senza kit doccia.

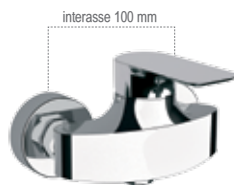

**IC 31**

Miscelatore monocomando esterno doccia, interasse 100 mm, senza kit doccia.



**WC 31**

Miscelatore monocomando esterno doccia, interasse 100 mm.



**C 332 REL**

Set "Relax" composto da: doccia a pulsante art 332OL, flessibile conico 120 cm, miscelatore doccia serie cento art. C33 interasse 100 mm e supporto "lux" in ottone cromato.



**C 332 REZ**

Set "Relax" composto da: doccia a pulsante art 332OZ, flessibile conico 120 cm, miscelatore doccia serie cento art C33 interasse 100 mm e supporto "lux" in ottone cromato.



**C 332 RELA**

Set "Relax" composto da: doccia a pulsante art 332OLA, flessibile conico 120 cm, miscelatore doccia serie cento art C33 interasse 100 mm e supporto "lux" in ottone cromato.

**332 RELA**

Set "Relax", composto da: doccia a pulsante art. 332OLA (compresa di aeratore e chiave 83AC), flessibile conico 120 cm, rubinetto sottolavabo "Minimal" con vitone ceramico e supporto "Lux" in ottone cromato.

**332 332 OLA**

Set "Relax", composto da: doccia a pulsante art. 332OLA (compresa di aeratore e chiave 83AC), flessibile conico 120 cm, supporto "Lux" in ottone cromato.

**332 REZ**

Set "Relax", composto da: doccia a pulsante art. 332OZ, flessibile conico 120 cm, rubinetto sottolavabo "Minimal" con vitone ceramico e supporto "Lux" in ottone cromato.

**332 332 OZ**

Set "Relax", composto da: doccia a pulsante art. 332OZ, flessibile conico 120 cm, supporto "Lux" in ottone cromato.

**332 RES**

Set "Relax SQ" composto da: doccia quadrata a pulsante art. 332 OS, flessibile conico 120 cm, rubinetto sottolavabo "SQ" con vitone ceramico e supporto "Lux" in ottone cromato.

**332 332 OS**

Set "Relax SQ" composto da: doccia quadrata a pulsante art. 332 OS, flessibile conico 120 cm, supporto "Lux" in ottone cromato.

**332 EURM**

Set "Eurolux" composto da: doccia a pulsante minimale in abs cromata art. 332EU, flessibile conico metallizzato 120 cm, rubinetto sottolavabo "Minimal" in ottone cromato e supporto cromato.

**332 332 EUM**

Set "Eurolux" composto da: doccia a pulsante minimale in abs cromata art. 332EU, flessibile conico metallizzato 120 cm, supporto cromato.

**332 REL 129**

Set "Relax" composto da: doccia a pulsante art. 332 OL, flessibile conico 120 cm, rubinetto sottolavabo nostro art. 129 e supporto "Lux" in ottone cromato.

**332 REZ 129**

Set "Relax" composto da: doccia a pulsante art. 332 OZ, flessibile conico 120 cms., rubinetto sottolavabo nostro art. 129 e supporto "Lux" in ottone cromato.

**332 REL**

Set "Relax", composto da: doccia a pulsante art. 332OL, flessibile conico 120 cm, rubinetto sottolavabo "Minimal" con vitone ceramico e supporto "Lux" in ottone cromato.

**332 332 OL**

Set "Relax", composto da: doccia a pulsante art. 332OL, flessibile conico 120 cm, supporto "Lux" in ottone cromato.

BOX INCASSO

KIT WELLNESS

CROMOTERAPIA

BRACCIE  
SOFFIONIPANNELLI  
DOCCIACOLONNE  
DOCCIA

SALISCENDI

DOCCETTE

SHUT-OFF

KIT BORDO  
VASCIA

BOCCHE

FLESSIBILI  
DOCCIA



**332 REW**

Set "Relax" composto da: doccia a pulsante art. 332OW, flessibile conico 120 cm, rubinetto sottolavabo "Minimal" con vitone ceramico e supporto "Lux" in ottone cromato.



**332 332 OW**

Set "Relax", composto da: doccia a pulsante art. 332OW, flessibile conico 120 cm, supporto "Lux" in ottone cromato.



**332 TEL**

Set composto da: doccia a pulsante, flessibile conico 120 cm, rubinetto temporizzato 1/2" in ottone cromato tempo di apertura 6-8 secondi.



**332 RG RR**

Set composto da flessibile retinato bianco cm 120, rompighetto con gancio, appendino, rubinetto sottolavabo.



**332 RER**

Set composto da: doccia a pulsante bianca art 332 OR, flessibile retinato 120 cm, rubinetto sottolavabo in ottone cromato e supporto bianco art 339 F BI.



**332 332 OR**

Set composto da: doccia a pulsante bianca art 332 OR, flessibile retinato 120 cm e supporto bianco art 339 F BI.



**332 RER CR**

Set composto da: doccia a pulsante cromata art 332 OR CR, flessibile conico 120 cm, rubinetto sottolavabo in ottone cromato e supporto cromato art 339 F.



**332 332 OR CR**

doccia a pulsante cromata art 332 OR CR, flessibile conico 120 cm e supporto cromato art 339 F.



**332 DP RR**

Set "Eco" composto da: doccia a pulsante bianca art 332 DP BN, flessibile retinato 120 cm, rubinetto sottolavabo in ottone cromato e gancio bianco art 332GA.



**332 12**

Set "Eco" composto da: doccia a pulsante bianca art 332 DP R, flessibile retinato 120 cm e gancio bianco art 332GA.



**332 DCR**

Set "Eco" composto da: doccia a pulsante cromata art 332 DP CR, flessibile cromato 120 cm, rubinetto sottolavabo in ottone cromato e gancio cromato art 332GA.



**332 332 DCR**

Set "Eco" composto da: doccia a pulsante cromata art 332 DP CR, flessibile cromato 120 cm e gancio cromato art 332GA.



DOCCE TTE SHUT-OFF IN OTTONE



Per richiedere il box, aggiungere...X al codice dell'articolo (es. 332 OLX).



**332 OS**

Doccetta a pulsante quadrata, serie "SQ", in ottone cromato, 1/2".

SENZA SCATOLA	CON SCATOLA
332 OS	332 OSX



**332 OL**

Doccetta a pulsante "Lux" in ottone cromato, con impugnatura liscia 1/2".

SENZA SCATOLA	CON SCATOLA
332 OL	332 OLX



**332 OZ**

Doccetta a pulsante "Lux" in ottone cromato, con impugnatura zigrinata 1/2".

SENZA SCATOLA	CON SCATOLA
332 OZ	332 OZX



NEW

**332 OB**

Doccetta a pulsante "Lux" in ottone cromato, con impugnatura bombata 1/2".

SENZA SCATOLA	CON SCATOLA
332 OB	332 OB X



**332 OLA**

Doccetta a pulsante "Lux" in ottone cromato, con impugnatura liscia da 1/2" completa di kit aeratore con chiave 83AC, nuovo sistema brevettato ad alta tecnologia per la pulizia dell'aeratore e di lunghissima durata.

SENZA SCATOLA	CON SCATOLA
332 OLA	332 OLA X



NEW

**332 OW**

Doccetta a pulsante "Lux" minimale in ottone cromato, con impugnatura liscia 1/2".

SENZA SCATOLA	CON SCATOLA
332 OW	332 OW X

DOCCE TTE SHUT-OFF IN ABS



**332 EU**

Doccetta a pulsante minimale in abs cromata con impugnatura liscia, 1/2".

SENZA SCATOLA	CON SCATOLA
332 EU	332 EU X



**332 DP CR**

Doccetta a pulsante, 1/2 cromata.



**332 DP BN**

Doccetta a pulsante, 1/2 bianca.



**332 LU CR**

Doccetta a pulsante, 1/2 cromata.



**332 OR**

Doccetta shut-off bianca in abs stampata made in italy.



NEW

**332 OR CR**

Doccetta shut-off cromata in abs stampata made in italy.



NEW

**332 OR NE**

Doccetta shut-off nera in abs stampata made in italy.

BOX INCASSO

KIT WELLNESS

CROMOTERAPIA

BRACCI E SOFFIONI

PANNELLI DOCCIA

COLONNE DOCCIA

SALISCENDI

DOCCE TTE

SHUT-OFF

KIT BORDO VASCA

BOCCH E

FLESSIBILI DOCCIA

## WELLNESS: SHUT-OFF



### 332 RG RE 120

Set composto da flessibile retinato bianco cm 120, rompigitto con gancio, appendino.



### 332 RG

Rompigitto in abs cromato con anello per attacco a muro.



### 81 RD 12

Riduzione 1/2MxM22 di collegamento flessibile doccia con aeratore F22 (nostro art. 81).



### 332 GA

Appendino in abs cromato.



### 332 GA BI

Appendino in abs bianco.



### 81

Aeratore classico con retine in inox, per gruppo livello F22.



Doccia duplex esterna con supporto in ottone e con flessibile cm 150, doccetta ottone normale o pesante.

OTTONE NORMALE	OTTONE PESANTE
<b>320 N</b>	<b>320 P</b>



Doccetta per duplex in ottone con curveta, normale o pesante.

OTTONE NORMALE	OTTONE PESANTE
<b>328 N</b>	<b>328 P</b>



Doccetta in ottone con tubo interno in ottone, normale o pesante.

OTTONE NORMALE	OTTONE PESANTE
<b>326 N</b>	<b>326 P</b>



### 320 LI

Doccia duplex esterna "Liberty" con supporto in ottone e con flessibile cm 150.

## LINEA PARRUCCHIERE



### K66 DO NE

Doccetta per parrucchiere, nera.

SENZA SCATOLA	CON SCATOLA
<b>K 66 DO NE</b>	<b>K 66 DO NEX</b>



### K66 SU

Supporto per doccetta parrucchiere.



### K66 FL

Flessibile in plastica grigio metallizzato, M15x1 girevole, 3/8F, cm 120.



### K66 FL NY

Flessibile in nylon nero, M15x1 girevole, 3/8F, cm 120.



### K66 CO

Miscelatore per parrucchiere.

## ACCESSORI DOGGIA



**335 P**  
Supporto snodato in Abs cromato, per flessibile con attacco conico e zigrinato.



**338**  
Supporto snodato in ottone cromato "Liberty" per duplex esterno, con attacco conico.



**337 M**  
Preso acqua e supporto lusso minimale in ottone cromato per incasso, per flessibile con attacco conico.



**337 Q**  
Preso acqua e supporto lusso quadrato, in ottone cromato per incasso, per flessibile con attacco conico.



**337 S**  
Preso acqua e supporto lusso quadrato in ottone cromato per incasso, per flessibile con attacco conico.



**339 SOM**  
Supporto "minimale" in ottone cromato per flessibile con attacco conico.



**339**  
Supporto snodato in Abs cromato, per flessibile con attacco conico.



**339 L**  
Supporto "minimale" snodato a braccio in Abs cromato, per flessibile con attacco conico.



**339 F**  
Supporto fisso in Abs cromato, per flessibile con attacco conico.



**339 F BI**  
Supporto fisso in Abs bianco, per flessibile con attacco conico.



**339 SO**  
Supporto "Lux" in ottone cromato, per flessibile con attacco conico.



**339 SOS**  
Supporto fisso quadrato in ottone cromato per flessibile con attacco conico.



**339 R3**  
Supporto fisso a 3 posizioni in Abs cromato per flessibile con attacco conico.



**339 N**  
Supporto snodato a braccio serie "Minimal", in Abs cromato, per flessibile con attacco conico.



**339 S**  
Supporto snodato a braccio serie "SQ", in Abs cromato, per flessibile con attacco conico.



**339 SS**  
Supporto snodato a braccio serie "SQ", in ottone cromato, per flessibile con attacco conico.



**336 L**  
Rubinetto d'arresto serie "Minimal", con supporto doccia in ottone cromato, per flessibile con attacco conico.



**336 S**  
Rubinetto d'arresto serie "SQ", con supporto doccia in ottone cromato, per flessibile con attacco conico.



**336**  
Supporto snodato in ottone cromato per duplex esterno per art. 328.



**325**  
Curva in ottone cromato per doccia, 1/2.



**325 07**  
Supporto per doccia estraibile per bordo lavello e bordo vasca, modello a base tonda.



**325 S 07**  
Supporto dritto per doccia estraibile per bordo lavello e bordo vasca, modello a base quadra.

BOX INCASSO

KIT WELLNESS  
CROMOTERAPIA

BRACCI E SOFFIONI

PANNELLI DOGGIA

COLONNE DOGGIA

SALISCENDI

DOCCETTE

SHUT-OFF

KIT BORDO VASCA

BOCCHIE

FLESSIBILI DOGGIA

# KIT BORDO VASCA



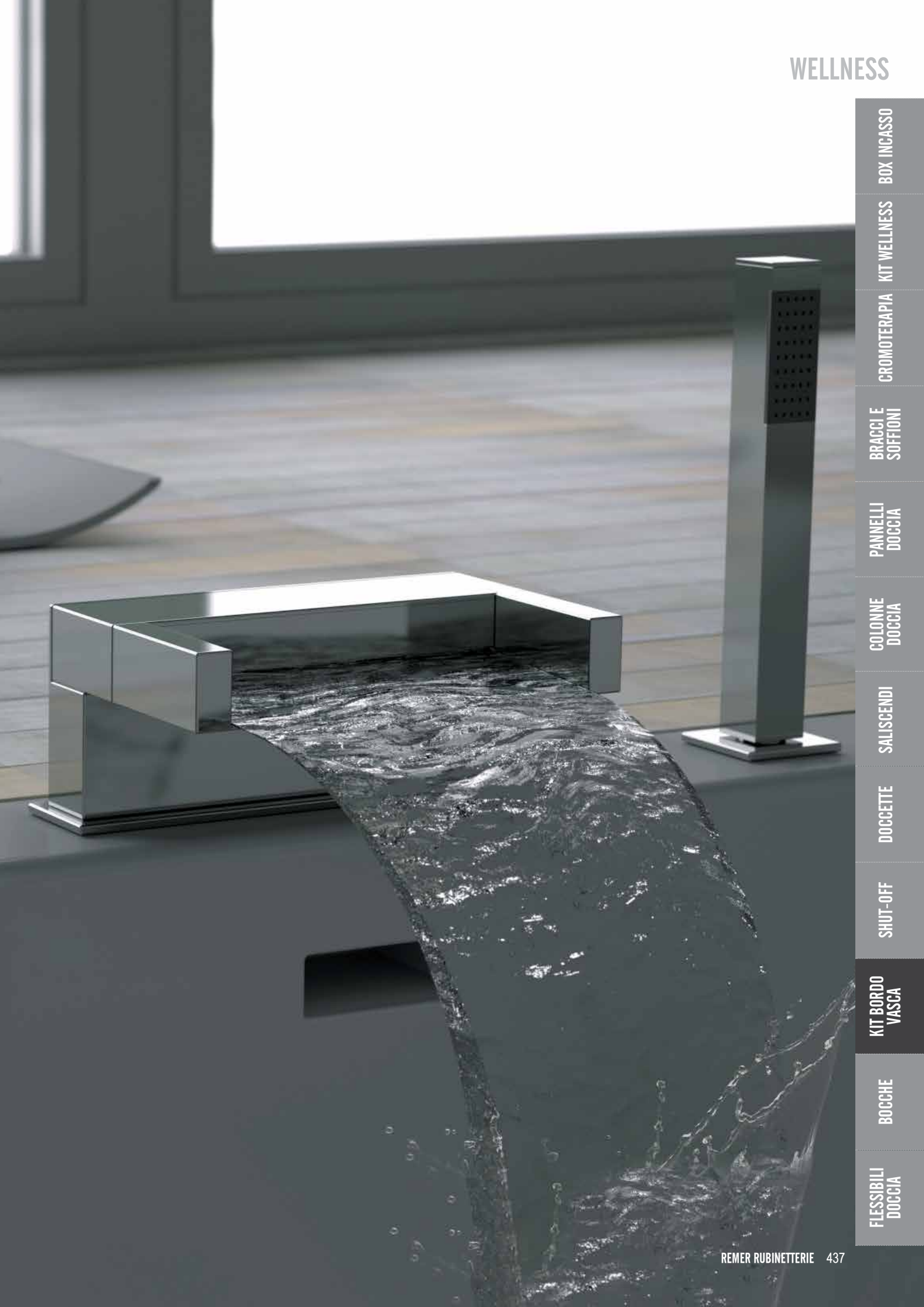

BOX INCASSO

KIT WELLNESS

CROMOTERAPIA

BRACCI E SOFFIONI

PANNELLI DOCCIA

COLONNE DOCCIA

SALISCENDI

DOCCETTE

SHUT-OFF

KIT BORDO VASCA

BOCCHE

FLESSIBILI DOCCIA



## WELLNESS: KIT BORDO VASCA

### SIMBOLOGIE:



Con Kit Doccia e flessibile  
lungo: 120, 150 o 200 cm



Doccetta Anti-  
calcare



Getto  
Esterno



Getto aerato  
intenso



Getto spray delicato ad ampia  
copertura con getto vigoroso  
all'esterno a risparmio idrico



Getto con massaggio  
intenso a risparmio idrico



Getto ad ampia  
copertura effetto pioggia



Con getto a  
cascata



Con  
multigetto



Con tecnologia ambient  
led faucet



Doccetta  
estraibile

## COLOR & AMBIENT



### QR 07

Miscelatore monocomando bordo vasca con deviatore integrato sulla bocca e doccetta in ottone cromato.



### NR 07 2

Miscelatore monocomando bordo vasca con cartuccia con luce a led, deviatore integrato sulla bocca e doccetta minimale in ottone cromato.

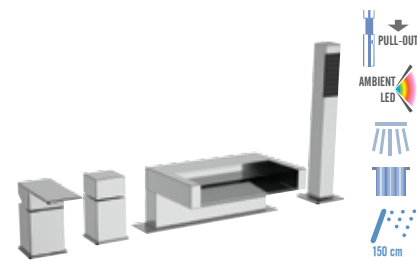

### QA 06

Miscelatore monocomando bordo vasca con deviatore, doccetta in ottone cromato e bocca a cascata con dispositivo luminoso AMBIENT.

## DESIGN & EASY CONTEMPORARY



### I 07

Miscelatore monocomando bordo vasca con deviatore integrato nella bocca e doccetta anti-calcare.



### I 07 UF

Miscelatore monocomando bordo vasca con deviatore integrato nel miscelatore, bocca a cascata e doccetta anti-calcare.



### I 06

Miscelatore monocomando bordo vasca con deviatore, bocca con effetto multigetto e doccetta cromata.



### L 06

Miscelatore monocomando bordo vasca con deviatore, bocca con effetto multigetto e doccetta cromata a 4 funzioni.



### L 07

Miscelatore monocomando bordo vasca con deviatore integrato nella bocca, bocca minimale in ottone cromato e doccetta cromata a 4 funzioni.



### L 07 UF

Miscelatore monocomando bordo vasca con deviatore integrato nel miscelatore, bocca a cascata e doccetta cromata a 4 funzioni.



**W 07**

Miscelatore monocomando bordo vasca con deviatore integrato nella bocca minimale e doccetta in ABS cromato a 4 funzioni.



**W 07 UF**

Miscelatore monocomando bordo vasca con deviatore integrato nel miscelatore, bocca a cascata e doccetta in ABS cromato a 4 funzioni.



**D 07**

Miscelatore monocomando bordo vasca con deviatore integrato nella bocca minimale e doccetta in ABS cromato a 4 funzioni.



**D 06**

Miscelatore monocomando bordo vasca con deviatore, bocca con effetto multigetto e doccetta in ABS a 4 funzioni.



**D 07 UF**

Miscelatore monocomando bordo vasca con deviatore integrato nel miscelatore, bocca a cascata e doccetta in ABS cromato a 4 funzioni.



**DC 06**

Miscelatore monocomando bordo vasca con deviatore, bocca con effetto cascata e doccetta in ABS a 4 funzioni.



**N 07**

Miscelatore monocomando bordo vasca con deviatore integrato nella bocca minimale e doccetta.



**N 06**

Miscelatore monocomando bordo vasca con deviatore, bocca con effetto multigetto e doccetta in ABS a 4 funzioni.



**N 06 317 MM**

Miscelatore monocomando bordo vasca con deviatore, bocca con effetto multigetto e doccetta in ottone cromato.



**J 07**

Miscelatore monocomando bordo vasca con deviatore integrato nella bocca minimale e doccetta minimale in ottone cromato.



**J 06**

Miscelatore monocomando bordo vasca con deviatore, bocca con effetto multigetto e doccetta in ottone cromato.

BOX INCASSO

KIT WELLNESS

CROMOTERAPIA

BRACCI E SOFFIONI

PANNELLI DOCCIA

COLONNE DOCCIA

SALISCENDI

DOCCETTE

SHUT-OFF

KIT BORDO VASCA

BOCCE

FLESSIBILI DOCCIA



**Z 07**

Miscelatore monocomando bordo vasca serie Flash con bocca quadra, deviatore integrato nella bocca e doccetta quadrata estraibile ad 1 funzione in ottone cromato.

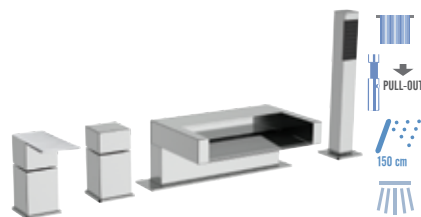

**ZC 06**

Miscelatore monocomando bordo vasca con deviatore, doccetta ad 1 funzione in ottone cromato e bocca a cascata.

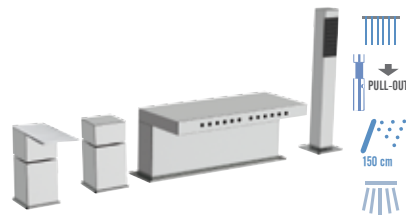

**Z 06**

Miscelatore monocomando bordo vasca con deviatore, doccetta ad 1 funzione in ottone cromato e bocca multigetto.



**Q 07**

Miscelatore monocomando bordo vasca serie Qubika con bocca quadra, deviatore integrato nella bocca, doccetta quadrata estraibile ad 1 funzione in ottone cromato.

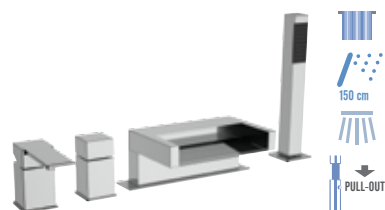

**QC 06**

Miscelatore monocomando bordo vasca con deviatore, bocca cascata e doccetta estraibile ad 1 funzione in ottone cromato



**Q 06**

Miscelatore monocomando bordo vasca con deviatore, bocca con effetto multigetto e doccetta estraibile ad 1 funzione in ottone cromato.



**S 07 3**

Miscelatore monocomando bordo vasca con bocca quadra, deviatore integrato nella bocca e doccetta quadrata estraibile ad 1 funzione in ottone cromato.



**S 06 3**

Miscelatore monocomando bordo vasca con deviatore, bocca con effetto multigetto e doccetta estraibile ad 1 funzione in ottone cromato.

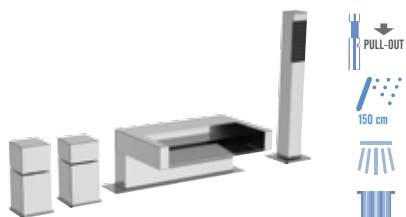

**SC 06 3**

Miscelatore monocomando bordo vasca con deviatore, bocca cascata e doccetta estraibile ad 1 funzione in ottone cromato.

## CONTRACT



### P 07

Miscelatore monocomando bordo vasca con deviatore integrato nella bocca, bocca pesante fusa e doccetta estraibile con idromassaggio e anti-calcare a 4 funzioni.



### P 07 UF

Miscelatore monocomando bordo vasca con deviatore integrato nel miscelatore, bocca pesante fusa con effetto a cascata e doccetta estraibile con idromassaggio e anti-calcare a 4 funzioni.



### T 07

Miscelatore monocomando bordo vasca con deviatore integrato nella bocca, bocca pesante fusa e doccetta estraibile con idromassaggio e anti-calcare a 4 funzioni.



### T 07 UF

Miscelatore monocomando bordo vasca con deviatore integrato nel miscelatore, bocca pesante fusa con effetto a cascata e doccetta estraibile con idromassaggio e anti-calcare a 4 funzioni.



### G 07 4

Miscelatore monocomando bordo vasca serie con deviatore integrato nella bocca, bocca pesante fusa e doccetta estraibile con idromassaggio e anti-calcare a 4 funzioni.



### G 07 4 UF

Miscelatore monocomando bordo vasca con deviatore integrato nel miscelatore, bocca pesante fusa con effetto a cascata e doccetta estraibile con idromassaggio e anti-calcare a 4 funzioni.



### M 07

Miscelatore monocomando bordo vasca con deviatore integrato nella bocca, bocca pesante fusa e doccetta estraibile con idromassaggio e anti-calcare a 4 funzioni.



### M 07 UF

Miscelatore monocomando bordo vasca con deviatore integrato nel miscelatore, bocca pesante fusa con effetto a cascata e doccetta estraibile con idromassaggio e anti-calcare a 4 funzioni.



### R 07

Miscelatore monocomando bordo vasca serie Remix con deviatore integrato nella bocca, bocca pesante fusa e doccetta estraibile ad 1 funzione.



### K 07

Miscelatore monocomando bordo vasca serie Kiss con deviatore integrato nella bocca, bocca pesante fusa e doccetta estraibile con idromassaggio e anti-calcare a 4 funzioni.



### K 07 UF

Miscelatore monocomando bordo vasca con deviatore integrato nel miscelatore, bocca pesante fusa con effetto a cascata e doccetta estraibile con idromassaggio e anti-calcare a 4 funzioni.



### F 07 2

Miscelatore monocomando bordo vasca serie 35 con deviatore integrato nella bocca, bocca pesante fusa e doccetta estraibile ad 1 funzione.

BOX INCASSO

KIT WELLNESS  
CROMOTERAPIA

BRACCI E SOFFIONI

PANNELLI DOCCIA

COLONNE DOCCIA

SALISCENDI

DOCCETTE

SHUT-OFF

KIT BORDO VASCA

BOCCHIE

FLESSIBILI DOCCIA

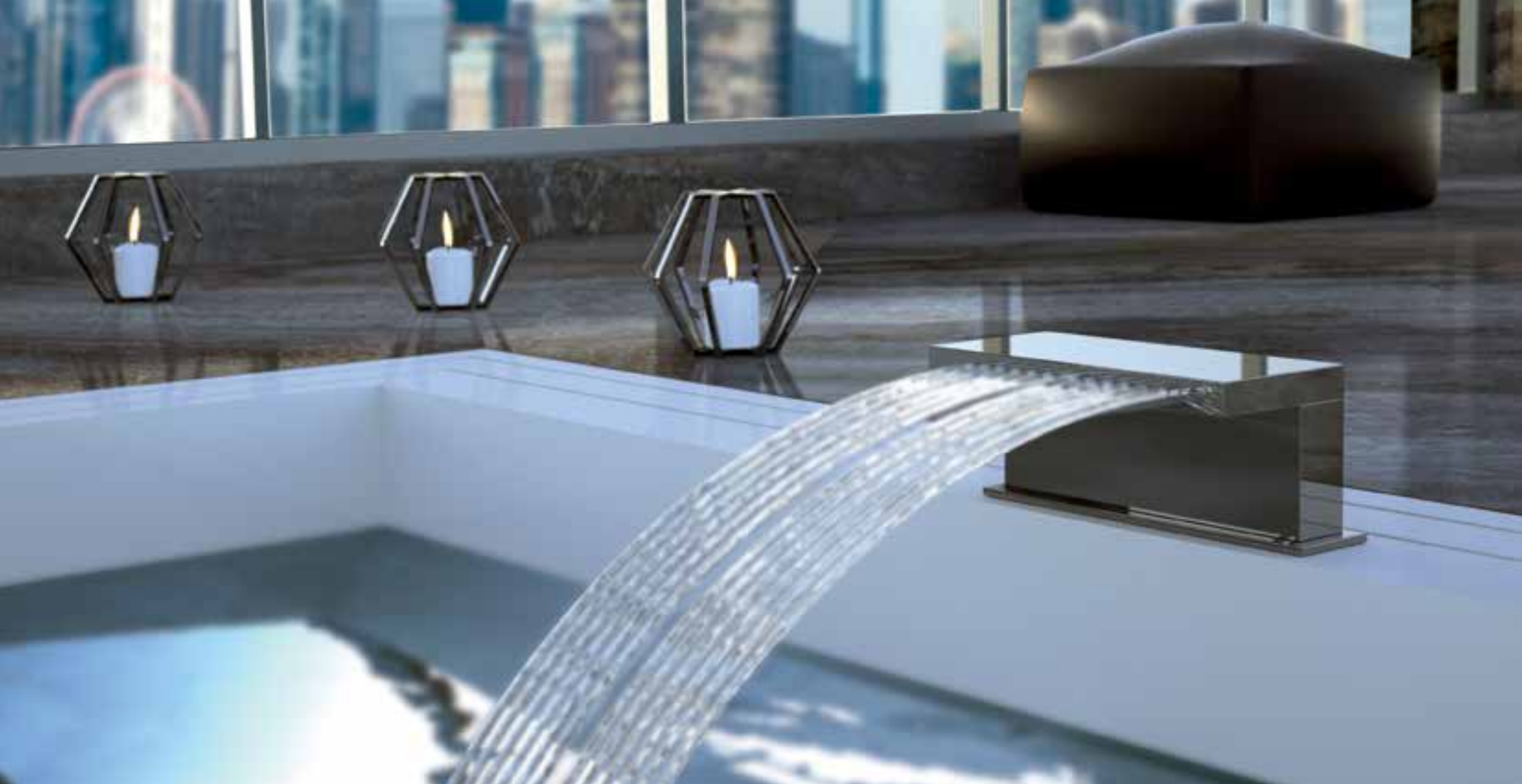

# BOCCHIE

## SIMBOLOGIE:

 Con getto a cascata

 Con multigetto

 Con tecnologia ambient led faucet

 Con Luce Led

## BOCCHIE A CASCATA

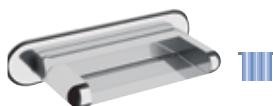

### 91 NC

Bocca incasso cascata con bordi arrotondati, serie Minimal.



### 91 NCF

Bocca bordo vasca con effetto multigetto ed angoli arrotondati, serie Minimal.



### 91 UF07

Bocca bordo vasca con getto a cascata.



### 91 QC

Bocca incasso cascata serie Qubika, cm 18.

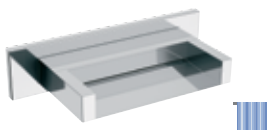

### 91 ZC

Bocca incasso cascata, serie Flash.

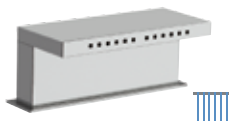

### 91 ZCF

Bocca bordo vasca con effetto multigetto serie Flash.

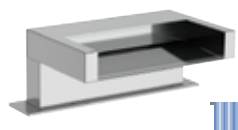

### 91 ZCA

Bocca bordo vasca getto a cascata, serie Flash.

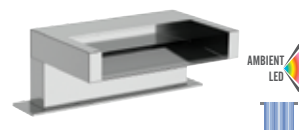

### 91 QA

Bocca a cascata bordo vasca con dispositivo luminoso AMBIENT.



### 359 XS

Boccal/soffione a cascata ad incasso squadrato in acciaio INOX lucidato a specchio.



### 359 XM

Boccal/soffione a cascata ad incasso con angoli arrotondati in acciaio INOX lucidato a specchio.



### 359 XL

Boccal/soffione a cascata ad L in acciaio INOX lucidato a specchio.



## BOCCHIE A SOFFITTO

## WELLNESS

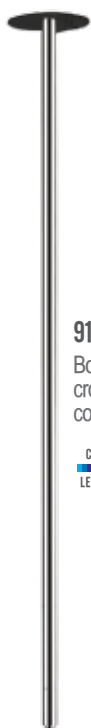

### 91 V NR

Bocca da soffitto in ottone cromato lunghezza 166 cm, con dispositivo color.



### 91 VL NR

Bocca da soffitto in ottone cromato lunghezza 181 cm, con dispositivo color.

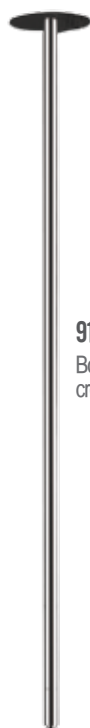

### 91 V N2

Bocca da soffitto in ottone cromato lunghezza 166 cm.



### 91 VL N2

Bocca da soffitto in ottone cromato lunghezza 181 cm.

BOX INCASSO

KIT WELLNESS

CROMOTERAPIA

BRACCI E SOFFIONI

PANNELLI DOCCIA

## BOCCHIE INCASSO



### 91 NR

Bocca incasso cm 18, serie Minimal Color.



### 91 N2

Bocca incasso cm 18, serie Minimal.



### 91 M

Bocca incasso cm 18, serie Minimal.



### 91 MD

Bocca incasso serie Minimal, cm 18, con deviatore integrato.



### 91 QR

Bocca incasso con luce led serie Q Color.



### 91 Q2

Bocca incasso serie Q.



### 91 Q

Bocca incasso serie Qubika, cm 18.



### 91 QD

Bocca incasso serie Qubika, cm 18, con deviatore integrato.

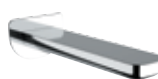

### 91 I

Bocca incasso cm 18, serie Infinity.



### 91 DR

Bocca incasso serie Dream, cm 18.



### 91 V

Bocca incasso, serie Vanity, 16,5 cm.



### 91 X

Bocca incasso, serie X Style, 16,5 cm.

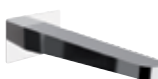

### 91 L

Bocca incasso cm 18, serie Class Line.



### 91 LD

Bocca incasso cm 18 con deviatore.

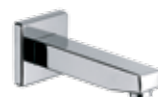

### 91 S

Bocca incasso quadrata cm 18, serie Square.



### 91 SD

Bocca incasso quadrata cm 18, serie Square con deviatore.



### 91

Bocca incasso vasca-doccia.



### 91 D

Bocca incasso vasca-doccia, con deviatore integrato.

COLONNE DOCCIA

SALISCENDI

DOCCETTE

SHUT-OFF

KIT BORDO VASCA

BOCCHIE

FLESSIBILI DOCCIA



# FLESSIBILI DOCCIA



BOX INCASSO

KIT WELLNESS

CROMOTERAPIA

BRACCI E SOFFIONI

PANNELLI DOCCIA

COLONNE DOCCIA

SALISCENDI

DOCCETTE

SHUT-OFF

KIT BORDO VASCA

BOCCHE

**FLESSIBILI DOCCIA**



FLESSIBILI PER DOCCIA



**332 CN BC**

Flessibile doccia in PVC atossico con piattina cromata, attacco conico.

cm 120	cm 150	cm 200
--------	--------	--------



**332 CN MTR**

Flessibile per doccia retinato metallizzato in PVC atossico, con attacco conico.

cm 120	cm 150	cm 200
--------	--------	--------



Girevole antitorsione

**332 CN MTRA**

Flessibile per doccia retinato metallizzato in PVC atossico, con sistema girevole ed anti-torsione, e attacco conico.

cm 120	cm 150	cm 200
--------	--------	--------



**332 CN 2G**

Flessibile per doccia retinato metallizzato in pvc atossico, con attacco doppio brillante conico.

cm 120	cm 150	cm 200
--------	--------	--------



**332 CN DR**

Flessibile doccia in pvc trasparente con piattina trecciata e dorata, interno in gomma epdm alimentare, con un attacco conico.

cm 120	cm 150	cm 200
--------	--------	--------



**332 CN DO**

Flessibile doccia retinato dorato in pvc atossico, interno in gomma epdm alimentare, con un attacco conico.

cm 120	cm 150	cm 200
--------	--------	--------



**332 CN MT**

Flessibile per doccia in pvc atossico grigio metallizzato, con attacco conico.

cm 120	cm 150	cm 200
--------	--------	--------



**332 CN**

Flessibile "Biflex" per doccia in pvc atossico, con attacco conico, in cromo bianco.

cm 120	cm 150	cm 200
--------	--------	--------



**332**

Flessibile "Biflex" per doccia in pvc atossico, con attacco a doppia ghiera.

cm 120	cm 150	cm 200
--------	--------	--------



**332 CN NC**

Flessibile "Biflex" per doccia in pvc atossico, con attacco conico, in cromo nero.

cm 120	cm 150	cm 200
--------	--------	--------



**332 CN NG**

Flessibile per doccia in nylon grigio, con attacco conico.

cm 120	cm 150	cm 200
--------	--------	--------



**332 CN NY**

Flessibile per doccia in nylon nero, con attacco conico.

cm 120	cm 150	cm 200
--------	--------	--------



### 332 CN NB

Flessibile per doccia in nylon bianco, con attacco conico.

cm 120

cm 150

cm 200



### 332 CN RE BI

Flessibile per doccia retinato in pvc atossico, con un attacco conico, retinatura bianca.

cm 120

cm 150

cm 200



### 332 RE BI

Flessibile per doccia retinato in pvc atossico, con attacco a doppia ghiera retinatura bianca.

cm 120

cm 150

cm 200

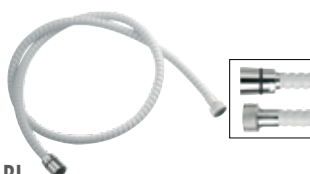

### 334 CN BI

Flessibile doccia Spyroflex, bianco, in pvc atossico, con un attacco conico.

cm 120

cm 150

cm 200

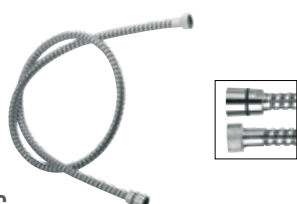

### 334 CN NC

Flessibile per doccia Spyroflex nero-cromo in pvc atossico, con un attacco conico.

cm 120

cm 150

cm 200

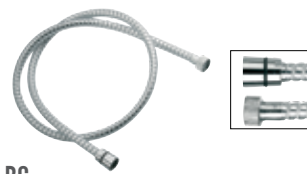

### 334 CN BC

Flessibile doccia Spyroflex, bianco-cromo, in pvc atossico, con un attacco conico.

cm 120

cm 150

cm 200



### 334 CN NE

Flessibile per doccia Spyroflex nero in pvc atossico, con un attacco conico.

cm 120

cm 150

cm 200

BOX INCASSO

KIT WELLNESS

CROMOTERAPIA

BRACCI E SOFFIONI

PANNELLI DOCCIA

COLONNE DOCCIA

SALISCENDI

DOCCETTE

SHUT-OFF

KIT BORDO VASCA

BOCCHE

FLESSIBILI DOCCIA



FLESSIBILI PER DOCCIA ESTRAIBILE

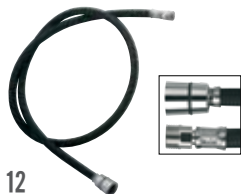

**332 NY 15 12**

Flessibile doccia per estraibile cucina, con interno in gomma epdm alimentare, tracciato in nylon nero, con attacco conico + maschio girevole 15x1.

cm 120	cm 150	cm 200
--------	--------	--------



**332 NG 15 12**

Flessibile doccia per estraibile cucina, con interno in gomma epdm alimentare, tracciato in nylon grigio, con attacco conico + maschio girevole 15x1.

cm 120	cm 150	cm 200
--------	--------	--------

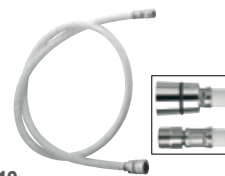

**332 NB 15 12**

Flessibile doccia per estraibile cucina, con interno in gomma epdm alimentare, tracciato in nylon bianco, con attacco conico + maschio girevole 15x1.

cm 120	cm 150	cm 200
--------	--------	--------

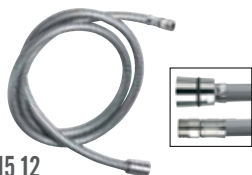

**332 MT 15 12**

Flessibile doccia per estraibile cucina, in pvc atossico metallizzato, con attacco conico + maschio girevole 15x1.

cm 120	cm 150	cm 200
--------	--------	--------

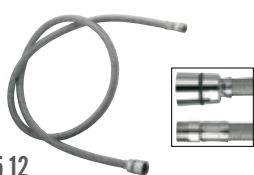

**332 IN 15 12**

Flessibile doccia per estraibile cucina, tracciato in acciaio inox, con interno in gomma epdm alimentare, con attacco conico + maschio girevole 15x1.

cm 120	cm 150	cm 200
--------	--------	--------



**332 NX 15 12**

Flessibile doccia per estraibile cucina, con interno in gomma epdm alimentare, tracciato in nylon nero e acciaio inox, con attacco conico + maschio girevole 15x1.

cm 120	cm 150	cm 200
--------	--------	--------



**332 FN 15 12**

Flessibile doccia per estraibile cucina, con interno in gomma epdm alimentare, tracciato in nylon nero con fantasia in acciaio inox, con attacco conico + maschio girevole 15x1.

cm 120	cm 150	cm 200
--------	--------	--------



**332 BX 15 12**

Flessibile doccia per estraibile cucina, con interno in gomma epdm alimentare, tracciato in nylon bianco e acciaio inox, con attacco conico + maschio girevole 15x1.

cm 120	cm 150	cm 200
--------	--------	--------



**332 FB 15 12**

Flessibile doccia per estraibile cucina, con interno in gomma epdm alimentare, tracciato in nylon bianco con fantasia in acciaio inox, con attacco conico + maschio girevole 15x1.

cm 120	cm 150	cm 200
--------	--------	--------

FLESSIBILI IN OTTONE CROMATO



**333**  
Flessibile per doccia in ottone cromato con attacco a doppia ghiera, tubo in EPDM.

cm 100   cm 120   cm 150   cm 200



**333 CN**  
Flessibile per doccia in ottone cromato Ø 14 F.F., con attacco conico, tubo in EPDM.

cm 120   cm 150   cm 200

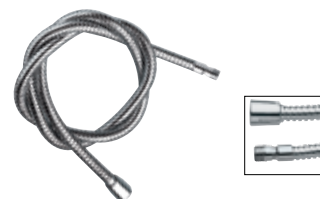

**333 CN 15 12**  
Flessibile per doccia estraibile in ottone cromato Ø 14, M15x1, 1/2" con attacco conico, tubo in EPDM.

cm 120   cm 150



**333 CNX**  
Flessibile per doccia estraibile in acciaio INOX Ø 14, tubo interno in gomma EPDM, attacco conico, 1/2".

cm 120   cm 150   cm 200



**333 MO**  
Flessibile per monoforo in ottone cromato Ø 14, 3/8x15x1M.

cm 120   cm 150



**333 CN ES**  
Flessibile per doccia estensibile a doppia graffatura in ottone cromato Ø 14 F.F., tubo in EPDM.

cm 120   cm 150   cm 200



**333 CN UK**  
Flessibile per doccia a doppia graffatura in ottone cromato Ø 17 F.F., tubo in EPDM, con attacco conico.

cm 150   cm 200



Girevole antitorsione

**333 CN DG AT**  
Flessibile per doccia estensibile a doppia graffatura in ottone, con sistema girevole ed anti-torsione, Ø 15 mm, tubo in EPDM, con attacco conico.

cm 120   cm 150   cm 200

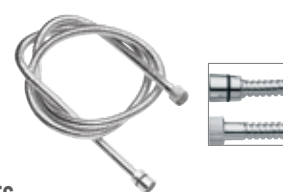

**333 CNX ES**  
Flessibile per doccia estensibile a doppia graffatura in acciaio INOX Ø 14 F.F., tubo in EPDM, con attacco conico.

cm 100   cm 120   cm 150   cm 175

BOX INCASSO

KIT WELLNESS

CROMOTERAPIA

BRACCI E SOFFIONI

PANNELLI DOCCIA

COLONNE DOCCIA

SALISCENDI

DOCCETTE

SHUT-OFF

KIT BORDO VASCA

BOCCHE

FLESSIBILI DOCCIA

A modern bathroom sink with a chrome faucet, a soap dish, and a soap tray, set against a backdrop of a city skyline. The sink is white and oval-shaped, with a chrome faucet that has a long, horizontal spout and a vertical handle. A chrome soap dish is mounted on the wall, holding a bar of yellow soap. A white soap tray is on the sink's edge. The background shows a city skyline with many skyscrapers under a clear sky.

# ACCESSORI BAGNO



LOUNGE

FLAT

DELICATA

MINIMAL  
INOX

'900

SQ

FORMA

ARTE

SUITE

EPOCA

ACCESSORI

IDROSCOPINI

# LOUNGE



**LN 13**  
Dispenser per sapone liquido in ceramica con supporto in ottone cromato.



**LN 15**  
Portabicchiere in ottone cromato con bicchiere in ceramica.



**LN 10**  
Portasapone in ceramica con supporto in ottone cromato.



**LN 50**  
Appendino in ottone cromato.



**LN 44**  
Portasalviette in ottone cromato, 23,6x70 mm.



**LN 60**  
Portarotolo in ottone cromato.



**LN 61**  
Portarotolo di ricambio in ottone cromato.



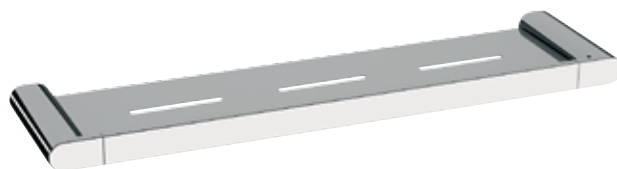

**LN 20**  
Mensola in ottone cromato,  
dimensione 13x51 cm.



**LN 40**  
Portasalviette in ottone cromato,  
lunghezza cm 40.



**LN 30**  
Portasalviette in ottone cromato,  
lunghezza cm 60.



**LN 33**  
Portasalviette doppio in ottone  
cromato, lunghezza cm 60.

LOUNGE

FLAT

DELICATA

MINIMAL  
INOX

'900

SQ

FORMA

ARTE

SUITE

EPOCA

ACCESSORI

IDROSCOPINI

## RICAMBI



**ACGL 10 LN**  
Portasapone.



**ACGL 13 LN**  
Dispenser.



**ACGL 15 LN**  
Bicchiere.

# FLAT



**FT 13**  
Dispenser per sapone liquido in ceramica con supporto in ottone cromato.



**FT 15**  
Portabicchiere in ottone cromato con bicchiere in ceramica.



**FT 10**  
Portasapone in ceramica con supporto in ottone cromato.



**FT 50**  
Appendino in ottone cromato.



**FT 44**  
Portasalviette ad anello in ottone cromato.



**FT 36**  
Portasciugamano a braccia girevoli in ottone cromato, lunghezza cm 45.



**FT 66**  
Portascopino in ceramica con supporto in ottone cromato.



**FT 60**  
Portarotolo in ottone cromato.



**FT 61**  
Portarotolo di ricambio in ottone cromato.

# ACCESSORI BAGNO



**FT 20**  
Mensola in vetro con supporti in ottone cromato, dimensione 12x52 cm.



**FT 40**  
Portasalviette in ottone cromato, lunghezza cm 40.



**FT 30**  
Portasalviette in ottone cromato, lunghezza cm 60.



**FT 33**  
Portasalviette doppio in ottone cromato, lunghezza cm 60.



**FT SET 8P**  
Set serie FLAT composto da 8 accessori:  
- 2 portasapone  
- 1 portabicchiere  
- 1 portasalviette cm 60  
- 1 portasalviette cm 40  
- 1 portasalviette ad anello  
- 1 appendino  
- 1 portarotolo

LOUNGE

FLAT

DELICATA

MINIMAL  
INOX

'900

SQ

FORMA

ARTE

SUITE

EPOCA

ACCESSORI

IDROSCOPINI

## RICAMBI



**AC 66 FT**  
Scopino da bagno.



**ACCE 10 FT**  
Portasapone in ceramica.



**ACCE 13 FT**  
Dispenser in ceramica.



**ACCE 15 MI**  
Bicchiere in ceramica.

# DELICATA



## DE 13

Dispenser per sapone liquido in ceramica con supporto in ottone cromato.



## DE 15

Portabicchiere in ottone cromato con bicchiere in ceramica.



## DE 10

Portasapone in ceramica con supporto in ottone cromato.



## DE 50

Appendino in ottone cromato.



## DE 44

Portasalviette ad anello in ottone cromato.



## DE 60

Portarotolo in ottone cromato.



## DE 61

Portarotolo di ricambio in ottone cromato.



## DE 66

Portascopino in ceramica con supporto in ottone cromato.



**DE 20**  
Mensola in vetro con supporti in ottone cromato, dimensione 11,5x51,5 cm.



**DE 40**  
Portasalviette in ottone cromato, lunghezza cm 40.



**DE 30**  
Portasalviette in ottone cromato, lunghezza cm 60.



**DE SET 8P**  
Set serie DELICATA composto da 8 accessori:  
- 2 portasapone  
- 1 portabicchiere  
- 1 portasalviette cm 60  
- 1 portasalviette cm 40  
- 1 portasalviette ad anello  
- 1 appendino  
- 1 portarotolo

LOUNGE

FLAT

DELICATA

MINIMAL  
INOX

'900

SQ

FORMA

ARTE

## RICAMBI



**AC 66 DE**  
Scopino da bagno.



**ACCE 10 DE**  
Portasapone in ceramica.



**ACCE 13 DE**  
Dispenser in ceramica.



**ACCE 15 DE**  
Bicchiere in ceramica.

SUITE

EPOCA

ACCESSORI

IDROSCOPINI



# MINIMAL INOX



**MI 18 INOX**

Supporto doppio in acciaio INOX completo di bicchiere e dispenser in ceramica.



**MI 13 INOX**

Dispenser per sapone liquido in ceramica con supporto in acciaio INOX.



**MI 17 INOX**

Supporto doppio in acciaio INOX completo di bicchiere e portasapone in ceramica.



**MI 16 INOX**

Portabicchiere doppio in acciaio INOX con bicchieri in ceramica.



**MI 15 INOX**

Portabicchiere in acciaio INOX con bicchiere in ceramica.



**MI 10 INOX**

Portasapone in ceramica con supporto in acciaio INOX.



**MI 50 INOX**

Appendino in acciaio INOX.



**MI 44 INOX**

Portasalviette ad anello in acciaio INOX.



**MI 60 INOX**

Portarotolo in acciaio INOX.



**MI 62 INOX**

Portarotolo di ricambio in acciaio INOX.



**MI 66 INOX**

Portascopino in ceramica con supporto in acciaio INOX.

# ACCESSORI BAGNO



## MI 40 INOX

Portasalviette in acciaio INOX, lunghezza cm 40.



## MI 30 INOX

Portasalviette in acciaio INOX, lunghezza cm 60.



## MI 33 INOX

Portasalviette doppio in acciaio INOX, lunghezza cm 60.



## MI 70 INOX

Portasciugamano multiplo in acciaio INOX, lunghezza cm 60.



## MI 20 INOX

Mensola in vetro con supporti in acciaio INOX, dimensione 12x53 cm.

LOUNGE

FLAT

DELICATA

MINIMAL  
INOX

'900

SQ

FORMA

ARTE

SUITE

EPOCA

ACCESSORI

IDROSCOPINI

## RICAMBI



## AC 66 SQ

Scopino da bagno.



## ACCE 10 MI

Portasapone in ceramica.



## ACCE 13 MI

Dispenser in ceramica.



## ACCE 15 MI

Bicchiere in ceramica.

# 900



FINITURE:

CR Cromo

VR Vecchio rame

NP Nichel spazzolato

VO Vecchio ottone



**NV 13**

Dispenser per sapone liquido in vetro con supporto in ottone cromato.



**NV 15**

Portabicchiere in ottone cromato con bicchiere in vetro.



**NV 10**

Portasapone in vetro con supporto in ottone cromato.



**NV 11**

Portasapone in ottone cromato.



**NV 50**

Appendino in ottone cromato.



**NV 44**

Portasalviette ad anello in ottone cromato.



**NV 60**

Portarotolo in ottone cromato.



**NV 62**

Portarotolo di ricambio in ottone cromato.



**NV 66**

Portascopino in ceramica con supporto in ottone cromato.

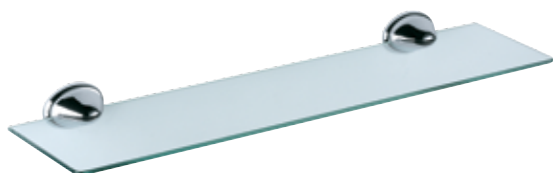

**NV 20**  
Mensola in vetro con supporti in ottone cromato, dimensione 10x50 cm.



**NV 40**  
Portasalviette in ottone cromato, lunghezza cm 40.



**NV 30**  
Portasalviette in ottone cromato, lunghezza cm 60.

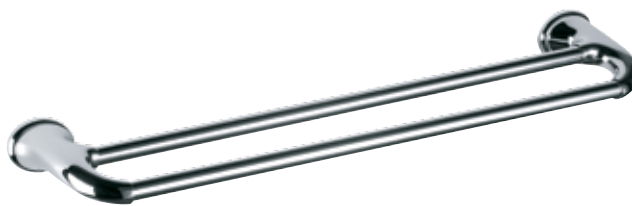

**NV 33**  
Portasalviette doppio in ottone cromato, lunghezza cm 60.



**NV 70**  
Portasalviette multiplo in ottone cromato, lunghezza cm 60.



**NV SET 8P**  
Set serie '900 composto da 8 accessori:  
- 2 portasapone  
- 1 portabicchiere  
- 1 portasalviette cm 60  
- 1 portasalviette cm 40  
- 1 portasalviette ad anello  
- 1 appendino  
- 1 portarotolo

LOUNGE

FLAT

DELICATA

MINIMAL  
INOX

'900

SQ

FORMA

ARTE

SUITE

EPOCA

ACCESSORI

IDROSCOPINI

## RICAMBI



**AC 66 AR**  
Scopino da bagno.



**ACGL 10**  
Portasapone in vetro.



**ACGL 15**  
Bicchiere in vetro.



**ACGL 13**  
Dispenser in vetro.

# SQ



**SQ 18**  
Supporto doppio in ottone cromato completo di bicchiere e dispenser in vetro.



**SQ 13**  
Dispenser per sapone liquido in vetro con supporto in ottone cromato.



**SQ 17**  
Supporto doppio in ottone cromato completo di bicchiere e portasapone in vetro.



**SQ 16**  
Portabicchiere doppio in ottone cromato con bicchieri in vetro.



**SQ 15**  
Portabicchiere in ottone cromato con bicchiere in vetro.



**SQ 10**  
Portasapone in vetro con supporto in ottone cromato.



**SQ 50**  
Appendino in ottone cromato.



**SQ 44**  
Portasalviette ad anello in ottone cromato.



**SQ 60**  
Portarotolo in ottone cromato.



**SQ 62**  
Portarotolo di ricambio in ottone cromato.



**SQ 66**  
Portascopino in ceramica con supporto in ottone cromato.



# ACCESSORI BAGNO



**SQ 20**  
Mensola in vetro con supporti in ottone cromato, dimensione 10x49 cm.



**SQ 40**  
Portasalviette in ottone cromato, lunghezza cm 40.



**SQ 30**  
Portasalviette in ottone cromato, lunghezza cm 60.



**SQ 33**  
Portasalviette doppio in ottone cromato, lunghezza cm 60.



**SQ 70**  
Portasalviette multiplo in ottone cromato, lunghezza cm 60.



**SQ SET 8P**  
Set serie SQ composto da 8 accessori:  
- 2 portasapone  
- 1 portabicchiere  
- 1 portasalviette cm 60  
- 1 portasalviette cm 40  
- 1 portasalviette ad anello  
- 1 appendino  
- 1 portarotolo

LOUNGE

FLAT

DELICATA

MINIMAL  
INOX

'900

SQ

FORMA

ARTE

SUITE

EPOCA

ACCESSORI

IDROSCOPINI

## RICAMBI



**AC 66 AR**  
Scopino da bagno.



**ACGL 10**  
Portasapone in vetro.



**ACGL 13**  
Dispenser in vetro.



**ACGL 15**  
Bicchiere in vetro.

# FORMA



**FR 18**

Supporto doppio in ottone cromato completo di bicchiere e dispenser in vetro.



**FR 13**

Dispenser per sapone liquido in vetro con supporto in ottone cromato.



**FR 17**

Supporto doppio in ottone cromato completo di bicchiere e portasapone in vetro.



**FR 16**

Portabicchiere doppio in ottone cromato con bicchieri in vetro.



**FR 15**

Portabicchiere in ottone cromato con bicchiere in vetro.



**FR 10**

Portasapone in vetro con supporto in ottone cromato.



**FR 11**

Portasapone in ottone cromato.



**FR 50**

Appendino in ottone cromato.



**FR 44**

Portasalviette ad anello in ottone cromato.



**FR 60**

Portarotolo in ottone cromato.



**FR 62**

Portarotolo di ricambio in ottone cromato.



**FR 66**

Portascopino in ceramica con supporto in ottone cromato.

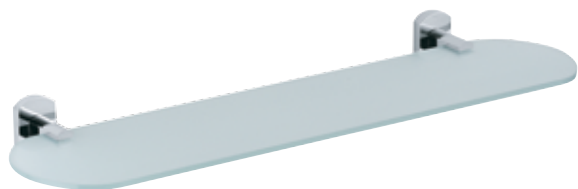

**FR 20**  
Mensola in vetro con supporti in ottone cromato, dimensione 12x52,5 cm.



**FR 40**  
Portasalviette in ottone cromato, lunghezza cm 40.



**FR 30**  
Portasalviette in ottone cromato, lunghezza cm 60.



**FR 33**  
Portasalviette doppio in ottone cromato, lunghezza cm 60.

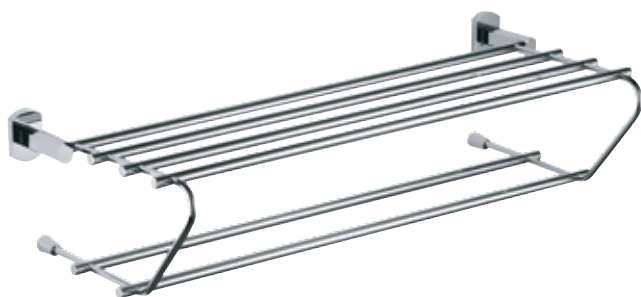

**FR 70**  
Portasalviette multiplo in ottone cromato, lunghezza cm 60.



**FR SET 8P**  
Set serie SQ composto da 8 accessori:  
- 2 portasapone  
- 1 portabicchiere  
- 1 portasalviette cm 60  
- 1 portasalviette cm 40  
- 1 portasalviette ad anello  
- 1 appendino  
- 1 portarotolo

LOUNGE

FLAT

DELICATA

MINIMAL  
INOX

'900

SQ

FORMA

ARTE

SUITE

EPOCA

ACCESSORI

IDROSCOPINI

## RICAMBI



**AC 66 AR**  
Scopino da bagno.



**ACGL 10**  
Portasapone in vetro.



**ACGL 13**  
Dispenser in vetro.



**ACGL 15**  
Bicchiere in vetro.

# ARTE



**AR 13**  
Dispenser per sapone liquido in vetro con supporto in ottone cromato.



**AR 15**  
Portabicchiere in ottone cromato con bicchiere in vetro.



**AR 10**  
Portasapone in vetro con supporto in ottone cromato.



**AR 50**  
Appendino in ottone cromato.



**AR 44**  
Portasalviette ad anello in ottone cromato.

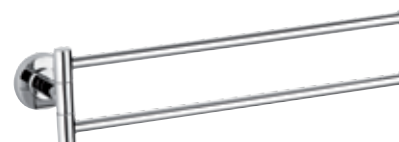

**AR 36**  
Portasciugamano a braccia girevoli in ottone cromato, lunghezza cm 45.



**AR 60**  
Portarotolo in ottone cromato.



**AR 61**  
Portarotolo di ricambio in ottone cromato.



**AR 62**  
Portarotolo di ricambio in ottone cromato.



**AR 66**  
Portascopino in ceramica con supporto in ottone cromato.

# ACCESSORI BAGNO

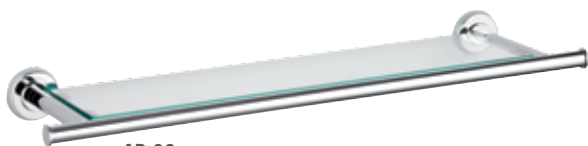

## AR 20

Mensola in vetro con supporti in ottone cromato, dimensione 17x60 cm.



## AR 40

Portasalviette in ottone cromato, lunghezza cm 40.



## AR 30

Portasalviette in ottone cromato, lunghezza cm 60.



## AR 33

Portasalviette doppio in ottone cromato, lunghezza cm 60.

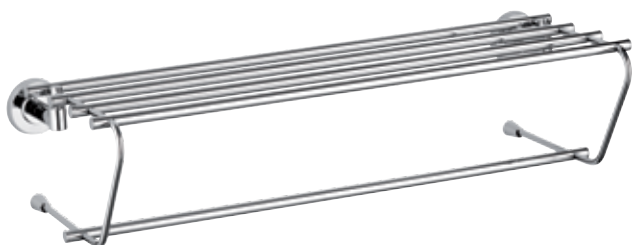

## AR 70

Portasalviette multiplo in ottone cromato, lunghezza cm 60.



## AR SET 8P

Set serie SQ composto da 8 accessori:

- 2 portasapone
- 1 portabicchiere
- 1 portasalviette cm 60
- 1 portasalviette cm 40
- 1 portasalviette ad anello
- 1 appendino
- 1 portartolo

LOUNGE

FLAT

DELICATA

MINIMAL  
INOX

'900

SQ

FORMA

ARTE

SUITE

EPOCA

ACCESSORI

IDROSCOPINI

## RICAMBI



## AC 66 AR

Scopino da bagno.



## ACGL 10

Portasapone in vetro.



## ACGL 13

Dispenser in vetro.



## ACGL 15 AE

Bicchiere in vetro.



# SUITE



**SU 13**  
Dispenser per sapone liquido  
in vetro con supporto in ottone  
cromato.



**SU 15**  
Portabicchiere in ottone cromato  
con bicchiere in vetro.



**SU 10**  
Portasapone in vetro con supporto  
in ottone cromato.



**SU 50**  
Appendino in ottone  
cromato.



**SU 44**  
Portasalviette ad anello  
in ottone cromato.



**SU 60**  
Portarotolo in ottone cromato.



**SU 62**  
Portarotolo di ricambio in  
ottone cromato.



**SU 66**  
Portascopino in acciaio INOX.



## SU 20

Mensola in vetro con supporti in ottone cromato, dimensione 11x49,5 cm.



## SU 40

Portasalviette in ottone cromato, lunghezza cm 40.



## SU 30

Portasalviette in ottone cromato, lunghezza cm 60.



## SU 33

Portasalviette doppio in ottone cromato, lunghezza cm 60.



## SU SET 8P

Set serie SQ composto da 8 accessori:

- 2 portasapone
- 1 portabicchiere
- 1 portasalviette cm 60
- 1 portasalviette cm 40
- 1 portasalviette ad anello
- 1 appendino
- 1 portarotolo

LOUNGE

FLAT

DELICATA

MINIMAL  
INOX

'900

SQ

FORMA

ARTE

SUITE

EPOCA

ACCESSORI

IDROSCOPINI

## RICAMBI



## AC 66 SU

Scopino da bagno.



## ACGL 10

Portasapone in vetro.



## ACGL 13

Dispenser in vetro.



## ACGL 15

Bicchiere in vetro.

# EPOCA

IN CERAMICA  
BIANCA



**EP 13**  
Dispenser per sapone liquido  
in ceramica con supporto in  
ottone cromato.



**EP 15**  
Portabicchiere in ottone cromato  
con bicchiere in ceramica.



**EP 10**  
Portasapone in ceramica con  
supporto in ottone cromato.



**EP 50**  
Appendino in ottone  
cromato.



**EP 44**  
Portasalviette ad anello  
in ottone cromato.



**EP 60**  
Portarotolo in ottone cromato.



**EP 62**  
Portarotolo di ricambio in  
ottone cromato.



**EP 66**  
Portascopino in ceramica con  
supporto in ottone cromato.

# ACCESSORI BAGNO



**EP 20**  
Mensola in vetro con supporti in ottone cromato, dimensione 12x52,5 cm.



**EP 40**  
Portasalviette in ottone cromato, lunghezza cm 40.



**EP 30**  
Portasalviette in ottone cromato, lunghezza cm 60.



**EP 33**  
Portasalviette doppio in ottone cromato, lunghezza cm 60.



**EP SET 8P**  
Set serie SQ composto da 8 accessori:  
- 2 portasapone  
- 1 portabicchiere  
- 1 portasalviette cm 60  
- 1 portasalviette cm 40  
- 1 portasalviette ad anello  
- 1 appendino  
- 1 portarotolo

LOUNGE

FLAT

DELICATA

MINIMAL  
INOX

'900

SQ

FORMA

ARTE

SUITE

EPOCA

ACCESSORI

IDROSCOPINI

## RICAMBI



**AC 66 AR**  
Scopino da bagno.



**ACCE 10 MI**  
Portasapone ceramica.



**ACCE 13 FT**  
Dispenser in ceramica.



**ACCE 15 MI**  
Bicchiere in ceramica.

# ACCESSORI BAGNO

## ACCESSORI



**RB 211**  
Portasapone piccolo rettangolare in  
ottone cromato.  
Dimensioni: 12x9x3 cm.



**RB 271**  
Portasapone piccolo angolare in  
ottone cromato.  
Dimensioni: 17x11,5x3,2 cm.



**RB 281**  
Portasapone piccolo ovale in ottone  
cromato.  
Dimensioni: 16x10x3,4 cm.



**RB 273**  
Portasapone angolare in ottone  
cromato.  
Dimensioni: 20,5x17,5x4,5 cm.



**RB 212**  
Portasapone grande rettangolare in  
ottone cromato.  
Dimensioni: 20,5x11,5x3 cm.



**RB 272**  
Portasapone grande angolare in  
ottone cromato.  
Dimensioni: 22x14,3x6 cm.



**RB 282**  
Portasapone grande ovale in ottone  
cromato.  
Dimensioni: 24,5x11,8x3,4 cm.



**RB 277**  
Portasapone doppio angolare in  
ottone cromato.  
Dimensioni: 30,5 x19x19,5 cm.





**RB 430**  
Portasalvietta in ottone cromato da cm 60.



**RB 440**  
Portasalvietta in ottone cromato da cm 40.



**RB 480**  
Maniglione vasca con portasapone in ottone cromato. Dimensioni: 43x21x13 cm.



**RB 313**  
Appendiabiti in linea a tre ganci in ottone cromato. Dimensioni: 32x3 cm.



**RB 312**  
Appendiabiti in linea a due ganci in ottone cromato. Dimensioni: 20x3 cm.



**RB 310**  
Appendiabito a muro minimale.



**RB 470**  
Portasciugamano multiplo in ottone cromato cm 60.



**RB 490**  
Sistema filo stendibiancheria in ottone cromato.



**RB 495**  
Portasalviette in acciaio INOX. Dimensioni: 27x14x6 cm.



**RB 495 A**  
Porta kleenex in Abs cromato. Dimensioni: 25,5x14x6,5 cm.



**RB 496**  
Porta sacchetti igienici in Abs. Dimensioni: 13,5x10x2,5 cm.



**RB 711**  
Bilancia elettronica pesapersona pedana in cristallo temperato.



**RB 700**  
Bilancia elettronica pesapersona pedana in cristallo temperato.

LOUNGE

FLAT

DELICATA

MINIMAL  
INOX

'900

SQ

FORMA

ARTE

SUITE

EPOCA

ACCESSORI

IDROSCOPINI

## ACCESSORI



### RB 550

Piantana porta asciugamani a due posizioni in ottone cromato, altezza totale 98 cm.



### RB 555

Piantana porta asciugamani a due posizioni con porta scopino in ottone cromato, altezza totale 98 cm.



### RB 560

Piantana porta asciugamani a due posizioni con porta scopino e porta rotolo in ottone cromato, altezza totale 98 cm.



### RB 465

Portascopino sospeso in ottone cromato.



### RB 466

Portascopino in acciaio INOX.



### RB 501

Portarifiuti, 3 litri, in acciaio INOX. Altezza 26 cm, Ø 17 cm.



### RB 502

Portarifiuti, 5 litri, in acciaio INOX. Altezza 29 cm, Ø 20 cm.



### RB 503

Portarifiuti, 12 litri, in acciaio INOX. Altezza 39 cm, Ø 25 cm.



### RB 505

Portarifiuti rettangolare, 5 litri, in acciaio INOX. Dimensioni: 30x22,5x14 cm.



### RB 600

Dispenser per liquidi in acciaio INOX, capacità 730 ml. Dimensioni: 18,3x10,7x6 cm.



### RB 601

Dispenser per liquidi con sistema di chiusura di sicurezza, capacità 330 ml. Dimensioni: 19x8x7,2 cm.



### RB 602

Doppio dispenser per liquidi con sistema di chiusura di sicurezza, capacità 330+330 ml. Dimensioni: 19x16x7,2 cm.



### RB 605 BI

Doppio dispenser per liquidi bianco in ABS. Dimensioni: 23x13,8x8 cm.



**RB 630**  
Specchio ingranditore a doppia faccia, a muro Ø 15 cm.



**RB 635**  
Specchio ingranditore a doppia faccia, a muro Ø 21 cm.



**RB 640**  
Specchio ingranditore a doppia faccia da appoggio Ø 15 cm.



**RB 645**  
Specchio ingranditore a doppia faccia da appoggio Ø 21 cm.



**AH77LED**  
Specchio ingranditore retroilluminato, accensione al tocco, spegnimento automatico, a batteria. Ø 18 cm, estensione max 34 cm.



**AH77QLED**  
Specchio ingranditore retroilluminato, accensione al tocco, spegnimento automatico, a batteria. 18x18 cm, estensione max 34 cm.



**AH75LED**  
Specchio ingranditore retroilluminato, con spina e interruttore. Ø 21,5 cm, estensione max 26 cm.



**AH75QLED**  
Specchio ingranditore retroilluminato, con spina e interruttore. 21x21 cm, estensione max 35 cm.



LOUNGE

FLAT

DELICATA

MINIMAL  
INOX

'900

SQ

FORMA

ARTE

SUITE

EPOCA

ACCESSORI

IDROSCOPINI

# IDROSCOPINI



## IDROSCOPINI



### RB 100

Idroscoopino a pulsante "Lux" in ottone cromato, con impugnatura liscia 1/2".



### RB 120

Idroscoopino a pulsante quadrata, serie "SQ", in ottone cromato, 1/2".



### 336 L

Rubinetto d'arresto serie Minimal, con supporto doccia in ottone cromato, per flessibile con attacco conico.



### 336 S

Rubinetto d'arresto serie SQ, con supporto doccia in ottone cromato, per flessibile con attacco conico.

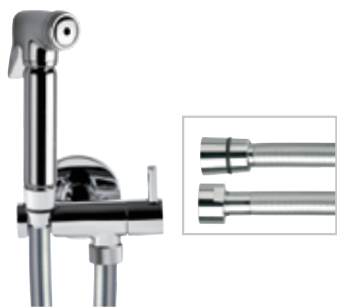

**RB 100 S01**

Set composto da: idroscopino a pulsante, flessibile con attacco conico cm 120 metallizzato in PVC, rubinetto ad angolo Minimal con vitone ceramico e supporto doccia "Lux" in ottone cromato.

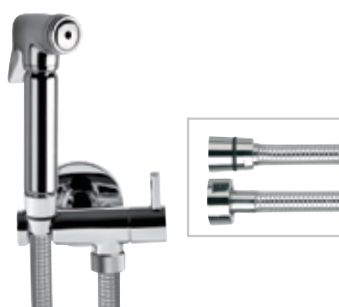

**RB 100 S02**

Set composto da: idroscopino a pulsante, flessibile con attacco conico cm 120 in PVC con piattina cromata, rubinetto d'arresto Minimal con vitone ceramico e supporto doccia "Lux" in ottone cromato.



**RB 100 TE**

Set composto da: idroscopino a pulsante in ottone cromato, flessibile conico cm 120, rubinetto temporizzato 1/2" in ottone cromato, tempo d'apertura 6-8 secondi.

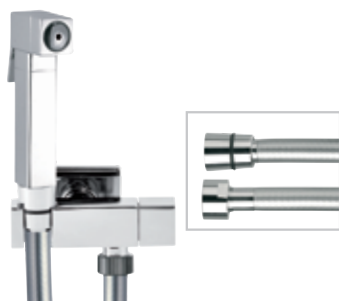

**RB 120 S01**

Set composto da: idroscopino a pulsante, flessibile con attacco conico cm 120 metallizzato in PVC, rubinetto ad angolo SQ con vitone ceramico e supporto doccia "Lux" in ottone cromato.

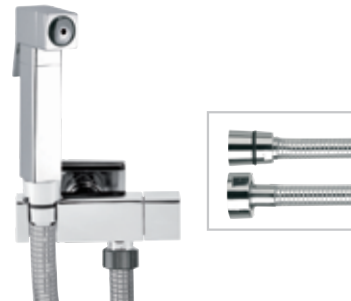

**RB 120 S02**

Set composto da: idroscopino a pulsante, flessibile con attacco conico cm 120 in PVC con piattina cromata, rubinetto d'arresto SQ con vitone ceramico e supporto doccia "Lux" in ottone cromato.



LOUNGE

FLAT

DELICATA

MINIMAL  
INOX

'900

SQ

FORMA

ARTE

SUITE

EPOCA

ACCESSORI

IDROSCOPINI





# ESPOSITORI

## ESPOSITORI DA PAVIMENTO



ESP Q



ESP VERT

## ESPOSITORE PER RUBINETTERIA AMBIENT



ESP AMB



ESPLT 72

Rubinetto con tecnologia Touch-Me da esposizione e dimostrazione. Utilizzabile in mancanza di possibilità di collegamento del rubinetto Touch alla rete idrica, questa versione DEMO simula esattamente, toccando il miscelatore, l'apertura e chiusura dell'acqua tramite l'accensione e spegnimento di una luce azzurra posizionata in maniera molto visibile nella zona aeratore. L'articolo è rilavorato per essere esclusivamente dimostrativo.

## CONDIZIONI GENERALI DI VENDITA

### Accettazione ordini

La commissione è sempre subordinata all'approvazione della Casa Venditrice. Le condizioni di vendita si intendono accettate dal committente al momento del conferimento dell'ordine e con il ritiro del materiale.

### Consegne e rese

La merce è resa franco deposito di partenza e viaggia a rischio e pericolo del committente. Il venditore si riserva di poter effettuare consegne parziali.

### Spedizioni

Le quantità devono essere verificate all'atto del ricevimento ed eventuali discordanze vanno annotate sulla bolla di consegna mediante accettazione "con riserva". Eventuali spese aggiuntive per giacenze sono a carico del committente.

### Imballaggio

L'imballaggio è effettuato con imballi standard ed eventualmente su pallets a carico del committente.

### Termini di consegna

I termini di consegna, eventualmente indicati, sono sempre forniti a puro titolo indicativo e non vincolante.

### Prezzi

I prezzi riportati nei listini non sono vincolanti. La Remer Rubinetterie S.p.A. si riserva la facoltà di variare i prezzi di vendita in qualsiasi momento senza nessun preavviso.

### Pagamenti

L'eventuale ritardo del pagamento comporterà l'addebito di interessi al tasso corrente. La Remer Rubinetterie S.p.A. si riserva la facoltà di sospendere

eventuali ordini in corso in presenza di pagamenti irregolari. Le contestazioni di qualsiasi valore o entità non danno diritto alla sospensione dei pagamenti.

### Reclami

Non si accettano reclami o resi merce dopo 7 giorni dal ricevimento della stessa. I reclami devono pervenire entro i termini indicati tramite lettera raccomandata e via fax. Ogni reso deve essere preventivamente autorizzato dalla Remer Rubinetterie S.p.A. che fornirà istruzioni in merito.

### Caratteristiche tecniche

La Remer Rubinetterie S.p.A. si riserva la facoltà di apportare ogni variazione agli articoli senza nessun preavviso.

### Riservato dominio

I prodotti rimangono di proprietà della Remer Rubinetterie S.p.A. fino al totale pagamento del prezzo in conformità a quanto previsto dal C.C.

### Responsabilità

La Remer Rubinetterie S.p.A. non fornisce garanzie circa l'impiego errato o inadatto dei propri prodotti. Qualora il materiale risultasse difettoso per vizi di fabbricazione riconosciuti a seguito di perizia, la Remer Rubinetterie S.p.A. si riserva di sostituirlo o accreditarne il valore senza che la propria responsabilità si possa estendere in nessun caso ad altri oneri.

### Foro

Per qualsiasi controversia il Foro competente è quello di Milano.

Stampato nel mese di Agosto 2018

Remer Rubinetterie S.p.A. si riserva il diritto di effettuare modifiche tecniche ed estetiche sui prodotti, senza preavviso alla clientela.







Remer Rubinetterie S.p.A.  
 Via Leonardo da Vinci, 83  
 20062 Cassano d'Adda (MI) Italy  
 Tel. +39 0363 364 211  
 E-Mail: info@remer.eu  
 www.remer.eu

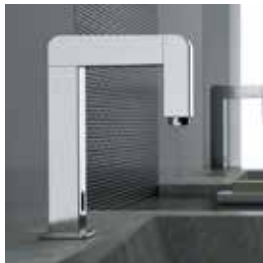
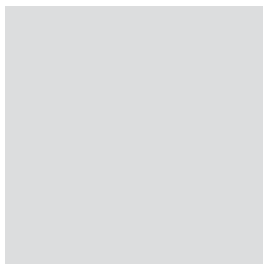
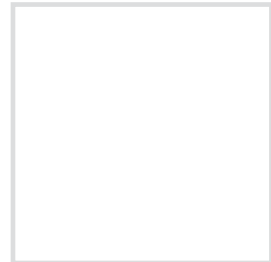

Ufficio Commerciale Italia:  
 Tel. 0363 364 333  
 Fax 0363 63 575  
 Export Commercial Department:  
 Tel. +39 0363 364 364  
 Fax +39 0363 364 300

